

# BBT Automotive Components GmbH

*BBT* hat sich im Verlauf von 2 Jahrzehnten durch Qualität, Wettbewerbsfähigkeit, Kompetenz und Zuverlässigkeit im Ersatzteilmarkt als starke Marke etabliert.

*BBT* ist ständig im Einsatz, um Kunden freundlich und fachkundig zu betreuen sowie mit aktuellen Produktinformationen zu versorgen. Dabei stehen termingerechte Lieferungen und einwandfreie Qualität immer im Vordergrund.



*BBT* is a strong and well established brand which kept its focus on quality, reliability and competitiveness in the automotive aftermarket during a history of two decades.

*BBT* is fully committed to provide customers with an excellent service of experts and detailed information about all products. Priority is the product quality along with deliveries on time at competitive prices to serve our customers needs.



## Inhaltsverzeichnis

### List of Contents

#### *Zündkabelsätze für LPG / CNG*

Seite / page	3 - 4.....	Produktinformation / product information
Seite / page	5 - 16.....	Anwendungsliste / application list
Seite / page	17 - 20.....	Abbildungen / pictures
Seite / page	21 - 22.....	Vergleichsliste / cross reference list

## Allgemeine Informationen

### General information

Durch die ständige Weiterentwicklung des Programms ist es möglich, dass sich unsere Produktdaten ändern. BBT Automotive Components GmbH behält sich das Recht vor, Ausführung und Artikelnummern der in diesem Katalog gezeigten Produkte jederzeit und ohne Ankündigung zu ändern. Alle Rechte vorbehalten.

Die Gegenüberstellung von BBT Artikelnummern zu Fahrzeugherstellern oder zu Herstellern von anderen Marken dient ausschließlich zu Vergleichszwecken. Technische Unterschiede sind bauart- und herstellerbedingt möglich, wofür eine Gewährleistung ausgeschlossen ist. Verbindlich bei der Bestellung ist jeweils die BBT Artikelnummer.

Due to continued research and development of our program, BBT Automotive Components GmbH reserves the right to modify all product data without further notice. All rights reserved.

The cross-reference of BBT article numbers to car manufacturers or manufacturers of other brands is only for comparative purposes. Technical differences may occur in relation to construction and manufacturer, therefore warranty can not be granted. When placing the order, the BBT article number is binding.

Bei Rückfragen stehen wir Ihnen gerne jederzeit zur Verfügung.  
In case of queries do not hesitate to contact us.



#### *Headquarters*

BBT Automotive Components GmbH  
Gewerbering 12  
91629 Weihenzell  
Germany  
Info@bbt-automotive.de  
Phone: +49(0)9802 - 95211 0  
Fax: +49(0)9802 - 95211 95

## Zündkabelsätze für LPG / CNG

Der Trend zum Gaskraftstoff steigt stetig an. Immer mehr Autofahrer lassen ihr Fahrzeug auf den Betrieb mit Autogas umrüsten. Die Gründe dafür sind: günstigere Betriebskosten, sparsame Antriebsart, ausgebautes Tankstellennetz und umweltschonend. Der Gasbetrieb birgt jedoch häufig Probleme, wie Mischungsverhältnis des LPG-Gases, keine Abstimmung zwischen Motor und Gas, höhere Temperaturen, stärkere Belastung der Zündleitungen und Zündspulen als bei Benzinbetrieb.

BBT Zündleitungssätze haben für die meisten Gasmotoren einen metallischen Leiter, der sowohl einen elektrischen Widerstand als auch eine elektrische Induktivität aufweist. Die Zündleitungen liefern somit einen höheren Zündstrom an die Zündkerze.

Die Zündleitungen sind so konzipiert, dass die Phasenverschiebung zwischen Strom und Spannung im Zündfunken minimiert und die Funkenleistungsausbeute maximiert wird.

Umfangreiche Untersuchungen am Motorprüfstand haben gezeigt, dass die Technologie der BBT Zündkabel für Gasmotoren einen Vorteil gegenüber vergleichbaren Zündleitungen darstellen. Ein höherer Funkenstrom erzeugt eine schnellere Verbrennung, wodurch sich ein geringerer Kraftstoffverbrauch und in Folge eine geringere CO<sub>2</sub> Belastung der Atmosphäre ergibt

Das BBT Zündkabelprogramm für LPG (Liquefied Petroleum Gas) und CNG (Compressed Natural Gas) Motoren, umfasst 32 Artikel für 460 verschiedene Fahrzeugmodelle.



Eigenschaften:

- speziell für Monovalent & Bivalent Systeme
- Zündkabel geeignet für Hochtemperaturbetrieb
- Passgenaue Kabellängen und Anschlüsse
- beste Isolation gegen Flüssigkeiten
- hochwertiges Zweilagigen-Silikon Zündkabel
- Made in Germany
- schnellere Verbrennung
- geringerer Kraftstoffverbrauch
- CO<sub>2</sub>-sparend

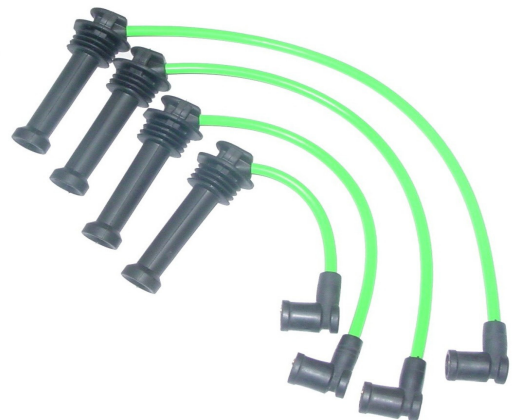

## Ignition Cable Sets for Gas Engines

The trend for natural gas fuel is steadily increasing. More and more car drivers let their cars re-equip for natural gas, by the following reasons: less operating costs, the economical way of drive, a well-built petrol station network environmentally friendly. However, a natural gas drive involves also problems like the mixture of LPG gas, no adjustment between engine and gas, higher temperatures and impact on the ignition cables and ignition coils, compared to petrol-fuelled vehicles.

Therefore, BBT offers ignition cables with a metallic conductor for the most gas vehicles which acts as a resistor and an inductor at the same time, to create an internal resonating circuit. This provides a strong and powerful spark current to the spark plug.

The BBT spark plug cables for natural gas engines are built in such a way, that the phase shift is minimized in order to achieve maximum electrical power to the spark.

Extensive research in the laboratory and on the engine dynamometer has shown that the BBT spark plug cables for natural gas engines are superior to other spark plug cables. A spark with higher electrical current causes faster combustion, lower fuel consumption and, as a consequence, the CO<sub>2</sub> emission to the atmosphere is reduced.

The BBT range of ignition cables for LPG (Liquefied Petroleum Gas) and CNG (Compressed Natural Gas) engines, includes 32 items for 460 different vehicles.



### Advantages:

- Especially for mono-fuel and bi-fuel systems
- Ignition cables suitable for high temperature
- Exact cable lengths and connectors
- High-quality two-layer silicone ignition cable
- Made in Germany
- Faster combustion
- Less fuel consumption
- Less CO<sub>2</sub> emission

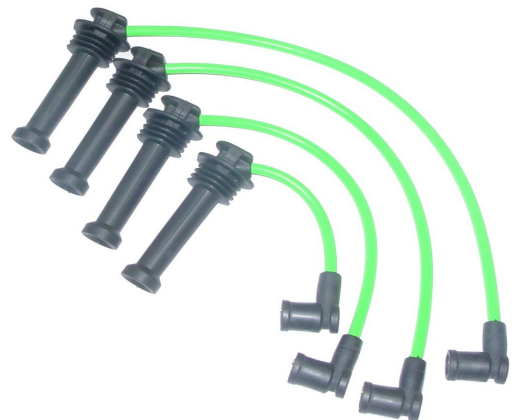

Typ Type	Motornummer Engine-No.	Baujahr Year	Liter Litre	Zyl. Cyl.	KW	Vert. Distr.	BBT-Nr. BBT-No.	Abb. Pict.
-------------	---------------------------	-----------------	----------------	--------------	----	-----------------	--------------------	---------------

### Audi

A1 1.2 TFSI	CBZA	05.10 ->	1,2	4	63	M4	ZKG0328	027
A1 1.2 TFSI	CBZA	05.10 ->	1,2	4	63	M4	ZKG0314	001
A1 1.2 TFSI Sportback	CBZA	01.12 ->	1,2	4	63	M4	ZKG0314	001
A1 Sportback 1.2 TFSI	CBZA	01.12 ->	1,2	4	63	M4	ZKG0328	027
A3 1.2 TFSI Cabriolet	CBZB	03.10 ->	1,2	4	77	M4	ZKG0314	001
A3 1.2 TSI	CBZB	04.10 - 08.12	1,2	4	77	M4	ZKG0328	027
A3 1.2 TSI	CBZB	04.10 ->	1,2	4	77	M4	ZKG0314	001
A3 1.2 TSI Sportback	CBZB	04.10 - 08.12	1,2	4	77	M4	ZKG0314	001
A3 1.6	AEH, AKL, APF	09.96 - 08.00	1,6	4	74	M4	ZKG0359	003
A3 1.6	BGU, BSE, BSF, CCSA	05.03 - 08.12	1,6	4	75	M4	ZKG3000	025
A3 1.6 Cabriolet	BSE	09.08 ->	1,6	4	75	M4	ZKG3000	025
A3 1.6 Sportback	BGU, BSE, BSF, CCSA	09.04 ->	1,6	4	75	M4	ZKG3000	025
A3 Cabriolet 1.2 TFSI	CBZB	03.10 ->	1,2	4	77	M4	ZKG0328	027
A3 Sportback 1.2 TSI	CBZB	04.10 ->	1,2	4	77	M4	ZKG0328	027
A4 1,6	ALZ	07.00 - 11.00	1,6	4	75	M4	ZKG0359	003
A4 1.6	ADP, AHL, ANA, ARM	01.95 - 07.00	1,6	4	74	M4	ZKG0359	003
A4 1.6	ALZ	11.00 - 12.04	1,6	4	75	M4	ZKG0359	003
A4 1.6	ALZ	11.04 ->	1,6	4	75	M4	ZKG0359	003
A4 2.4	AGA, ALF, AML, APS, ARJ	03.97 - 11.00	2,4	6	121	M4	ZKG0357	002
A4 2.4	AJG, AMM, APZ	08.97 - 11.00	2,4	6	120	M4	ZKG0357	002
A4 2.4	AMM	09.01 - 12.04	2,4	6	120	M4	ZKG0357	002
A4 2.4 Avant	AGA, ALF, AML, APS, ARJ	03.97 - 09.01	2,4	6	121	M4	ZKG0357	002
A4 2.4 Avant	AJG, AMM, APZ	08.97 - 09.01	2,4	6	120	M4	ZKG0357	002
A4 2.4 Cabriolet	AMM	04.02 - 12.05	2,4	6	120	M4	ZKG0357	002
A4 2.4 Cabriolet	BDV	04.02 - 12.05	2,4	6	125	M4	ZKG0357	002
A4 2.4 Quattro	AGA, ALF, AML, APS, ARJ	03.97 - 11.00	2,4	6	121	M4	ZKG0357	002
A4 2.4 Quattro	APZ	03.97 - 11.00	2,4	6	120	M4	ZKG0357	002
A4 2.8	ACK, ALG, AMX, APR, AQD	10.96 - 11.00	2,8	6	142	M4	ZKG0357	002
A4 2.8 Avant	ACK, ALG, AMX, APR, AQD	10.96 - 11.00	2,8	6	142	M4	ZKG0357	002
A4 2.8 Quattro	ACK, ALG, AMX, APR, AQD	10.96 - 11.00	2,8	6	142	M4	ZKG0357	002
A6 2.0 Avant	ALT	08.01 - 01.05	2,4	6	96	M4	ZKG0357	002
A6 2.4	AGA, ALF, AML, APS, ARJ	02.97 - 01.05	2,4	6	121	M4	ZKG0357	002
A6 2.4	AJG, AMM, APZ	02.97 - 01.05	2,4	6	120	M4	ZKG0357	002
A6 2.4	ALW, ARN, ASM	07.98 - 01.05	2,4	6	100	M4	ZKG0357	002
A6 2.4	APC	02.97 - 01.05	2,4	6	115	M4	ZKG0357	002
A6 2.4	BDV	08.01 - 01.05	2,4	6	125	M4	ZKG0357	002
A6 2.4 Quattro	AGA, ALF, AML, APS, ARJ	02.97 - 01.05	2,4	6	121	M4	ZKG0357	002
A6 2.4 Quattro	AJG, APZ	02.94 - 01.05	2,4	6	120	M4	ZKG0357	002
A6 2.4 Quattro	APC	08.98 - 07.99	2,4	6	115	M4	ZKG0357	002
A6 2.4 Quattro	BDV	08.01 - 01.05	2,4	6	125	M4	ZKG0357	002
A8 2.8	ACK, ALG, AMX, APR, AQD	04.96 - 09.02	2,8	6	142	M4	ZKG0357	002
A8 2.8 Quattro	ACK, AMX, APR, AQD	04.96 - 09.02	2,8	6	142	M4	ZKG0357	002

### BMW

316 Ci Coupe (E46)	M43 B16 (16 4 E3)	04.00 ->	1,6	4	77	M4	ZKG0940	007
316 g Compact (E36)	---	12.95 - 08.00	1,6	4	75	M4	ZKG0949	008
316 i (E36)	M43 B16	07.93 - 02.98	1,6	4	75	M4	ZKG0949	008
316 i (E46)	M43 B16, M43 B16 (16 4 E3)	04.00 - 02.05	1,6	4	77	M4	ZKG0940	007
316 i (E46)	M43 B19 TU, M43 16 4 E3	09.98 - 02.05	1,9	4	77	M4	ZKG0940	007
316 i Compact (E36)	M43 B19 TU, M43 16 4 E3	12.98 - 08.00	1,9	4	77	M4	ZKG0940	007
316 i Compact (E36)	M43 B16	03.94 - 08.00	1,6	4	75	M4	ZKG0949	008
316 i Coupe (E36)	M43 B16	09.93 - 04.99	1,6	4	75	M4	ZKG0949	008
316 i Tooring (E36)	M43 B16	01.96 - 10.99	1,6	4	75	M4	ZKG0949	008
316 ti Compact (E36)	N42 B18, N46 B18A	06.01 - 02.05	1,8	4	85	M4	ZKG0940	007
318 Ci Coupe (E46)	M43 B19	11.99 - 09.01	1,9	4	87	M4	ZKG0940	007
318 i (E36)	M43 B18	10.93 - 02.98	1,8	4	85	M4	ZKG0949	008
318 i (E46)	M43 B19, M43 B19 TU	02.98 - 09.01	1,9	4	87	M4	ZKG0940	007
318 i Cabriolet (E36)	M43 B18	01.94 - 04.99	1,8	4	85	M4	ZKG0949	008

Typ Type	Motornummer Engine-No.	Baujahr Year	Liter Litre	Zyl. Cyl.	KW	Vert. Distr.	BBT-Nr. BBT-No.	Abb. Pict.
318 i Touring (E36)	M43 B18	07.95 - 10.99	1,8	4	85	M4	ZKG0949	008
318 i Touring (E46)	M43 B19, M43 B19 TU	10.99 - 09.01	1,9	4	87	M4	ZKG0940	007
318 is (E36)	M44 B19	09.95 - 02.98	1,9	4	103	M4	ZKG0959	009
318 is (E36)	M42 B18	03.93 - 09.97	1,8	4	103	M4	ZKG0959	009
318 is Coupe (E36)	M42 B18	03.92 - 10.95	1,8	4	103	M4	ZKG0959	009
318 is Coupe (E36)	M44 B19	09.95 - 04.99	1,9	4	103	M4	ZKG0959	009
318 ti Compact (E36)	M42 B18	11.94 - 08.95	1,8	4	103	M4	ZKG0959	009
318 ti Compact (E36)	M44 B19	07.95 - 08.00	1,9	4	103	M4	ZKG0959	009
518 g Touring (E34)	M43 B18	11.95 - 06.96	1,8	4	85	M4	ZKG0940	007
518 i (E34)	M43 B18	08.89 - 09.95	1,8	4	85	M4	ZKG0940	007
518 i Touring (E34)	M43 B18	09.94 - 01.97	1,8	4	85	M4	ZKG0940	007
Z3 1.8 Cabriolet	M43 B18	10.95 - 10.98	1,8	4	85	M4	ZKG0949	008
Z3 1.9 Cabriolet	M43 B19 TU, M43 B19 TU	07.98 - 01.03	1,9	4	87	M4	ZKG0949	008
Z3 1.9 Cabriolet	M43 194 E1	01.99 - 01.03	1,9	4	85	M4	ZKG0949	008
Z3 1.9 Cabriolet	M44 B19	10.95 - 03.99	1,9	4	103	M4	ZKG0959	009

### Chevrolet

Aveo 1.2	A 12 XEL	03.11 ->	1,2	4	51	M4	ZKG1115	028
Aveo 1.2	A 12 XER	03.11 ->	1,2	4	63	M4	ZKG1115	028
Aveo 1.2	A 12 XER	03.11 ->	1,2	4	63	M4	ZKG1115	028

### Chrysler

Aveo 1.2	---	04.08 ->	1,2	4	62	M4	ZKG1111	011
Aveo 1.2	F12S3	03.06 ->	1,2	4	53	M4	ZKG1111	011
Crossfire 3.2	EGX	07.03 ->	3,2	6	160	M4	ZKG0437	005
Crossfire Roadster 3.2	EGX	05.04 ->	3,2	6	160	M4	ZKG0437	005
Kalos 1.2	B12S1	03.05 ->	1,2	4	53	M4	ZKG1111	011
Matiz 1.0	B10S1	03.05 ->	1,0	4	49	M4	ZKG1111	011
Matiz 1.0	B10S	03.05 ->	1,0	4	47	M4	ZKG1111	011
Rezzo 1.6	A16DMS	03.05 ->	1,6	4	77	M4	ZKG1107	010
Rezzo 1.6	A16DMS	08.05 ->	1,6	4	79	M4	ZKG1107	010

### Citroën

C3 1.1i	HFX (TU1JP)	02.02 ->	1,1	4	44	M4	ZKG1555	020
C3 1.4i Bivalent	KFV (TU3JP)	02.02 ->	1,4	4	54	M4	ZKG1555	020
C3 1.6 16V	NFU (TU5JP4)	02.02 ->	1,6	4	80	M4	ZKG1555	020
C3 1.6 Pluriel	NFU (TU5JP4)	05.03 ->	1,6	4	80	M4	ZKG1555	020
Evasion 1.8	LFZ (XU7JP)	05.97 - 07.02	1,8	4	73	M4	ZKG1549	018
Evasion 2.0	RFU (XU10J2/C)	06.94 - 07.02	2,0	4	89	M4	ZKG1550	019
Evasion 2.0 Turbo C.T.	RGX (XU10J2TE)	06.94 - 07.02	2,0	4	108	M4	ZKG1550	019
Jumper 2.0 Bus	RFW (XU10J2U)	02.94 - 04.02	2,0	4	80	M4	ZKG1549	018
Jumper 2.0 Kasten	XU10J2U	04.02 ->	2,0	4	81	M4	ZKG1549	018
Saxo 1.0 X	CDZ (TU9M)	05.98 - 06.03	1,0	4	37	M4	ZKG1555	020
Saxo 1.1 X, SX	HDZ (TU1M), HFX (TU1JP)	05.96 - 09.03	1,1	4	44	M4	ZKG1555	020
Saxo 1.1 X, SX	HDZ (TU1M)	05.96 - 09.03	1,1	4	40	M4	ZKG1555	020
Saxo 1.4 VTS	KFW (TU3JP), KFX (TU3JP)	05.96 - 06.03	1,6	4	55	M4	ZKG1555	020
Saxo 1.6 VTL, VTR	NFZ (TU5JP)	05.96 - 06.03	1,6	4	65	M4	ZKG1555	020
Xantia 1.6i	BFZ (XU5JP)	03.93 - 01.98	1,6	4	65	M4	ZKG1549	018
Xantia 1.8i	LFX (XU7JB)	04.97 - 01.98	1,8	4	66	M4	ZKG1549	018
Xantia 1.8i	LFZ (XU7JP)	03.93 - 01.98	1,8	4	74	M4	ZKG1549	018
Xantia 1.8i	LFX (XU7JB)	01.98 - 04.03	1,8	4	66	M4	ZKG1549	018
Xantia 1.8i 16V	LFY (XU7JP4)	06.95 - 01.98	1,8	4	81	M4	ZKG1549	018
Xantia 1.8i 16V	LFY (XU7JP4)	01.98 - 04.03	1,8	4	81	M4	ZKG1549	018
Xantia 1.8i 16V Break	LFY (XU7JP4)	01.98 - 04.03	1,8	4	81	M4	ZKG1549	018
Xantia 1.8i Break	LFZ (XU7JP)	06.95 - 01.98	1,8	4	74	M4	ZKG1549	018
Xantia 1.8i Break	LFX (XU7JB)	01.98 - 04.03	1,8	4	66	M4	ZKG1549	018
Xantia 2.0 Turbo	RGX (XU10J2TE)	06.95 - 01.98	2,0	4	108	M4	ZKG1550	019
Xantia 2.0i	RFX (XU10J2C)	03.93 - 01.98	2,0	4	89	M4	ZKG1550	019
Xantia 2.0i 16V	RFY (XU10J4/Z)	03.93 - 01.98	2,0	4	112	M4	ZKG1550	019

Type	Motornummer Engine-No.	Baujahr Year	Liter Litre	Zyl. Cyl.	KW	Vert. Distr.	BBT-Nr. BBT-No.	Abb. Pict.
Xantia 2.0i 16V	RFV (XU10J4R)	01.98 - 04.03	2,0	4	97	M4	ZKG1550	019
Xantia 2.0i 16V Break	RFV (XU10J4R)	01.98 - 04.03	2,0	4	97	M4	ZKG1550	019
Xantia 2.0i Break	RFX (XU10J2)	06.95 - 01.98	2,0	4	89	M4	ZKG1550	019
Xantia 2.0i Turbo Break	RGX (XU10J2TE)	01.98 - 04.03	2,0	4	108	M4	ZKG1550	019
XM 2.0 Turbo	RGX (XU10J2TE)	05.94 - 10.00	2,0	4	108	M4	ZKG1550	019
XM 2.0i 16V	RFV (XU10J4R)	05.94 - 10.00	2,0	4	97	M4	ZKG1550	019
XM 2.0i Turbo	RGY (XU10J2TE/Z)	09.92 - 06.94	2,0	4	104	M4	ZKG1550	019
Xsara 1.4i	KFW (TU3JP), KFX (TU3JP)	04.97 - 03.05	1,4	4	55	M4	ZKG1555	020
Xsara 1.6i	NFZ (TU5JP)	04.97 - 09.00	1,6	4	65	M4	ZKG1555	020
Xsara 1.8i	LFX (XU7JB)	04.97 - 09.00	1,8	4	66	M4	ZKG1549	018
Xsara 1.8i 16V	LFY (XU7JP4)	02.98 - 09.00	1,8	4	81	M4	ZKG1549	018
Xsara 2.0 16V	RFS (XU10JSRS)	04.97 - 09.00	2,0	4	120	M4	ZKG1550	019
Xsara 2.0i 16V Coupe	RFS (XU10JSRS)	02.98 - 03.05	2,0	4	120	M4	ZKG1550	019
ZX 1.4i	KDX (TU3M/Z), KDZ (TU3M/Z)	03.93 - 06.97	1,4	4	55	M4	ZKG1555	020
ZX 1.6i	BDY (XU5M), BFZ (XU5JP)	03.91 - 06.97	1,6	4	65	M4	ZKG1549	018
ZX 1.8i	LFZ (XU7JP)	07.92 - 06.97	1,8	4	74	M4	ZKG1549	018
ZX 1.8i 16V	LFY (XU7JP4)	01.96 - 06.97	1,8	4	81	M4	ZKG1549	018
ZX 1.9i	DKZ (XU9JA)	03.91 - 06.97	1,9	4	88	M4	ZKG1549	018
ZX 2.0i	RFX (XU10J2C)	07.92 - 06.97	2,0	4	89	M4	ZKG1550	019
ZX 2.0i 16V	RFT (XU10J4/Z)	06.94 - 06-97	2,0	4	110	M4	ZKG1550	019

### Dacia

Dokker 1.6 16V	---	11.12 ->	1,6	4	61	M4	ZKG15112	022
Dokker 1.6 LPG	---	11.13 ->	1,6	4	61	M4	ZKG15112	022
Dokker Express 1.6 16V	---	12.12 ->	1,6	4	61	M4	ZKG15112	022
Dokker Express 1.6 LPG	---	11.13 ->	1,6	4	61	M4	ZKG15112	022
Lodgy 1.6	K7MA8	03.12 ->	1,6	4	61	M4	ZKG15112	022
Lodgy 1.6 LPG	---	11.13 ->	1,6	4	61	M4	ZKG15112	022
Logan Express 1.4	K7J 710	03.09 ->	1,4	4	55	M4	ZKG15112	022
Logan Express 1.6	K7M 710	03.09 ->	1,6	4	64	M4	ZKG15112	022
Logan I 1.4	KJ7 710	09.04 ->	1,4	4	55	M4	ZKG15112	022
Logan I 1.6	K7M 710	09.04 ->	1,6	4	64	M4	ZKG15112	022
Logan II 1.2	---	10.12 ->	1,2	4	55	M4	ZKG1571	021
Logan II 1.2 LPG	D4F 734	10.12 ->	1,2	4	55	M4	ZKG1571	021
Logan MCV I 1.4	KJ7 710	02.07 ->	1,4	4	55	M4	ZKG15112	022
Logan MCV I 1.6	K7M 710	02.07 ->	1,6	4	64	M4	ZKG15112	022
Logan MCV II 1.2	---	02.13 ->	1,2	4	55	M4	ZKG1571	021
Logan MCV II 1.2 LPG	---	02.13 ->	1,2	4	55	M4	ZKG1571	021
Sandero I 1.2 16V	D4F 732	11.08 ->	1,2	4	55	M4	ZKG1571	021
Sandero I 1.2 16V LPG	D4F 732	11.08 ->	1,2	4	55	M4	ZKG1571	021
Sandero I 1.4	KJ7 710	06.08 ->	1,4	4	55	M4	ZKG15112	022
Sandero I 1.4 MPI LPG	K7J 714	01.09 ->	1,4	4	53	M4	ZKG15112	022
Sandero I 1.6	K7M 710	06.08 ->	1,6	4	64	M4	ZKG15112	022
Sandero I 1.6 MPI 85	K7M 800	05.10 ->	1,6	4	62	M4	ZKG15112	022
Sandero II 1.2	D4F 732	01.13 ->	1,2	4	55	M4	ZKG1571	021
Sandero II 1.2 LPG	---	01.13 ->	1,2	4	55	M4	ZKG1571	021
Solenza 1.4	---	02.03 ->	1,4	4	55	M4	ZKG1586	022

### Daewoo

Kalos 1.2	---	04.03 ->	1,2	4	53	M4	ZKG1111	011
Matiz 1.0	---	01.03 ->	1,0	4	47	M4	ZKG1111	011
Rezzo 1.6	A16DMS	09.00 ->	1,6	4	77	M4	ZKG1107	010

### Fiat

500 1.2	169 A4000	10.07 ->	1,2	4	51	M4	ZKG1326	016
500 C 1.2	169 A4000	09.09 ->	1,2	4	57	M4	ZKG1326	016
Brava 1.6 16V	182 A4000	02.96 - 10.01	1,6	4	76	M4	ZKG1392	017
Brava 1.6 16V	182 A6000	10.95 - 10.01	1,6	4	66	M4	ZKG1392	017
Bravo 1.6 16V	182 A4000	03.96 - 10.01	1,6	4	76	M4	ZKG1392	017

Typ Type	Motornummer Engine-No.	Baujahr Year	Liter Litre	Zyl. Cyl.	KW	Vert. Distr.	BBT-Nr. BBT-No.	Abb. Pict.
Bravo 1.6 16V	182 A6000	10.95 - 10.01	1,6	4	66	M4	ZKG1392	017
Cinquecento 1.1 Sporting	176 B2000	10.94 - 01.98	1,1	4	40	DIN	ZKG1322	015
Doblo 1.2	223 A5000	03.01 ->	1,2	4	48	DIN	ZKG1307	014
Doblo 1.4	350 A1000	10.05 ->	1,4	4	57	M4	ZKG1326	016
Doblo 1.6 Natural Power	182 B6000	09.02 ->	1,6	4	76	M4	ZKG1392	017
Doblo Cargo 1.2	223 A5000	03.01 ->	1,2	4	48	DIN	ZKG1307	014
Doblo Cargo 1.4	350 A1000	10.05 ->	1,4	4	57	M4	ZKG1326	016
Doblo Cargo 1.6 Natural Power	182 B6000	09.02 ->	1,6	4	76	M4	ZKG1392	017
Ducato 2.0	RFL	04.02 ->	2,0	4	81	M4	ZKG1549	018
Ducato 2.0	RFW	06.98 - 04.02	2,0	4	80	M4	ZKG1549	018
Ducato 2.0 Combinato, Panorama	RFW	03.94 - 04.02	2,0	4	80	M4	ZKG1549	018
Grande Punto 1.2	199 A4000	10.05 ->	1,2	4	48	M4	ZKG1326	016
Grande Punto 1.4	350 A1000	10.05 ->	1,4	4	57	M4	ZKG1326	016
Idea 1.4	350 A1000	10.05 ->	1,4	4	57	M4	ZKG1326	016
Linea 1.4	350 A1000	06.07 ->	1,4	4	57	M4	ZKG1326	016
Marea 1.6 100 16V	182 A4000	09.96 ->	1,6	4	76	M4	ZKG1392	017
Marea 1.6 100 16V Bipower	185 A3000, 186 A4000	04.99 ->	1,6	4	76	M4	ZKG1392	017
Marea Weekend 1.6 100 16V	182 A4000	09.96 ->	1,6	4	76	M4	ZKG1392	017
Multipla 1.6 100 16V	182 A4000	04.99 ->	1,6	4	76	M4	ZKG1392	017
Multipla 1.6 16V Bipower	182 B6000	10.01 ->	1,6	4	76	M4	ZKG1392	017
Multipla 1.6 16V Bipower	186 A4000	04.99 ->	1,6	4	76	M4	ZKG1392	017
Multipla 1.6 16V Blupower	182 B6000	04.02 ->	1,6	4	70	M4	ZKG1392	017
Multipla 1.6 16V Blupower	186 A3000	04.99 ->	1,6	4	70	M4	ZKG1392	017
Palio Weekend 1.6 16V	178 B3000	04.96 - 02.01	1,6	4	74	M4	ZKG1392	017
Palio Weekend 1.6 16V	182 B6000	02.01 ->	1,6	4	76	M4	ZKG1392	017
Panda 1.1	187 A1000	09.03 ->	1,1	4	40	DIN	ZKG1322	015
Panda 1.2	188 A4000	09.03 ->	1,2	4	44	DIN	ZKG1322	015
Panda 1.2 4x4	188 A4000	10.04 ->	1,2	4	44	DIN	ZKG1322	015
Panda 1.2 Bi-Power	188 A4000	01.07 ->	1,2	4	44	DIN	ZKG1307	014
Punto 1.1 Van	176 B2000	04.96 - 02.00	1,1	4	40	DIN	ZKG1322	015
Punto 1.2 Natural Power	188 A4000	09.03 ->	1,2	4	44	DIN	ZKG1322	015
Punto 55 1.1	176 A6000, 176 B2000	09.93 - 09.99	1,1	4	40	DIN	ZKG1322	015
Punto 60 1.2	176 A7000	01.94 - 09.99	1,2	4	43	DIN	ZKG1322	015
Punto 60 1.2	176 B1000, 176 B4000	03.94 - 09.99	1,2	4	44	DIN	ZKG1322	015
Punto 60 1.2	188 A4000	09.99 ->	1,2	4	44	DIN	ZKG1322	015
Punto 60 1.2 Cabriolet	176 A7000	04.94 - 06.00	1,2	4	43	DIN	ZKG1322	015
Punto 60 1.2 Cabriolet	176 B1000, 176 B4000	05.95 - 06.00	1,2	4	44	DIN	ZKG1322	015
Punto 60 1.2 Van	188 A4000	02.00 ->	1,2	4	44	DIN	ZKG1322	015
Punto 75 1.2	176 A8000	10.93 - 09.99	1,2	4	54	DIN	ZKG1322	015
Punto Evo 1.2	199 A4000	10.09 ->	1,2	4	48	M4	ZKG1326	016
Punto Evo 1.4	350 A1000	10.09 ->	1,4	4	77	M4	ZKG1326	016
Seicento 1.1	176 B2000, 187 A1000	01.98 ->	1,1	4	40	DIN	ZKG1322	015
Strada 1.2	178 B5000	06.99 ->	1,2	4	54	DIN	ZKG1322	015
Ulysee 2.0 Turbo	RGX (XU10J2CTE)	06.94 - 08.02	2,0	4	108	M4	ZKG1550	019
Ulysse 1.8	LFW	05.97 - 08.02	1,8	4	73	M4	ZKG1550	019
Ulysse 2.0	RFU (XU10J2C)	06.94 - 08.02	2,0	4	89	M4	ZKG1550	019

## Ford

B-Max 1.4	---	10.12 ->	1,4	4	66	M4	ZKG1899	023
B-Max 1.6 Ti	IQDA	10.12 ->	1,6	4	77	M4	ZKG1899	023
C-Max I 1.6	SHDA, SHDB	02.07 ->	1,6	4	74	M4	ZKG1899	023
C-Max II 1.6	IQDA, IQDB	12.10 ->	1,6	4	66	M4	ZKG1899	023
C-Max II 1.6 Flexifuel	MUDA	02.11 ->	1,6	4	88	M4	ZKG1899	023
C-Max II 1.6 LPG	---	02.12 ->	1,6	4	88	M4	ZKG1899	023
Cougar 2.0 16V	EDBA, EDBB, EDBC, EDBD	08.98 - 12.01	2,0	4	96	M4	ZKG1890	023
Ecosport 1.5	---	10.13 ->	1,5	4	82	M4	ZKG1899	023
Fiesta V 1.25 16V	FUJA, FUJB	05.02 ->	1,3	4	55	M4	ZKG1899	023
Fiesta V 1.25 16V	M7JA, M7JB	03.03 ->	1,3	4	51	M4	ZKG1899	023
Fiesta V 1.3	A9JA, A9JB	11.01 ->	1,3	4	51	M4	ZKG1898	024

Typ Type	Motornummer Engine-No.	Baujahr Year	Liter Litre	Zyl. Cyl.	KW	Vert. Distr.	BBT-Nr. BBT-No.	Abb. Pict.
Fiesta V 1.3	BAJA	11.01 ->	1,3	4	44	M4	ZKG1898	024
Fiesta V 1.4 16V	FXJA, FXJB	11.01 ->	1,4	4	59	M4	ZKG1899	023
Fiesta V 1.6 16V	FYJA	11.01 ->	1,6	4	74	M4	ZKG1899	023
Fiesta Van 1.25	SNJA, SNJB	01.09 ->	1,2	4	60	M4	ZKG1899	023
Fiesta VI 1.25	SNJA, SNJB	10.08 ->	1,2	4	60	M4	ZKG1899	023
Fiesta Vi 1.25	STJA, STJB	10.08 ->	1,2	4	44	M4	ZKG1899	023
Fiesta VI 1.4	SPJA, SPJC	10.08 ->	1,4	4	71	M4	ZKG1899	023
Fiesta VI 1.4 LPG	RTJA, RTJB	01.09 ->	1,4	4	71	M4	ZKG1899	023
Fiesta VI 1.6 Ti	HXJA, HXJB	10.08 ->	1,6	4	88	M4	ZKG1899	023
Fiesta VI 1.6 Ti	IQDA	09.12 ->	1,6	4	77	M4	ZKG1899	023
Fiesta VI 1.6 Ti	U5JA	12.10 ->	1,6	4	99	M4	ZKG1899	023
Focus 1.8 16V	EYDB, EYDC, EYDD, EYDE, EYDF	10.98 - 11.04	1,8	4	85	M4	ZKG1890	023
Focus 2.0 16V	EDDB, EDDC, EDDD, EDDF	10.98 - 11.04	2,0	4	96	M4	ZKG1890	023
Focus 2.0 RS	HMDA	10.02 - 11.04	2,0	4	158	M4	ZKG1890	023
Focus 2.0 ST170	ALDA	03.02 - 11.04	2,0	4	127	M4	ZKG1890	023
Focus C-Max 1.6	HWDA, HWDB	10.03 - 03.07	1,6	4	74	M4	ZKG1890	023
Focus C-Max 1.6	HXJA, HXJB	10.03 - 03.07	1,6	4	74	M4	ZKG1899	023
Focus C-Max 1.6 Ti	HXDA, SIDA	08.04 - 03.07	1,6	4	85	M4	ZKG1899	023
Focus II 1.4	ASDA, ASDB	11.04 ->	1,4	4	59	M4	ZKG1890	023
Focus II 1.4	ASDA, ASDB	04.05 ->	1,4	4	59	M4	ZKG1890	023
Focus II 1.6	HWDA, HWDB, SHDA	11.04 ->	1,6	4	74	M4	ZKG1890	023
Focus II 1.6	HWDA, HWDB, SHDA	04.05 ->	1,6	4	74	M4	ZKG1890	023
Focus II 1.6 LPG	SIDA	10.09 ->	1,6	4	85	M4	ZKG1899	023
Focus II 1.6 Ti	HWDA, HWDB	04.05 ->	1,6	4	85	M4	ZKG1890	023
Focus II 1.6 Ti	HXDA, HXDB	11.04 ->	1,6	4	85	M4	ZKG1890	023
Focus II Cabriolet 1.6	HWDA, HWDB	10.06 ->	1,6	4	74	M4	ZKG1890	023
Focus III 1.6	---	04.11 ->	1,6	4	77	M4	ZKG1899	023
Focus III 1.6	PNDA	04.11 ->	1,6	4	92	M4	ZKG1899	023
Focus III 1.6 Flexifuel	---	04.11 ->	1,6	4	88	M4	ZKG1899	023
Focus III 1.6 LPG	MUDA	02.12 ->	1,6	4	88	M4	ZKG1899	023
Focus III 1.6 Ti	---	04.11 ->	1,6	4	77	M4	ZKG1899	023
Focus III 1.6 Ti	PNDA	04.11 ->	1,6	4	92	M4	ZKG1899	023
Fusion 1.25	FUJA, FUJB	08.04 ->	1,3	4	55	M4	ZKG1899	023
Fusion 1.4	FXJA, FXJB	08.02 ->	1,4	4	59	M4	ZKG1899	023
Fusion 1.6	FYJA	08.02 ->	1,6	4	74	M4	ZKG1899	023
Grand C-Max 1.6	IQDA, IQDB	12.10 ->	1,6	4	77	M4	ZKG1899	023
Grand C-Max 1.6	PNDA	12.10 ->	1,6	4	92	M4	ZKG1899	023
KA 1.3i	A9A, A9B	08.02 - 11.08	1,3	4	51	M4	ZKG1898	024
KA 1.3i	BAA, J4D, J4K, J4M, J4N, J4P	09.96 - 11.08	1,3	4	44	M4	ZKG1898	024
KA 1.6i	CDB, CDC	07.03 - 11.08	1,6	4	70	M4	ZKG1898	024
Maverick 2.0 16V	YF	02.01 ->	2,0	4	91	M4	ZKG1890	023
Mondeo IV 1.6 Ti	---	03.07 ->	1,6	4	81	M4	ZKG1899	023
Mondeo IV 1.6 Ti	PNBA	07.10 ->	1,6	4	88	M4	ZKG1899	023
Mondeo IV 1.6 Ti	RHBA	03.07 ->	1,6	4	92	M4	ZKG1899	023
Street KA 1.6	CDRA, CDRB	05.03 - 07.05	1,6	4	70	M4	ZKG1898	024
<b>Hyundai</b>								
Accent I 1.3	G4EH	10.94 - 01.00	1,3	4	55	DIN	ZKG1752	013
Accent I 1.3i 12V	G4EH	10.94 - 01.00	1,3	4	62	DIN	ZKG1752	013
Accent I 1.5i 12V	G4EK	10.94 - 01.00	1,5	4	65	DIN	ZKG1752	013
Accent I 1.5i 16V	G4ER	12.95 - 01.00	1,5	4	73	DIN	ZKG1752	013
Accent II 1.3	G4E-A	01.00 - 11.05	1,3	4	55	DIN	ZKG1752	013
Atos 1.0i	G4HC-E	03.01 ->	1,0	4	43	DIN	ZKG1752	013
Atos Prime 1.0	G4HC-E	03.01 ->	1,0	4	43	DIN	ZKG1752	013
Coupe 1.6i 16V	4G61	12.96 - 04.02	1,6	4	84	DIN	ZKG1749	030
Coupe 1.6i 16V	G4GR	03.98 - 04.02	1,6	4	85	DIN	ZKG1749	030
Coupe 2.0 16V	---	03.01 - 04.02	2,0	4	99	DIN	ZKG1749	030
Coupe 2.0 16V	G4GF	08.96 - 04.02	2,0	4	102	DIN	ZKG1749	030
Elantra 1.8	G4BB	06.00 ->	1,8	4	97	DIN	ZKG1749	030

Typ Type	Motornummer Engine-No.	Baujahr Year	Liter Litre	Zyl. Cyl.	KW	Vert. Distr.	BBT-Nr. BBT-No.	Abb. Pict.
Elantra 2.0	G4GC	10.03 ->	2,0	4	105	DIN	ZKG1749	030
Elantra 2.0	G4GC	06.00 ->	2,0	4	104	DIN	ZKG1749	030
Elantra 2.0	G4GC-G	06.00 ->	2,0	4	102	DIN	ZKG1749	030
i10 1.1	---	04.11 ->	1,1	4	51	DIN	ZKG1752	013
i10 1.1	G4HG	01.08 ->	1,1	4	49	DIN	ZKG1752	013
i10 1.2	G4LA	11.08 ->	1,2	4	57	DIN	ZKG1715	031
i10 1.2	G4LA	04.11 ->	1,2	4	63	DIN	ZKG1715	031
i20 1.2	G4LA	09.08 ->	1,2	4	57	DIN	ZKG1715	031
i20 1.2	G4LA	03.12 ->	1,2	4	63	DIN	ZKG1715	031
i30 2.0	G4GC-G	10.07 ->	2,0	4	105	DIN	ZKG1749	030
i30 CW 2.0	G4GC-G	02.08 ->	2,0	4	105	DIN	ZKG1749	030
Lantra II 1.6 16V	4G61	11.95 - 09.00	1,6	4	84	DIN	ZKG1749	030
Lantra II 1.6i	G4GR	11.95 - 09.00	1,6	4	66	DIN	ZKG1749	030
Lantra II 1.8 16V	G4GM	11.95 - 09.00	1,8	4	94	DIN	ZKG1749	030
Lantra II 2.0 16V	G4GF	08.96 - 09.00	2,0	4	102	DIN	ZKG1749	030
Matrix 1.8	G4GB-G	06.01 ->	1,8	4	90	DIN	ZKG1749	030
Trajet 2.0	G4GC-G	01.04 ->	2,0	4	103	DIN	ZKG1749	030
Trajet 2.0	G4JP-G	03.00 ->	2,0	4	100	DIN	ZKG1749	030
Tucson 2.0	G4GC	08.04 ->	2,0	4	104	DIN	ZKG1749	030

### Kia

Carens II 2.0 CVVT	G4GC	08.04 ->	2,0	4	102	DIN	ZKG1749	030
Cee'd 2.0	G4GC	12.06 ->	2,0	4	105	DIN	ZKG1749	030
Cerato 2.0	G4GC	04.04 ->	2,0	4	105	DIN	ZKG1749	030
Picanto 1.0	G4HE	11.09 ->	1,0	4	46	DIN	ZKG1752	013
Picanto 1.2	G4LA	09.11 ->	1,2	4	63	DIN	ZKG1715	031
Pro Cee'd 2.0	G4GC	02.08 ->	2,0	4	105	DIN	ZKG1749	030
Rio III 1.25 CVVT	G4LA	09.11 ->	1,25	4	63	DIN	ZKG1715	031
Rio III 1.25 CVVT	G4LA	09.11 ->	1,25	4	65	DIN	ZKG1715	031
Rio III 1.25 LPG	---	09.11 ->	1,25	4	63	DIN	ZKG1715	031
Sportage 2.0i 16V	G4GC	09.04 ->	2,0	4	104	DIN	ZKG1749	030

### Mazda

2 1.25	FUJA	04.03 ->	1,3	4	55	M4	ZKG1899	023
2 1.4	FXJA	04.03 ->	1,4	4	59	M4	ZKG1899	023
2 1.6	FYJA	04.03 ->	1,6	4	74	M4	ZKG1899	023
6 1.8	L813	08.02 ->	1,8	4	88	M4	ZKG1729	023
6 2.0	LF17	08.02 ->	2,0	4	104	M4	ZKG1729	023

### MCC (Micro Compact Car)

Smart Cabrio 0.6	---	06.02 - 01.04	0,6	3	52	M4	ZKG0441	026
Smart Cabrio 0.6	M160 E6AL B03	03.00 - 01.04	0,6	3	40	M4	ZKG0441	026
Smart Cabrio 0.6	M160 E6AL B05	01.01 - 01.04	0,6	3	45	M4	ZKG0441	026
Smart Cabrio 0.7	---	01.03 - 01.04	0,7	3	45	M4	ZKG0441	026
Smart City-Coupe 0.6	M160 E6AL B04	07.98 - 01.04	0,6	3	33	M4	ZKG0441	026
Smart City-Coupe 0.7	---	01.03 - 01.04	0,7	3	37	M4	ZKG0441	026
Smart Fortwo Coupe 1.0	M132.910	01.07 ->	1,0	3	45	M4	ZKG0441	026
Smart Fortwo Coupe 1.0 Brabus	M132.930	01.08 ->	1,0	3	72	M4	ZKG0441	026
Smart Fortwo Coupe 1.0 Turbo	M132.930	01.07 ->	1,0	3	62	M4	ZKG0441	026

### Mercedes Benz

190 2.0 (W201)	M102.921	10.82 - 10.84	2,0	4	66	SAE	ZKG0415	004
190 2.0 (W201)	M102.924	01.86 - 05.90	2,0	4	75	SAE	ZKG0415	004
190 2.0 (W201)	M102.924	09.84 - 05.90	2,0	4	77	SAE	ZKG0415	004
190 E 1.8 (W201)	M102.910	04.90 - 08.93	1,8	4	80	SAE	ZKG0415	004
190 E 2.0 (W201)	M102.961, M102.962	02.85 - 12.86	2,0	4	83	SAE	ZKG0415	004
190 E 2.0 (W201)	M102.961, M102.962	10.82 - 06.93	2,0	4	90	SAE	ZKG0415	004
190 E 2.3 (W201)	M102.985	09.86 - 08.91	2,3	4	97	SAE	ZKG0415	004
190 E 2.3 (W201)	M102.985	10.86 - 08.93	2,3	4	100	SAE	ZKG0415	004

Typ Type	Motornummer Engine-No.	Baujahr Year	Liter Litre	Zyl. Cyl.	KW	Vert. Distr.	BBT-Nr. BBT-No.	Abb. Pict.
200 (W123)	M102.920	06.80 - 11.85	2,0	4	80	SAE	ZKG0415	004
200 (W123)	M102.939	06.80 - 11.85	2,0	4	74	SAE	ZKG0415	004
200 (W124)	M102.922	01.86 - 05.90	2,0	4	77	SAE	ZKG0415	004
200 (W124)	M102.922	12.85 - 05.90	2,0	4	75	SAE	ZKG0415	004
200 E (W124)	M102.963	09.88 - 08.92	2,0	4	87	SAE	ZKG0415	004
200 E (W124)	M102.982	01.85 - 06.93	2,0	4	100	SAE	ZKG0415	004
200 E (W124)	M111.960	10.92 - 06.93	2,0	4	110	SAE	ZKG0415	004
200 T (S123)	M102.920	11.80 - 11.85	2,0	4	80	SAE	ZKG0415	004
200 T (S124)	M102.922	01.86 - 05.90	2,0	4	77	SAE	ZKG0415	004
220 CE (C124)	M111.960	10.92 - 05.93	2,2	4	110	SAE	ZKG0415	004
230 CE (C123)	M102.980	04.80 - 12.85	2,3	4	100	SAE	ZKG0415	004
230 CE (C124)	M102.982	03.87 - 12.92	2,3	4	100	SAE	ZKG0415	004
230 CE (C124) Kat.	M102.982	06.89 - 12.92	2,3	4	97	SAE	ZKG0415	004
230 E (W123)	M102.980	04.80 - 12.85	2,3	4	100	SAE	ZKG0415	004
230 E (W124)	M102.982	12.84 - 03.92	2,3	4	97	SAE	ZKG0415	004
230 E (W124) Kat.	M102.982	06.89 - 06.93	2,3	4	97	SAE	ZKG0415	004
230 GE (W460)	M102.979, M102.987	05.87 - 08.92	2,3	4	92	SAE	ZKG0415	004
230 GE (W460)	M102.981, M102.987	04.82 - 08.92	2,3	4	92	SAE	ZKG0415	004
230 GE (W461)	M102.979	02.93 ->	2,3	4	90	SAE	ZKG0415	004
230 GE (W461)	M102.996, M102.997	06.93 ->	2,3	4	92	SAE	ZKG0415	004
230 GE (W463)	M102.989	06.90 - 06.93	2,3	4	93	SAE	ZKG0415	004
230 TE (S123)	M102.980	04.80 - 11.85	2,3	4	100	SAE	ZKG0415	004
230 TE (S124) Kat.	M102.982	06.89 - 08.92	2,3	4	97	SAE	ZKG0415	004
A 150 (W169)	M266.920	09.04 ->	1,5	4	70	M4	ZKG0452	005
A 160 (W169)	M266.920	04.09 ->	1,5	4	70	M4	ZKG0452	005
A 170 (W169)	M266.940	09.04 ->	1,7	4	85	M4	ZKG0452	005
A 180 (W169)	M266.940	04.09 ->	1,7	4	85	M4	ZKG0452	005
A 200 (W169)	M266.960	09.04 ->	2,0	4	100	M4	ZKG0452	005
A 200 (W169)	M266.980	09.05 ->	2,0	4	142	M4	ZKG0452	005
B 150 (W245)	M266.920	03.05 ->	1,5	4	70	M4	ZKG0452	005
B 160 (W245)	M266.920	04.09 ->	1,5	4	70	M4	ZKG0452	005
B 170 (W245)	M266.940	03.05 ->	1,7	4	85	M4	ZKG0452	005
B 180 (W245)	M266.940	04.09 ->	1,7	4	85	M4	ZKG0452	005
B 200 (W245)	M266.960	03.05 ->	2,0	4	100	M4	ZKG0452	005
B 200 Turbo (W245)	M266.980	03.05 ->	2,0	4	142	M4	ZKG0452	005
C 230 (W203)	M272.920	01.05 - 05.06	2,5	6	150	M4	ZKG0487	032
C 230 Sportcoupe (CL203)	M272.920	01.05 - 05.06	3,5	6	150	M4	ZKG0487	032
C 240 (W202)	M112.910	06.97 - 05.00	2,4	6	125	M4	ZKG0437	005
C 240 (W203)	M112.912	05.00 - 02.07	2,4	6	125	M4	ZKG0437	005
C 240 4-matic (W203)	M112.916	07.02 - 02.07	2,4	6	125	M4	ZKG0437	005
C 240 T (S202)	M112.910	06.97 - 05.00	2,4	6	125	M4	ZKG0437	005
C 280 (W202)	M112.920	06.97 - 05.00	2,8	6	145	M4	ZKG0437	005
C 280 (W203)	M272.940	01.05 - 05.06	3,0	6	170	M4	ZKG0487	032
C 280 T (S202)	M112.920	06.97 - 03.01	2,8	6	145	M4	ZKG0437	005
C 32 AMG Kompressor (W203)	M112.961	02.01 - 02.07	3,2	6	260	M4	ZKG0437	005
C 320 (W203)	M112.946	05.00 - 08.07	3,2	6	160	M4	ZKG0437	005
C 320 4-matic (W203)	M112.953	07.02 - 08.07	3,2	6	160	M4	ZKG0437	005
C 320 Sportcoupe (CL203)	M112.946	09.02 - 05.08	3,2	6	160	M4	ZKG0437	005
C 350 (W203)	M272.960	01.05 - 05.06	3,5	6	200	M4	ZKG0487	032
C 350 CGI (W204)	M272.982	09.08 ->	3,5	6	215	M4	ZKG0487	032
C 350 Sportcoupe (CL203)	M272.960	01.05 - 06.11	3,5	6	200	M4	ZKG0487	032
CL 500 (C215)	M113.960	03.99 - 03.06	5,0	8	225	M4	ZKG0440	005
CLC 230 (CL203)	M272.920	05.08 - 06.11	2,5	6	150	M4	ZKG0487	032
CLC 350 (CL203)	M272.960	05.08 - 06.11	3,5	6	200	M4	ZKG0487	032
CLK 240 (C209)	M112.912	06.02 - 05.09	2,4	6	125	M4	ZKG0437	005
CLK 280 (C209)	M272.940	01.05 - 05.06	3,0	6	170	M4	ZKG0487	032
CLK 320 (C208)	M112.940	06.97 - 06.02	3,2	6	160	M4	ZKG0437	005
CLK 320 (C208)	M112.955	06.02 - 05.09	3,2	6	160	M4	ZKG0437	005
CLK 350 (C209)	M272.940	01.05 - 05.06	3,5	6	200	M4	ZKG0487	032

Typ Type	Motornummer Engine-No.	Baujahr Year	Liter Litre	Zyl. Cyl.	KW	Vert. Distr.	BBT-Nr. BBT-No.	Abb. Pict.
CLK 430 (C208)	M113.943	07.98 - 06.02	4,3	8	205	M4	ZKG0440	005
CLK 500 (C209)	M113.968	06.02 ->	5,0	8	225	M4	ZKG0440	005
CLK 55 AMG (C208)	M113.981, M113.984	08.99 - 06.02	5,5	8	255	M4	ZKG0440	005
CLS 280 (C219)	M272.943	07.08 - 12.10	3,0	6	170	M4	ZKG0487	032
CLS 300 (C219)	M272.943	04.09 - 12.10	3,0	6	170	M4	ZKG0487	032
CLS 350 (C219)	---	04.06 - 12.10	3,5	6	215	M4	ZKG0487	032
CLS 350 (C219)	M272.964	10.04 - 05.06	3,5	6	200	M4	ZKG0487	032
CLS 350 CGI (C219)	M272.985	04.09 - 12.10	3,5	6	215	M4	ZKG0487	032
E 200 Kompressor (W210)	M111.947	06.97 - 03.02	2,0	4	137	M4	ZKG0444	006
E 200 T Kompressor (S210)	M111.947	06.97 - 03.03	2,0	4	137	M4	ZKG0444	006
E 230 (W210)	M111.970	06.95 - 06.97	2,3	4	110	M4	ZKG0444	006
E 230 (W211)	M272.922	09.07 - 12.08	2,5	6	150	M4	ZKG0487	032
E 240 (W210)	M112.911	06.97 - 08.00	2,4	6	125	M4	ZKG0437	005
E 240 (W210)	M112.914	08.00 - 03.02	2,4	6	125	M4	ZKG0437	005
E 240 (W211)	M112.913, M112.917	03.02 - 12.08	2,4	6	130	M4	ZKG0437	005
E 240 4-matic (W211)	M112.917	03.03 - 12.08	2,4	6	130	M4	ZKG0437	005
E 280 (W210)	M112.921	12.96 - 03.02	2,8	6	150	M4	ZKG0437	005
E 280 (W211)	M272.943	03.05 - 05.06	3,0	6	170	M4	ZKG0487	032
E 280 4-matic (W210)	M112.921	12.96 - 03.02	2,8	6	150	M4	ZKG0437	005
E 320 (W210)	M112.941	06.97 - 03.02	3,2	6	165	M4	ZKG0437	005
E 320 (W211)	M112.949	03.02 - 12.08	3,2	6	165	M4	ZKG0437	005
E 350 (W211)	M272.964	03.05 - 05.06	3,5	6	200	M4	ZKG0487	032
E 350 CGI (A207)	M272.982, M272.984	01.10 ->	3,5	6	215	M4	ZKG0487	032
E 350 CGI (W211)	M272.977	01.09 - 08.11	3,5	6	215	M4	ZKG0487	032
E 350 CGI (W211)	M272.985	09.07 - 12.08	3,5	6	215	M4	ZKG0487	032
E 430 (W210)	M113.940	06.97 - 03.02	4,3	8	205	M4	ZKG0440	005
E 500 (W211)	M113.967	03.02 ->	5,0	8	225	M4	ZKG0440	005
E 55 AMG Kompressor (W211)	M113.990	10.02 ->	5,5	8	350	M4	ZKG0440	005
G 500 (W463)	M113.962	04.98 ->	5,0	8	218	M4	ZKG0440	005
ML 230 (W163)	M111.977	02.98 - 06.05	2,3	4	110	M4	ZKG0444	006
ML 430 (W163)	M113.942	02.98 - 06.05	4,3	8	200	M4	ZKG0440	005
ML 500 (W163)	M113.964, M113.965	09.01 - 06.05	5,0	8	215	M4	ZKG0440	005
ML 55 AMG (W163)	M113.981	02.00 - 06.05	5,5	8	255	M4	ZKG0440	005
S 430 (W220)	M113.941	10.98 - 08.05	4,3	8	205	M4	ZKG0440	005
S 500 (W220)	M113.960	10.98 - 08.05	5,0	8	225	M4	ZKG0440	005
SL 280 (R129)	M112.923, M112.925	05.98 - 10.01	2,8	6	150	M4	ZKG0437	005
SL 320 (R129)	M112.943	05.98 - 10.01	3,2	6	165	M4	ZKG0437	005
SL 350 (R230)	M112.973	03.03 - 01.12	3,5	6	180	M4	ZKG0437	005
SL 500 (R129)	M113.961	05.98 - 10.01	5,0	8	225	M4	ZKG0440	005
SL 500 (R230)	M113.963	10.01 ->	5,0	8	225	M4	ZKG0440	005
SLK 200 Kompressor (R170)	M111.958	03.00 - 04.04	2,0	4	120	M4	ZKG0444	006
SLK 32 AMG Kompressor (R170)	M112.960	03.01 - 04.04	3,2	6	260	M4	ZKG0437	005
SLK 320 (R170)	M112.947	03.00 - 04.04	3,2	6	260	M4	ZKG0437	005
Sprinter 2-t 214 NGT	M111.984	04.00 - 05.06	2,3	4	92	M4	ZKG0444	006
Sprinter 3-t 314 NGT	M111.984	04.00 - 05.06	2,3	4	92	M4	ZKG0444	006
<b>Mini</b>								
Cooper (R50, R53)	W10 B16 A	06.01 - 09.06	1,6	4	85	SAE	ZKG1248	012
Cooper (R56)	N12 B16 A	10.06 ->	1,6	4	88	SAE	ZKG1248	012
Cooper (R56)	N16 B16 A	03.10 ->	1,6	4	90	SAE	ZKG1248	012
Cooper Cabriolet (R52)	W10 B16 A	07.04 - 11.07	1,6	4	85	SAE	ZKG1248	012
Cooper S (R50, R53)	W11 B16 A	03.02 - 09.06	1,6	4	120	SAE	ZKG1248	012
Cooper S (R50, R53)	W11 B16 A	07.04 - 09.06	1,6	4	125	SAE	ZKG1248	012
Cooper S (R56)	N14 B16 A	10.06 ->	1,6	4	128	SAE	ZKG1248	012
Cooper S (R56)	N18 B16 A	03.10 ->	1,6	4	135	SAE	ZKG1248	012
Cooper S Cabriolet (R50, R53)	W11 B16 A	07.04 - 11.07	1,6	4	125	SAE	ZKG1248	012
John Cooper Works (R50, R53)	W11 B16 A	03.06 - 09.06	1,6	4	160	SAE	ZKG1248	012
John Cooper Works (R56)	N14 B16 C	03.08 ->	1,6	4	155	SAE	ZKG1248	012
John Cooper Works Cabriolet (R52)	W11 B16 A	07.04 - 11.07	1,6	4	155	SAE	ZKG1248	012

Typ Type	Motornummer Engine-No.	Baujahr Year	Liter Litre	Zyl. Cyl.	KW	Vert. Distr.	BBT-Nr. BBT-No.	Abb. Pict.
One (R50, R53)	W10 B16 A	06.01 - 09.06	1,6	4	66	SAE	ZKG1248	012
One (R56)	N12 B14 A	03.09 ->	1,4	4	55	SAE	ZKG1248	012
One (R56)	N12 B14 A	03.07 ->	1,4	4	70	SAE	ZKG1248	012
One (R56)	N16 B16 A	03.10 ->	1,6	4	55	SAE	ZKG1248	012
One (R56)	N16 B16 A	03.10 ->	1,6	4	72	SAE	ZKG1248	012
One Cabriolet (R52)	W10 B16 A	07.04 - 11.07	1,6	4	66	SAE	ZKG1248	012
Works (R50, R53)	W11 B16 A	11.03 - 09.06	1,6	4	155	SAE	ZKG1248	012

## Peugeot

106 I 1.0	CDY (TU9M)	09.91 - 04.96	1,0	4	33	M4	ZKG1555	020
106 I 1.1	HDZ (TU1M)	09.91 - 04.96	1,1	4	44	M4	ZKG1555	020
106 I 1.3	TU2J2	10.93 - 04.96	1,3	4	72	M4	ZKG1555	020
106 I 1.4	KFZ (TU3J2/Z)	09.91 - 04.96	1,4	4	69	M4	ZKG1555	020
106 II 1.0i	CDZ ( TU9M)	01.97 ->	1,0	4	37	M4	ZKG1555	020
106 II 1.1i	HDY (TU1M)	01.97 ->	1,1	4	40	M4	ZKG1555	020
106 II 1.1i	HDZ (TU1M), HFX (TU1JP)	05.96 ->	1,1	4	44	M4	ZKG1555	020
106 II 1.4i	KFW (TU3JP), KFX (TU3JP)	05.96 ->	1,4	4	55	M4	ZKG1555	020
106 II 1.6i	NFW (TU5J2)	05.96 ->	1,6	4	74	M4	ZKG1555	020
106 II 1.6i	NFZ (TU5JP)	05.96 ->	1,6	4	65	M4	ZKG1555	020
205 I 1.6 CJ Cabriolet	BDY (XU5M3Z)	08.92 - 12.94	1,6	4	65	M4	ZKG1549	018
205 I 1.9 CTI Cabriolet	DFZ (XU9J1)	10.87 - 12.94	1,9	4	75	M4	ZKG1549	018
205 II 1.6 Aut.	BDY (XU5M2Z), BDY (XU5M3Z)	05.90 - 09.98	1,6	4	65	M4	ZKG1549	018
205 II 1.9 GTI Kat.	DFZ (XU9J1)	10.87 - 12.94	1,9	4	75	M4	ZKG1549	018
306 1.1	HDZ (TU1M)	07.96 - 05.01	1,1	4	44	M4	ZKG1555	020
306 1.4	KDX (TU3MC), KFW (TU3JP)	05.93 - 05.01	1,4	4	55	M4	ZKG1555	020
306 1.4 SL	KDX (TU3MC), KFW (TU3JP)	06.94 - 05.01	1,4	4	55	M4	ZKG1555	020
306 1.6 Break	NFZ (TU5JP)	03.97 - 10.00	1,6	4	65	M4	ZKG1555	020
306 1.6 SR	NFZ (TU5JP)	06.94 - 10.00	1,6	4	65	M4	ZKG1555	020
306 1.8 16V	LFY (XU7JP4)	03.97 - 05.01	1,8	4	81	M4	ZKG1549	018
306 1.8 16V Break	LFY (XU7JP4)	03.97 - 04.02	1,8	4	81	M4	ZKG1549	018
306 1.8 16V Cabriolet	LFY (XU7JP4)	07.00 - 04.02	1,8	4	81	M4	ZKG1549	018
306 1.8 Break	LFZ (XU7JP)	03.97 - 04.02	1,8	4	74	M4	ZKG1549	018
306 1.8 Cabriolet	LFZ (XU7JP)	03.94 - 04.02	1,8	4	74	M4	ZKG1549	018
306 1.8 ST	LFZ (XU7JP)	06.94 - 05.01	1,8	4	74	M4	ZKG1549	018
306 2.0	RFV (XU10J4R)	03.97 - 05.01	2,0	4	97	M4	ZKG1550	019
306 2.0 16V Cabriolet	RFV (XU10J4R)	03.97 - 04.02	2,0	4	97	M4	ZKG1550	019
306 2.0 ST	RFX (XU10J2)	07.94 - 05.01	2,0	4	89	M4	ZKG1550	019
309 II 1.4	KDY (TU3M), KDX (TU3M)	07.89 - 12.93	1,4	4	55	M4	ZKG1555	020
309 II 1.6	BDY (XU5M2Z), BDY (XU5M3Z)	07.89 - 12.93	1,6	4	65	M4	ZKG1549	018
405 II 1.6 (Ch. 70119981->)	BDY (XU5M2Z), BDY (XU5M3Z)	08.92 - 10.95	1,6	4	65	M4	ZKG1549	018
405 II 1.8	LFZ (XU7JP)	08.92 - 10.95	1,8	4	74	M4	ZKG1549	018
405 II 1.8 Break	LFZ (XU7JP)	08.92 - 10.96	1,8	4	74	M4	ZKG1549	018
405 II 2.0	RFX (XU10J2)	08.92 - 10.95	2,0	4	89	M4	ZKG1550	019
406 1.6	BFZ (XU5JP)	11.95 - 05.04	1,6	4	65	M4	ZKG1549	018
406 1.8	LFX (XU7JB)	05.97 - 05.04	1,8	4	66	M4	ZKG1549	018
406 1.8 16V	LFY (XU7JP4)	11.95 - 10.00	1,8	4	81	M4	ZKG1549	018
406 2.0 16V	RFV (XU10J4R)	11.95 - 05.04	2,0	4	97	M4	ZKG1550	019
406 2.0 16V Coupe	RFV (XU10J4R)	03.97 - 12.04	2,0	4	97	M4	ZKG1550	019
406 2.0 Turbo	RGX (XU10J2TE)	04.96 - 05.04	2,0	4	108	M4	ZKG1550	019
605 2.0 Turbo	RGX (XU10J2TE)	07.92 - 09.99	2,0	4	104	M4	ZKG1550	019
605 2.0 Turbo	RGX (XU10J2TE)	07.91 - 09.99	2,0	4	108	M4	ZKG1550	019
806 2.0	RFU (XU10J2)	06.94 - 08.02	2,0	4	89	M4	ZKG1550	019
806 2.0 16V	RFV (XU10J4R)	05.98 - 09.00	2,0	4	97	M4	ZKG1550	019
806 2.0 Turbo	RGX (XU10J2TE)	06.94 - 08.02	2,0	4	108	M4	ZKG1550	019
Boxer 2.0i	RFX (XU10J2)	03.94 - 04.02	2,0	4	80	M4	ZKG1549	018
Partner 1.4	KFX (TU3JP), TU32	06.96 ->	1,4	4	55	M4	ZKG1555	020
Partner Combispace 1.1	HDZ (TU1M), HFX (TU1JP)	06.96 ->	1,1	4	44	M4	ZKG1555	020
Partner Combispace 1.8	LFX (XU7JB)	05.97 ->	1,8	4	66	M4	ZKG1549	018

Typ Type	Motornummer Engine-No.	Baujahr Year	Liter Litre	Zyl. Cyl.	KW	Vert. Distr.	BBT-Nr. BBT-No.	Abb. Pict.
-------------	---------------------------	-----------------	----------------	--------------	----	-----------------	--------------------	---------------

### Renault

Clio Grandtour 1.2 16V	D4F 740	02.08 ->	1,2	4	55	M4	ZKG1571	021
Clio Grandtour 1.2 16V	D4F 764	02.08 ->	1,2	4	58	M4	ZKG1571	021
Clio Grandtour 1.2 16V	D4F 784	02.08 ->	1,2	4	74	M4	ZKG15112	022
Clio Grandtour 1.2 16V	D4F 784	02.08 ->	1,2	4	74	M4	ZKG1571	021
Clio Grandtour 1.2 16V	D4F 786	09.10 ->	1,2	4	76	M4	ZKG15112	022
Clio Grandtour 1.2 16V Hi-Flex	D4F 740	07.08 ->	1,2	4	55	M4	ZKG1571	021
Clio Grandtour IV 1.2 16V	D4F 740	01.13 ->	1,2	4	54	M4	ZKG1571	021
Clio III 1.2 16V	D4F 740	06.05 ->	1,2	4	55	M4	ZKG1571	021
Clio III 1.2 16V	D4F 740	06.05 ->	1,2	4	48	M4	ZKG1571	021
Clio III 1.2 16V	D4F 764	06.05 ->	1,2	4	58	M4	ZKG1571	021
Clio III 1.2 16V	D4F 784	05.07 ->	1,2	4	74	M4	ZKG1571	021
Clio III 1.2 16V	D4F 786	09.10 ->	1,2	4	76	M4	ZKG15112	022
Clio III 1.2 16V Hi-Flex	D4F 740	07.08 ->	1,2	4	55	M4	ZKG1571	021
Kangoo 1.2 16V	D4F 712, D4F 714, D4F 716	06.01 ->	1,2	4	55	M4	ZKG1571	021
Kangoo 1.6	K7M 750	02.08 ->	1,6	4	64	M4	ZKG15112	022
Kangoo Rapid 1.2 16V	D4F 712, D4F 714	10.01 ->	1,2	4	55	M4	ZKG1571	021
Logan 1.4	K7J 710	09.04 ->	1,4	4	55	M4	ZKG15112	022
Logan 1.4	K7J 710	10.07 ->	1,4	4	55	M4	ZKG15112	022
Logan 1.6	K7M 710	09.04 ->	1,6	4	64	M4	ZKG15112	022
Logan 1.6	K7M 710	04.07 ->	1,6	4	64	M4	ZKG15112	022
Modus 1.2	D4F 740	12.04 ->	1,2	4	55	M4	ZKG1571	021
Modus 1.2	D4F 786	04.11 ->	1,2	4	76	M4	ZKG15112	022
Modus 1.2 16V	D4F 784	05.07 ->	1,2	4	74	M4	ZKG1594	021
Modus 1.2 16V Hi-Flex	D4F 740	10.08 ->	1,2	4	55	M4	ZKG1571	021
Sandero 1.4	K7J 710	02.09 ->	1,4	4	55	M4	ZKG15112	022
Twingo I 1.2 16V	D4F 702, D4F 704	01.01 ->	1,2	4	55	M4	ZKG1571	021
Twingo II 1.2 16V	D4F 772	03.07 ->	1,2	4	56	M4	ZKG1571	021
Twingo II 1.2 TCe 100	D4F 780	02.11 ->	1,2	4	75	M4	ZKG15112	022
Twingo II 1.2 Turbo	D4F 780	03.07 ->	1,2	4	74	M4	ZKG1594	021
Wind 1.2	D4F 782	07.10 ->	1,2	4	74	M4	ZKG15112	022
Wind 1.2 TCe 100	D4F 780	02.11 ->	1,2	4	75	M4	ZKG15112	022

### Seat

Alhambra 2.0 i	ADY	04.96 - 03.10	2,0	4	85	M4	ZKG3000	025
Altea 1.2 TSI	CBZB	04.10 ->	1,2	4	77	M4	ZKG0314	001
Altea 1.2 TSI	CBZB	04.10 ->	1,2	4	77	M4	ZKG0328	027
Altea XL 1.2 TSI	CBZB	04.10 ->	1,2	4	77	M4	ZKG0314	001
Altea XL 1.2 TSI	CBZB	04.10 ->	1,2	4	77	M4	ZKG0328	027
Exeo 1.6	ALZ	03.09 - 09.10	1,6	4	75	M4	ZKG3000	025
Exeo 1.8 T	CFMA	03.09 - 05.10	1,8	4	110	M4	ZKG3000	025
Exeo ST 1.6	ALZ	06.09 - 09.10	1,6	4	75	M4	ZKG3000	025
Exeo ST 1.8 T	CFMA	06.09 - 05.10	1,8	4	110	M4	ZKG3000	025
Ibiza V 1.2 TSI	CBZA	08.12 ->	1,2	4	63	M4	ZKG0314	001
Ibiza V 1.2 TSI	CBZA	08.12 ->	1,2	4	63	M4	ZKG0328	027
Ibiza V 1.2 TSI	CBZB	09.10 ->	1,2	4	77	M4	ZKG0314	001
Ibiza V 1.2 TSI	CBZB	09.10 ->	1,2	4	77	M4	ZKG0328	027
Ibiza V Sportcoupe 1.2 TSI	CBZA	08.12 ->	1,2	4	63	M4	ZKG0314	001
Ibiza V Sportcoupe 1.2 TSI	CBZA	08.12 ->	1,2	4	63	M4	ZKG0328	027
Ibiza V Sportcoupe 1.2 TSI	CBZA	08.12 ->	1,2	4	63	M4	ZKG0328	027
Ibiza V Sportcoupe 1.2 TSI	CBZB	09.10 ->	1,2	4	77	M4	ZKG0314	001
Ibiza V Sportcoupe 1.2 TSI	CBZB	09.10 ->	1,2	4	77	M4	ZKG0328	027
Ibiza V ST 1.2 TSI	CBZA	09.12 ->	1,2	4	63	M4	ZKG0314	001
Ibiza V ST 1.2 TSI	CBZA	09.12 ->	1,2	4	63	M4	ZKG0328	027
Ibiza V ST 1.2 TSI	CBZB	09.10 ->	1,2	4	77	M4	ZKG0314	001
Ibiza V ST 1.2 TSI	CBZB	09.10 ->	1,2	4	77	M4	ZKG0328	027
Leon 1.2 TSI	CBZB	02.10 ->	1,2	4	77	M4	ZKG0314	001
Leon 1.2 TSI	CBZB	02.10 ->	1,2	4	77	M4	ZKG0328	027
Leon 1.6	AEH, AKL	11.99 ->	1,6	4	74	M4	ZKG0359	003

Type	Motornummer Engine-No.	Baujahr Year	Liter Litre	Zyl. Cyl.	KW	Vert. Distr.	BBT-Nr. BBT-No.	Abb. Pict.
Leon 1.6	BSE, BSF, CCSA	07.05 ->	1,6	4	75	M4	ZKG3000	025
Leon 1.6 LPG	CHGA	12.09 ->	1,6	4	75	M4	ZKG3000	025
Toledo II 1.6	AEH, AKL	04.99 - 09.00	1,6	4	74	M4	ZKG0359	003
Toledo III 1.6	BGU, BSE, BSF, CCSA	10.04 - 05.09	1,6	4	75	M4	ZKG3000	025
Toledo IV 1.2 TSI	CBZA	07.12 ->	1,2	4	63	M4	ZKG0314	001
Toledo IV 1.2 TSI	CBZA	07.12 ->	1,2	4	63	M4	ZKG0328	027
Toledo IV 1.2 TSI	CBZB	07.12 ->	1,2	4	77	M4	ZKG0314	001
Toledo IV 1.2 TSI	CBZB	07.12 ->	1,2	4	77	M4	ZKG0328	027
<b>Skoda</b>								
Fabia 1.2 TSI	CBZA	03.10 ->	1,2	4	63	M4	ZKG0328	027
Fabia 1.2 TSI	CBZA	03.10 ->	1,2	4	63	M4	ZKG0314	001
Fabia 1.2 TSI	CBZB	03.10 ->	1,2	4	77	M4	ZKG0328	027
Fabia 1.2 TSI	CBZB	03.10 ->	1,2	4	77	M4	ZKG0314	001
Octavia 1.2 TSI	CBZB	02.10 ->	1,2	4	77	M4	ZKG0328	027
Octavia 1.2 TSI	CBZB	02.10 ->	1,2	4	77	M4	ZKG0314	001
Octavia 1.6	AEH, AKL	02.97 ->	1,6	4	74	M4	ZKG0359	003
Octavia 1.6	AVU, BFQ	11.00 - 12.10	1,6	4	75	M4	ZKG3000	025
Octavia 1.6	BGU, BSE, BSF, CCSA	06.04 ->	1,6	4	74	M4	ZKG3000	025
Rapid 1.2 TSI	CBZA	07.12 ->	1,2	4	63	M4	ZKG0328	027
Rapid 1.2 TSI	CBZA	07.12 ->	1,2	4	63	M4	ZKG0314	001
Rapid 1.2 TSI	CBZB	07.12 ->	1,2	4	77	M4	ZKG0328	027
Rapid 1.2 TSI	CBZB	07.12 ->	1,2	4	77	M4	ZKG0314	001
Roomster 1.2 TSI	CBZA	03.10 ->	1,2	4	63	M4	ZKG0328	027
Roomster 1.2 TSI	CBZA	03.10 ->	1,2	4	63	M4	ZKG0314	001
Roomster 1.2 TSI	CBZB	03.10 ->	1,2	4	77	M4	ZKG0328	027
Roomster 1.2 TSI	CBZB	03.10 ->	1,2	4	77	M4	ZKG0314	001
Roomster Praktik 1.2 TSI	CBZA	03.10 ->	1,2	4	63	M4	ZKG0328	027
Superb 2.8 V6	AMX	02.02 ->	2,8	6	142	M4	ZKG0357	002
Yeti 1.2 TSI	CBZB	09.09 ->	1,2	4	77	M4	ZKG0328	027
Yeti 1.2 TSI	CBZB	09.09 ->	1,2	4	77	M4	ZKG0314	001
<b>Tata Motors</b>								
Indica GLX 1.4	MPFI	01.07 ->	1,4	4	63	DIN	ZKG1261	013
Indigo SW GLX 1.4	MPFI	01.07 ->	1,4	4	63	DIN	ZKG1261	013
<b>Volkswagen</b>								
Bora 1.6	AEH, AKL, APF	10.98 - 05.05	1,6	4	74	M4	ZKG0359	003
Bora 1.6	AEH, APF	05.99 - 05.05	1,6	4	74	M4	ZKG0359	003
Bora 1.6	AVU, BFQ	08.00 - 05.05	1,6	4	75	M4	ZKG0379	001
Bora 1.6	AVU, BFQ	08.00 - 05.05	1,6	4	75	M4	ZKG3000	025
Caddy III 1.2 TSI	CBZA	09.10 ->	1,2	4	63	M4	ZKG0328	027
Caddy III 1.2 TSI	CBZA	09.10 ->	1,2	4	63	M4	ZKG0314	001
Caddy III 1.2 TSI	CBZB	09.10 ->	1,2	4	77	M4	ZKG0328	027
Caddy III 1.2 TSI	CBZB	09.10 ->	1,2	4	77	M4	ZKG0314	001
Caddy III 1.6	BGU, BSE, BSF	04.04 ->	1,6	4	75	M4	ZKG0379	001
Fox 1.0	CCNA	04.08 ->	1,0	4	54	M4	ZKG0323	001
Fox 1.0 Total Flex	CCNA	03.08 ->	1,0	4	54	M4	ZKG0323	001
Fox 1.4	BKR	04.05 ->	1,4	4	55	M4	ZKG0313	001
Golf Plus 1.2 TSI	CBZB	11.09 ->	1,2	4	77	M4	ZKG0328	027
Golf Plus 1.6	BSE, BSF, CCSA	05.05 ->	1,6	4	75	M4	ZKG0379	001
Golf Plus 1.6	BSE, BSF, CCSA	05.05 ->	1,6	4	75	M4	ZKG3000	025
Golf Plus 1.6 MultiFuel	CCSA, CHGA	11.07 ->	1,6	4	75	M4	ZKG0379	001
Golf Plus 1.6 MultiFuel	CCSA, CHGA	11.07 ->	1,6	4	75	M4	ZKG3000	025
Golf IV 1.6	AEH, AKL, APF	08.97 - 02.00	1,6	4	74	M4	ZKG0359	003
Golf IV 1.6	AVU, BFQ	08.00 - 06.05	1,6	4	75	M4	ZKG0379	001
Golf IV 1.6	AVU, BFQ	08.00 - 06.05	1,6	4	75	M4	ZKG3000	025
Golf IV 1.6	AVU, BSF	05.01 ->	1,6	4	75	M4	ZKG0379	001
Golf IV 1.6	AVU, BSF	05.01 - 06.06	1,6	4	75	M4	ZKG3000	025

Type	Motornummer Engine-No.	Baujahr Year	Liter Litre	Zyl. Cyl.	KW	Vert. Distr.	BBT-Nr. BBT-No.	Abb. Pict.
Golf IV Variant 1.6	AEH, AKL, APF	05.99 - 02.00	1,6	4	74	M4	ZKG0359	003
Golf V 1.6	BGU, BSE, BSF	01.04 ->	1,6	4	75	M4	ZKG0379	001
Golf V 1.6	BGU, BSE, BSF	01.04 - 11.08	1,6	4	75	M4	ZKG3000	025
Golf V Plus 1.2 TSI	CBZB	08.09 ->	1,2	4	77	M4	ZKG0314	001
Golf V Variant 1.6	BGU, CCSA, BSF, BSE	06.07 ->	1,6	4	75	M4	ZKG3000	025
Golf V Variant 1.6	BSE, BSF, CCSA	06.07 ->	1,6	4	75	M4	ZKG0379	001
Golf V Variant 1.6	BSE, BSF, CCSA	06.07 ->	1,6	4	75	M4	ZKG3000	025
Golf VI 1.2 TSI	CBZB	05.09 - 11.12	1,2	4	77	M4	ZKG0328	027
Golf VI 1.2 TSI	CBZB	05.09 - 11.12	1,2	4	77	M4	ZKG0314	001
Golf VI 1.2 TSI Cabriolet	CBZB	03.11 - 11.13	1,2	4	77	M4	ZKG0314	001
Golf VI 1.6	BSE, BSF, CCSA	10.08 ->	1,6	4	75	M4	ZKG0379	001
Golf VI 1.6	BSE, BSF, CCSA	10.08 - 11.12	1,6	4	75	M4	ZKG3000	025
Golf VI 1.6	CCSA, BSF, CMXA, BSE	10.08 - 11.12	1,6	4	75	M4	ZKG3000	025
Golf VI 1.6 BiFuel	CHGA	03.09 ->	1,6	4	75	M4	ZKG0379	001
Golf VI 1.6 BiFuel	CHGA	03.09 - 11.12	1,6	4	75	M4	ZKG3000	025
Golf VI Cabriolet 1.2 TSI	CBZB	03.11 - 11.13	1,2	4	77	M4	ZKG0328	027
Golf VI Variant 1.2 TSI	CBZA	07.10 ->	1,2	4	63	M4	ZKG0328	027
Golf VI Variant 1.2 TSI	CBZA	07.10 ->	1,2	4	63	M4	ZKG0314	001
Golf VI Variant 1.2 TSI	CBZB	08.09 ->	1,2	4	77	M4	ZKG0328	027
Golf VI Variant 1.2 TSI	CBZB	08.09 ->	1,2	4	77	M4	ZKG0314	001
Jetta III 1.6	BSE, BSF, CCSA	10.05 - 10.10	1,6	4	75	M4	ZKG3000	025
Jetta IV 1.2 TSI	CBZB	02.11 ->	1,2	4	77	M4	ZKG0328	027
Jetta IV 1.2 TSI	CBZB	02.11 ->	1,2	4	77	M4	ZKG0314	001
New Beetle 1.2 TSI	CBZB	07.11 ->	1,2	4	77	M4	ZKG0328	027
New Beetle 1.2 TSI	CBZB	10.11 ->	1,2	4	77	M4	ZKG0314	001
New Beetle 1.6	AYD, BFS	06.00 ->	1,6	4	75	M4	ZKG0379	001
New Beetle 1.6	AYD, BFS	06.00 - 09.10	1,6	4	75	M4	ZKG3000	025
New Beetle Cabriolet 1.2 TSI	CBZB	12.12 ->	1,2	4	77	M4	ZKG0328	027
New Beetle Cabriolet 1.2 TSI	CBZB	12.12 ->	1,2	4	77	M4	ZKG0314	001
New Beetle Cabriolet 1.6	BFS	01.03 ->	1,6	4	75	M4	ZKG0379	001
New Beetle Cabriolet 1.6	BFS	01.03 ->	1,6	4	75	M4	ZKG3000	025
Passat 1.6	AHL, ANA, ARM	10.96 - 11.00	1,6	4	74	M4	ZKG3000	025
Passat 1.6	ALZ	11.00 - 05.05	1,6	4	75	M4	ZKG3000	025
Passat 2.0	AZM	11.00 - 05.05	2,0	4	85	M4	ZKG3000	025
Passat 2.0 4motion	AZM	11.00 - 05.05	2,0	4	85	M4	ZKG3000	025
Passat 2.8 4motion	AMX, ATQ	11.00 - 05.05	2,8	6	142	M4	ZKG0357	002
Passat 2.8 Syncro	ACK, ALG, APR, AQD	05.97 - 08.00	2,8	6	143	M4	ZKG0357	002
Passat 2.8 V6	ACK, APR	01.97 - 11.00	2,8	6	142	M4	ZKG0357	018
Passat Variant 1.6	AHL, ANA, ARM	06.97 - 11.00	1,6	4	74	M4	ZKG3000	025
Passat Variant 1.6	ALZ	11.00 - 05.05	1,6	4	74	M4	ZKG3000	025
Passat Variant 2.0	AZM	11.00 - 05.05	2,0	4	85	M4	ZKG3000	025
Passat Variant 2.0 4motion	AZM	11.00 - 05.05	2,0	4	85	M4	ZKG3000	025
Polo 1.2 TSI	CBZB	11.09 ->	1,2	4	77	M4	ZKG0328	027
Polo 1.2 TSI	CBZB	06.09 ->	1,2	4	77	M4	ZKG0314	001
Polo 1.2 TSI	CBZC	05.11 ->	1,2	4	66	M4	ZKG0328	027
Touran 1.2 TSI	CBZB	05.10 ->	1,2	4	77	M4	ZKG0328	027
Touran 1.2 TSI	CBZB	05.10 ->	1,2	4	77	M4	ZKG0314	001
Touran 1.6	BGU, BSE, BSF	07.03 ->	1,6	4	75	M4	ZKG0379	001
Touran 1.6	BGU, BSE, BSF	07.03 - 05.10	1,6	4	75	M4	ZKG3000	025
<b>Volvo</b>								
C30 1.6	B 4164 S3	01.05 - 12.12	1,6	4	74	M4	ZKG1899	023
S40 II 1.6	B 4164 S3	01.05 ->	1,6	4	74	M4	ZKG1899	023
V50 1.6	B 4164 S3	01.05 ->	1,6	4	74	M4	ZKG1899	023

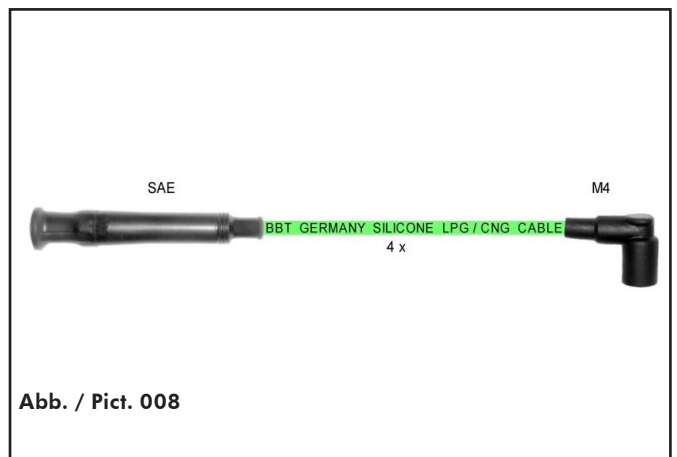
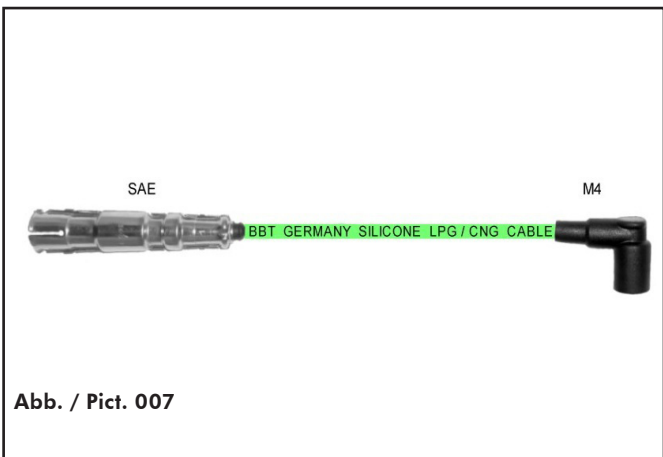
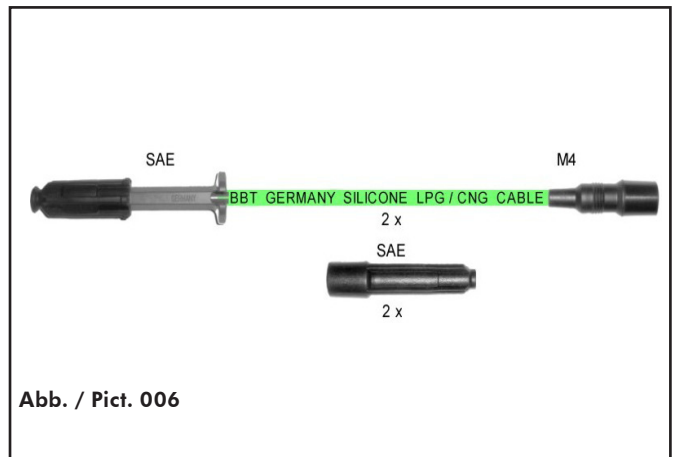
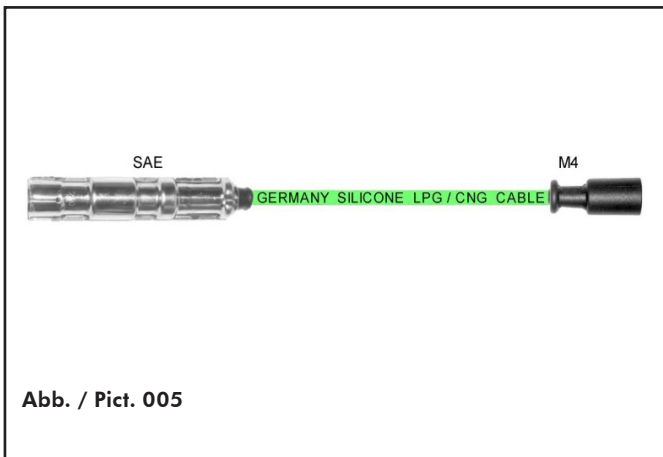
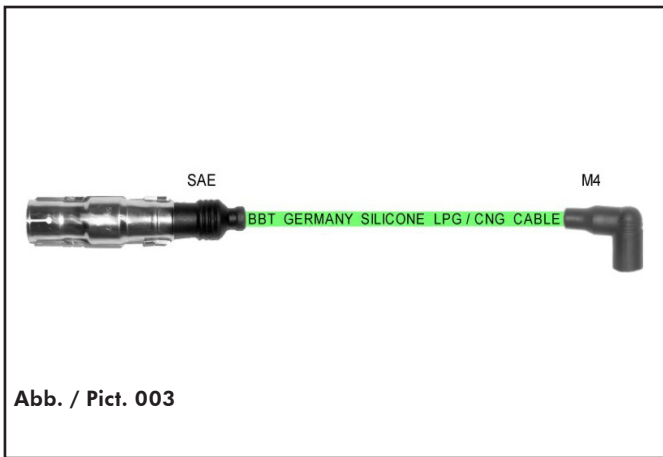
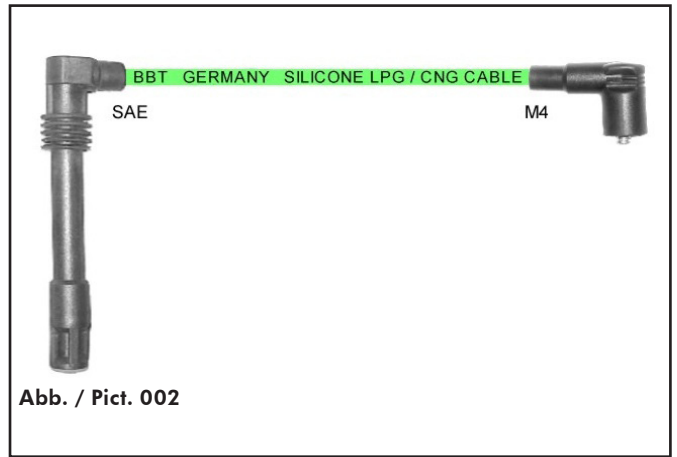
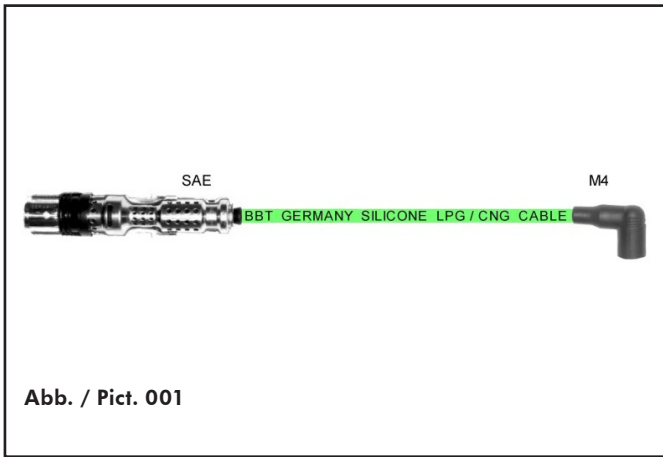

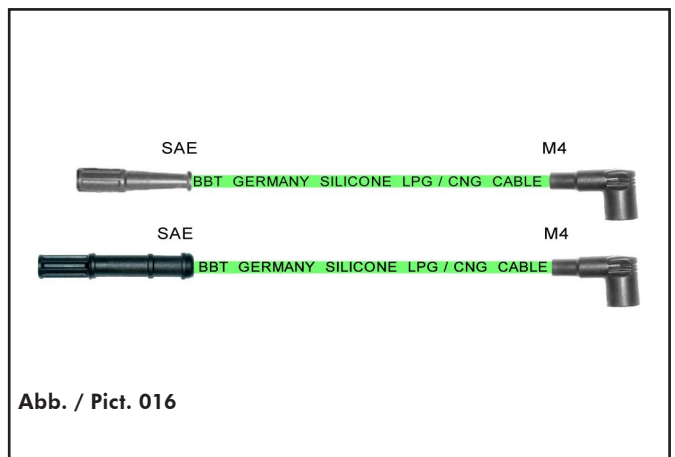
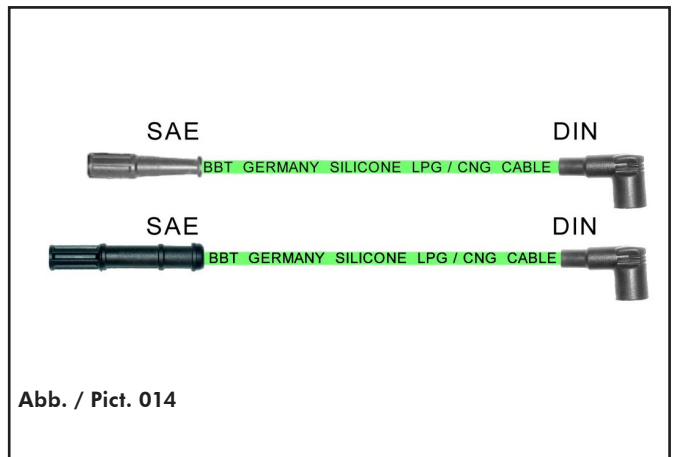
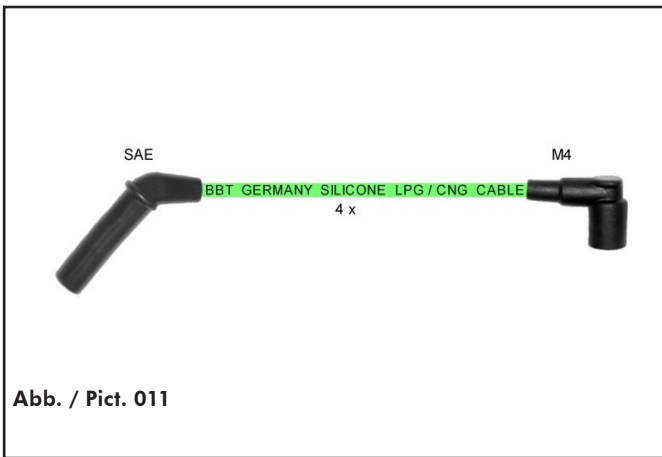
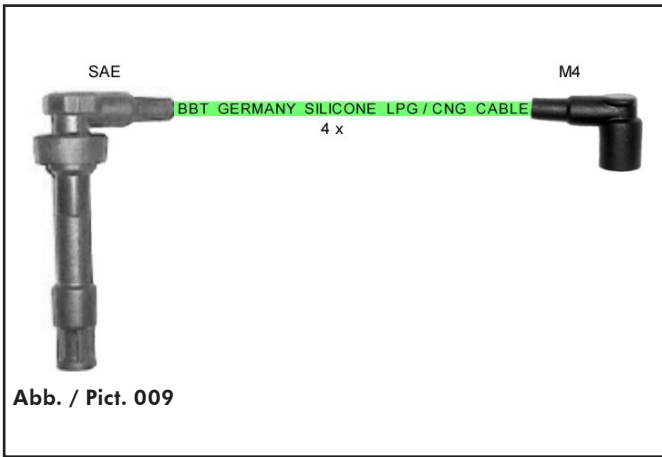

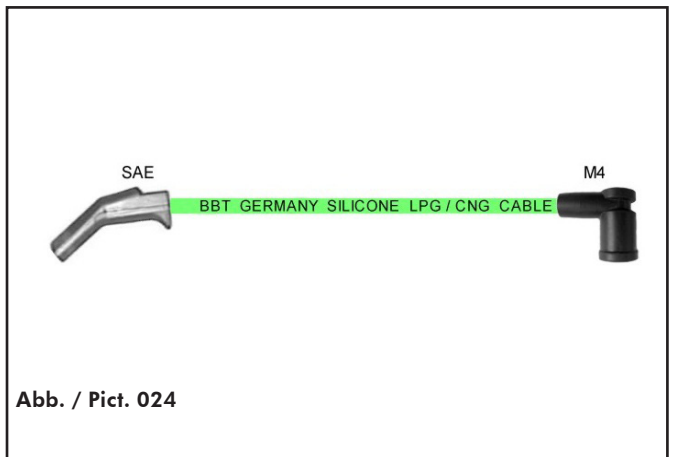
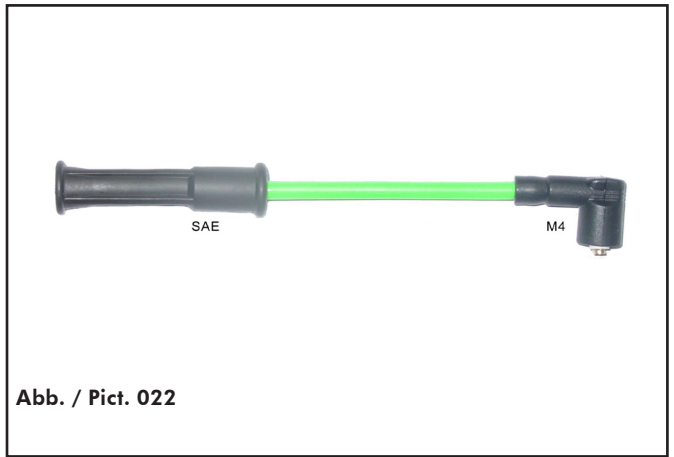
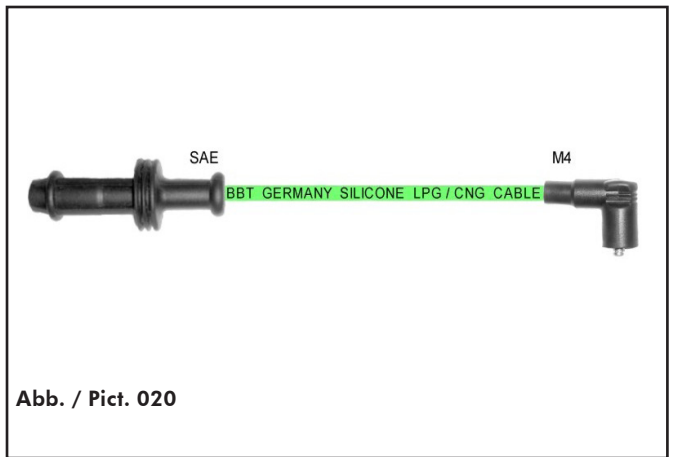
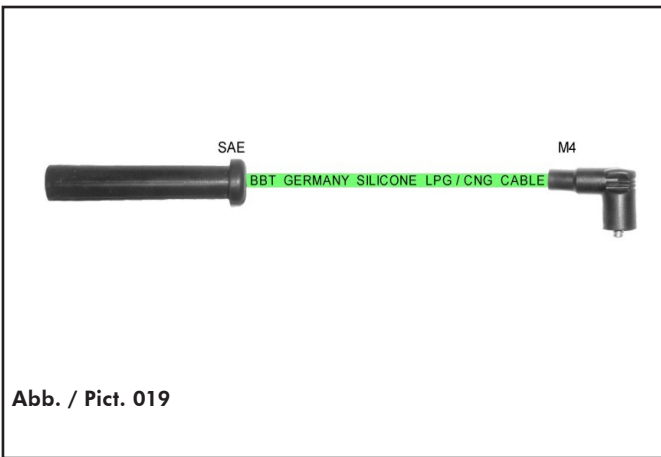
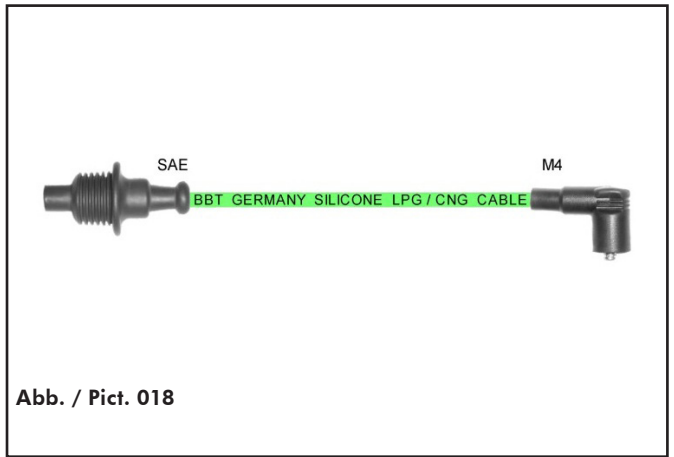

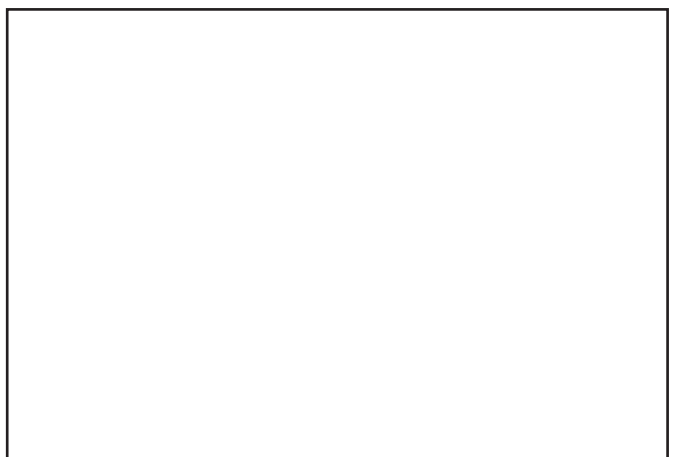
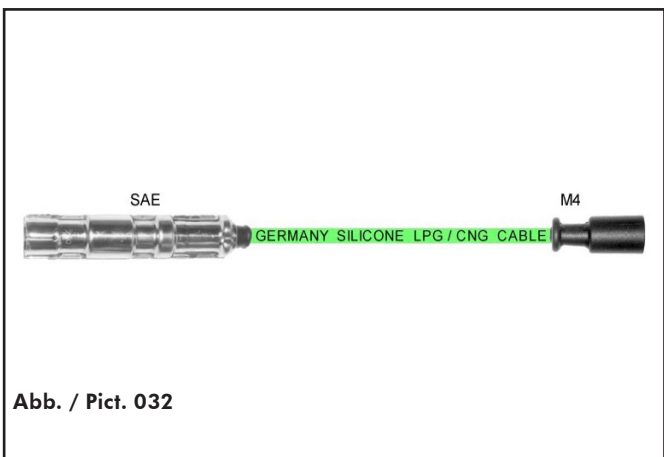
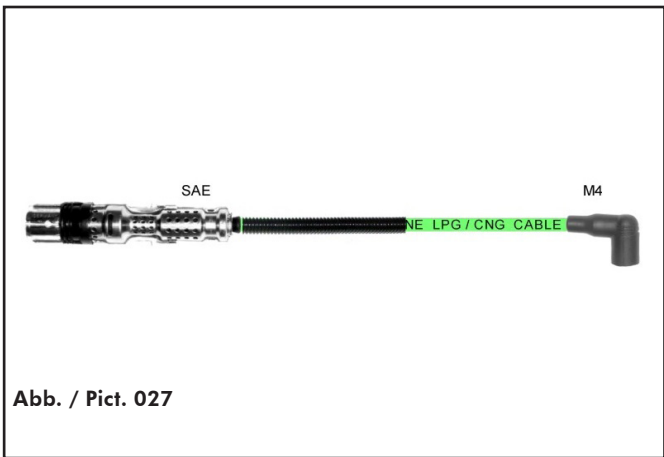
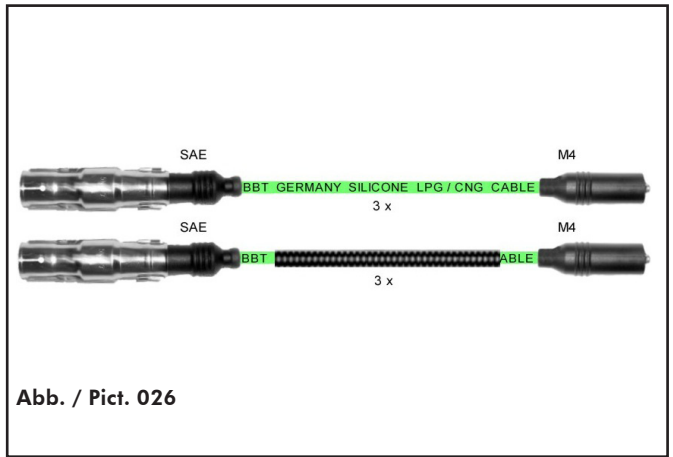
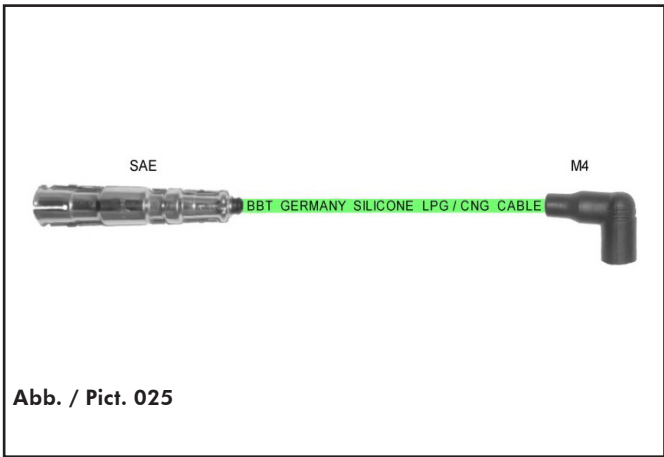

# VERGLEICHSLISTE / CROSS REFERENCE LIST

Referenz-Nr. Reference-No.	BBT-Nr. BBT-No.
-------------------------------	--------------------

<b>Beru</b>	<b>BBT</b>
0 300 891 572	ZKG0313
0 300 890 466	ZKG0415
0 300 890 793	ZKG1549
0 300 890 795	ZKG1555
0 300 890 983	ZKG1392
0 300 890 989	ZKG0359
0 300 891 044	ZKG1550
0 300 891 115	ZKG1890
0 300 891 128	ZKG1586
0 300 891 129	ZKG1107
0 300 891 182	ZKG0959
0 300 891 183	ZKG0949
0 300 891 219	ZKG0357
0 300 891 224	ZKG3000
0 300 891 338	ZKG0940
0 300 891 442	ZKG0437
0 300 891 477	ZKG1307
0 300 891 480	ZKG1248
0 300 891 488	ZKG0440
0 300 891 515	ZKG0444
0 300 891 543	ZKG1729
0 300 891 546	ZKG15112
0 300 891 549	ZKG1899
0 300 891 556	ZKG0452
0 300 891 598	ZKG1326
0 300 891 604	ZKG1571
0 300 891 608	ZKG1111
0 300 891 629	ZKG0314
ZEF 466	ZKG0415
ZEF 793	ZKG1549
ZEF 795	ZKG1555
ZEF 850	ZKG1749
ZEF 983	ZKG1392
ZEF 983	ZKG1392
ZEF 989	ZKG0359
ZEF 1044	ZKG1550
ZEF 1128	ZKG1586
ZEF 1129	ZKG1107
ZEF 1135	ZKG1752
ZEF 1182	ZKG0959
ZEF 1183	ZKG0949
ZEF 1219	ZKG0357
ZEF 1338	ZKG0940
ZEF 1442	ZKG0437
ZEF 1477	ZKG1307
ZEF 1480	ZKG1248
ZEF 1488	ZKG0440
ZEF 1515	ZKG0444
ZEF 1540	ZKG1729
ZEF 1546	ZKG15112
ZEF 1549	ZKG1899
ZEF 1556	ZKG0452
ZEF 1572	ZKG0313
ZEF 1598	ZKG1326
ZEF 1604	ZKG1571

Referenz-Nr. Reference-No.	BBT-Nr. BBT-No.
-------------------------------	--------------------

ZEF 1608	ZKG1111
ZEF 1629	ZKG0314
<b>BMW</b>	
12 12 1 247 512	ZKG0959
12 12 1 247 513	ZKG0959
12 12 1 247 523	ZKG0959
12 12 1 247 526	ZKG0959
12 12 1 709 206	ZKG0940
12 12 1 709 207	ZKG0940
12 12 1 709 208	ZKG0940
12 12 1 709 209	ZKG0940
<b>Bosch</b>	
0 986 356 310	ZKG0940
0 986 356 321	ZKG0357
0 986 356 333	ZKG0415
0 986 356 346	ZKG0379
0 986 356 359	ZKG0359
0 986 356 361	ZKG0949
0 986 356 390	ZKG3000
0 986 356 727	ZKG1550
0 986 356 767	ZKG1549
0 986 356 787	ZKG1392
0 986 356 830	ZKG1555
0 986 356 898	ZKG1752
0 986 356 970	ZKG1749
0 986 356 987	ZKG1107
0 986 357 141	ZKG1890
0 986 357 267	ZKG1898
0 986 357 285	ZKG1111
0 986 357 287	ZKG1729
<b>Chevrolet</b>	
25 183 557	ZKG1115
96 288 956	ZKG1111
96 984 145	ZKG1115
<b>Citroën</b>	
5967 L0	ZKG1549
5967 L3	ZKG1550
5967 L5	ZKG1555
5967 L6	ZKG1550
5967 L7	ZKG1549
5967 L8	ZKG1550
5967 L9	ZKG1555
5967 N1	ZKG1550
5967 N6	ZKG1555
9609 493 380	ZKG1549
<b>Dacia</b>	
77 00 273 826	ZKG1586
82 00 506 297	ZKG15112
<b>Daewoo</b>	
<b>BBT</b>	

Referenz-Nr. Reference-No.	BBT-Nr. BBT-No.
-------------------------------	--------------------

96 211 948	ZKG1107
96 288 956	ZKG1111
<b>Fiat</b>	
7776810	ZKG1322
46413088	ZKG1392
46749624	ZKG1307
55195775	ZKG1326
55195776	ZKG1326
<b>Ford</b>	
1335369	ZKG1899
1335371	ZKG1899
1335374	ZKG1899
1335377	ZKG1899
<b>Hyundai</b>	
27420-03000	ZKG1715
27420-03010	ZKG1715
27430-03000	ZKG1715
27430-03010	ZKG1715
27440-03000	ZKG1715
27440-03010	ZKG1715
27450-03000	ZKG1715
27450-03010	ZKG1715
27501-02D00	ZKG1752
27501-02W00	ZKG1752
27501-22B00	ZKG1752
27501-23A00	ZKG1749
27501-23B00	ZKG1749
27501-23B01	ZKG1749
27501-23B70	ZKG1749
27501-23B70	ZKG1749
<b>Mazda</b>	
1E05 18 160 B	ZKG1729
1E05 18 170 B	ZKG1729
1E05 18 180 B	ZKG1729
1E05 18 190 B	ZKG1729
<b>Mercedes</b>	
102 150 19 18	ZKG0415
102 150 20 18	ZKG0415
102 150 21 18	ZKG0415
102 150 28 18	ZKG0415
102 150 29 18	ZKG0415
112 150 01 18	ZKG0437
112 150 02 18	ZKG0437
112 150 03 18	ZKG0440
112 150 04 18	ZKG0440
266 150 02 18	ZKG0452
266 150 06 18	ZKG0452
266 150 07 18	ZKG0452
272 150 03 18	ZKG0487
A 112 150 01 18	ZKG0437



## I. Allgemeines

1. Diese Bedingungen gelten für alle Lieferungen, gleichgültig ob Kauf oder Werklieferungsverträge. Wir liefern nur zu diesen Bedingungen, die zugleich auch für sämtliche künftigen Vertragsbeziehungen gelten, auch wenn sie nicht ausdrücklich einbezogen werden.
2. Geschäfts- und Einkaufsbedingungen von Vertragspartnern widersprechen wir hiermit ausdrücklich. Diese werden keinesfalls Vertragsgegenstand. Abweichende Regelungen gelten nur dann, wenn sie von uns schriftlich vor Vertragsabschluss bestätigt worden sind. Wir sind nicht verpflichtet, Vertragsformblättern oder Geschäftsbedingungen von Vertragspartnern förmlich zu widersprechen und zwar auch dann nicht, wenn in diesen Geschäftsbedingungen die Gültigkeit derselben als ausdrückliche Bedingung für den Geschäftsabschluss genannt ist. Wir erklären, ausschließlich aufgrund der vorliegenden Geschäftsbedingungen Verträge abschließen zu wollen.
3. Erfüllungsort für beide Teile ist unser Sitz, Gerichtsstand nach unserer Wahl Ansbach oder Nürnberg.
4. Die Verantwortung für die Auswahl der Produkte und die mit ihnen beabsichtigten Zwecke liegt ausschließlich beim Kunden, es sei denn, wir geben im Einzelfall besondere schriftliche Zusicherungen oder Garantien ab.
5. Wir sind berechtigt, bei erstmaliger Geschäftsbeziehung vor Auftragsübernahme geschäftliche Referenzen anzufordern, insbesondere eine Bankverbindung mit einem Ansprechpartner.

## II. Preise

1. Unsere Preise verstehen sich, soweit nicht schriftlich anders vereinbart, ab Weihenzell, ausschließlich Verpackung und Verladung und Transport rein netto, zuzüglich der gesetzlichen Mehrwertsteuer.
2. Wir sind berechtigt, unsere Rechnungen auf elektronischem Wege zur versenden.

## III. Zahlungsstörungen

1. Gerät unser Kunde mit einer Zahlungsverpflichtung in Rückstand, so schuldet er Zinsen in Höhe von 8%-Punkten über dem jeweiligen Basiszinssatz.
2. Wir sind zum Vertragsrücktritt berechtigt, wenn sich die wirtschaftlichen Verhältnisse des Kunden verschlechtern oder schlechte Verhältnisse bekanntwerden. Ebenso, wenn Zahlungsverpflichtungen länger als zwei Wochen trotz Mahnung nicht erfüllt werden. Ist Zahlung in Teilbeträgen gestattet, so wird der Rest sofort fällig, wenn Zahlungstermine um mehr als zwei Wochen überschritten werden. Bei Abrufaufträgen sind wir berechtigt, vom nicht erfüllten Teil der Abrufvereinbarung zurückzutreten und Schadensersatz wegen Nichterfüllung der gesamten Abrufvereinbarung zu verlangen, wenn der Kunde mit der Abnahme auch nur eines Teils der vereinbarten Mengen in Verzug gerät. Gleiches gilt, wenn der Kunde mit der Bezahlung bisheriger Lieferungen in Verzug und nicht in der Lage ist, weitere Leistungen nur gegen Vorauszahlungen oder Sicherheitsleistung entgegenzunehmen.
3. Aufrechnung mit bestrittenen und nicht rechtskräftigen Gegenansprüchen ist nicht statthaft. Gleiches gilt für das Zurückbehaltungsrecht.

## IV. Schadensersatz

Erfüllt der Kunde einen Vertrag nicht oder können wir von unserem Rücktrittsrecht Gebrauch machen, so erhalten wir als Entschädigung unseres entgangenen Gewinns einen pauschalen Schadensersatz in Höhe von 25% des vereinbarten Preises zuzüglich des Entgelts für bereits erbrachte Arbeitsleistungen und Materialverbrauch ohne Nachweis, unbeschadet des Rechts beider Seiten, einen höheren oder niedrigeren Schaden nachzuweisen.

## V. Eigentumsvorbehalt

1. Sämtliche Lieferungen bleiben bis zur vollständigen Zahlung unserer sämtlichen Forderungen aus der Geschäftsbeziehung unser Eigentum. Sofern im Einzelfall eine Übersicherung von mehr als 25% eintreten sollte, verpflichten wir uns zur Freigabe von Gegenständen oder Forderungen nach Auswahl des Kunden.
2. Veräußerung und Verarbeitung von Vorbehaltsware ist zulässig. Insofern tritt uns der Kunde die daraus entstehenden Forderungen gegen Dritte bereits jetzt ab. Der Kunde ist widerruflich berechtigt, die Forderungen einzuziehen.
3. Der Eigentumsvorbehalt berechtigt uns im Falle des Zahlungsverzuges zur sofortigen Wiederinbesitznahme oder Geltendmachung der Rechte aus der Abtretung. Der Kunde verzichtet auf die Einwendung der unzulässigen Eigenmacht und ermächtigt uns von vornherein zum freihändigen Verkauf der Gegenstände auf seine Kosten.
4. Wird die Vorbehaltsware vom Käufer verarbeitet, so wird vereinbart, dass die Verarbeitung im Namen und für Rechnung des Verkäufers als Hersteller erfolgt und der Verkäufer unmittelbar das Eigentum oder – wenn die Verarbeitung aus Stoffen mehrerer Eigentümer erfolgt oder der Wert der verarbeitenden Sache höher ist als der Wert der Vorbehaltsware – das Miteigentum (Bruchteilseigentum) an der neu geschaffenen Sache im Verhältnis des Werts der Vorbehaltsware zum Wert der neu geschaffenen Sache erwirbt. Für den Fall, dass kein solcher Eigentumserwerb beim Verkäufer eintreten sollte, überträgt der Käufer bereits jetzt sein künftiges Eigentum oder – im oben genannten Verhältnis – Miteigentum an der neu geschaffenen Sache zur Sicherheit an den Verkäufer.

Wird die Vorbehaltsware mit anderen Sachen zu einer einheitlichen Sache verbunden oder untrennbar vermischt und ist eine der anderen Sachen als Hauptsache anzusehen, so überträgt der Verkäufer, soweit die Hauptsache ihm gehört, dem Käufer anteilig das Miteigentum an der einheitlichen Sache in dem in Satz 1 genannten Verhältnis.

## VI. Übergabe

1. Der Versand erfolgt stets auf Rechnung und Gefahr des Kunden. Mit der Übergabe an den Spediteur/Frachtführer geht die Gefahr über, spätestens beim Verlassen unseres Geschäftsrückstücks.
2. Bei Export der gekauften Ware ist der Kunde verpflichtet, die notwendigen Export- und Zollbewilligungen, sowie sonstigen Einfuhrunterlagen auf seine Kosten zu beschaffen. Wir haften nicht für die Zulässigkeit der Ausfuhr der Ware und deren Übereinstimmung mit besonderen rechtlichen und technischen Vorschriften des Importlandes.
3. Eine Versicherung der Ware für den Transport erfolgt durch uns nur bei Vorliegen eines Auftrags des Kunden.

## VII. Haftung

1. Der Kunde ist verpflichtet, bei Meidung des vollständigen Rechtsverlustes die Vollständigkeit und Mangelfreiheit der Ware sofort nach Entgegennahme zu überprüfen und Beanstandungen schriftlich spätestens am nächsten Tage mitzuteilen. Bei berechtigten Mängelrügen haben wir das Recht, die Ware zurückzunehmen und unverzüglich Ersatz zu leisten.
2. Abweichungen in der Beschaffenheit der gelieferten Gegenstände können nicht beanstandet werden, sofern sie handelsüblich und für den vorgesehenen Gebrauch nicht erheblich sind. Jegliche Eingriffe von außen, die mit einem geltend gemachten Mangel im Zusammenhang stehen, heben die Gewährleistung auf.
3. Wir können wegen Nichterfüllung oder Verzugs nur in Anspruch genommen werden, wenn uns Vorsatz oder grobe Fahrlässigkeit nachgewiesen werden kann. Gleiches gilt auch für Mangelfolgeschäden, für die wir ansonsten nicht haften. Ist uns Ersatz oder Nachbesserung, zu der wir ebenfalls berechtigt sind, in angemessener Frist nicht möglich, so kann der Kunde Rückgängigmachung des Vertrages verlangen. Die Haftungsbeschränkung gilt nicht bei Personenschäden oder wenn es sich um eine Verletzung vertragswesentlicher Pflichten handelt. Vertragswesentlich sind die Verpflichtung zur rechtzeitigen Lieferung sowie Beratungs-, Schutz- und Obhutspflichten, die dem Kunden die vertragsgemäße Verwendung des Liefergegenstandes ermöglichen sollen oder den Schutz von Leib oder Leben von Personal des Kunden oder den Schutz von dessen Eigentum vor erheblichen Schäden bezwecken. Im Falle einer Haftung für einfache Fahrlässigkeit ist unsere Ersatzpflicht für Sachschäden und daraus resultierende weitere Vermögensschäden auf einen Betrag in Höhe der derzeitigen Deckungssumme unserer Produkthaftpflichtversicherung oder sonstigen Haftpflichtversicherung beschränkt, auch wenn es sich um eine Verletzung vertragswesentlicher Pflichten handelt.
4. Ansprüche gegen uns, gleichgültig aus welchem Rechtsgrund, mit Ausnahme bei Personenschäden verjähren insoweit innerhalb von 12 Monaten, soweit nicht eine kürzere gesetzliche Verjährung gilt.
5. Unser Kunde ist gehalten, gelieferte Gegenstände vor einer Weiterverarbeitung sorgfältig zu überprüfen und stellt uns deshalb von Produkthaftpflichtansprüchen frei.
6. Rücksendungen dürfen nur nach vorheriger Einwilligung durch BBT erfolgen.

## VIII. Lieferungen

1. Wir streben termingerechte Auslieferung an. Liefertermine sind allerdings nur verbindlich, wenn sie schriftlich kalendermäßig vereinbart sind. Können wir gleichwohl nicht liefern, so ist uns zwei Wochen nach Ablauf des Liefertermins eine schriftliche Nachfrist zu setzen, die mindestens einen Monat betragen muß.
2. Eine angemessene Lieferzeitverlängerung tritt immer bei unvorhergesehenen Hindernissen, auch bei Änderungs- oder Ergänzungswünschen des Kunden, die die Art des Produkts oder den Umfang der Lieferung betreffen, ein.

## IX. Rechtswahl

Sämtliche Rechtsbeziehungen unterliegen ausschließlich deutschem Recht. Die Anwendung internationaler Rechtsvorschriften, insbesondere die Anwendung des UN-Kaufrechts ist ausgeschlossen.

## X. Sonstiges

1. Wenn in diesen Geschäftsbedingungen Schriftform genannt ist, so ist darunter auch Telefax und E-Mail (mit Eingangs- oder Lesebestätigung) zu sehen.
2. Es wird vereinbart, dass mündliche Nebenabreden zu Verträgen nur wirksam sind, wenn sie schriftlich bestätigt werden. Ein Verzicht auf die Einhaltung dieser Vorschrift setzt Schriftform voraus.
3. Wir behalten uns vor, nicht in deutscher und englischer Sprache abgegebene Willenserklärungen als nicht erfolgt anzusehen.
4. Sollte eine oder mehrere Bestimmungen dieser Bedingungen ganz oder teilweise unwirksam oder nichtig sein oder werden, so wird dadurch die Wirksamkeit des Bedingungswerks im Übrigen nicht berührt. Der Kunde und wir sind in diesem Fall gehalten, die betreffende Bestimmung durch eine wirksame Regelung zu ersetzen, die dem gewollten wirtschaftlichen Zweck am nächsten kommt. Gleiches gilt im Falle einer Lücke.

## I. General

1. These conditions subject to all deliveries, no matter if purchase or order acceptance ex works. We only deliver to these conditions, which are at the same time valid for all further business agreements, even if they are not included especially.
2. We herewith contradict business and purchasing conditions of contract partners. These will under no circumstances become object of agreement. Deviations from our contracts only apply if confirmed by us in writing before conclusion of contract. We are not obliged to contradict the contract forms or general terms and conditions of the customer, even not if the validity of the terms and conditions is mentioned as an express condition for the business transaction. We (herewith) declare that we exclusively intend to conclude contracts on the basis of the present terms and conditions.
3. Place of settlement for both parties is our place, place of jurisdiction is, chosen by us, Ansbach or Nürnberg.
4. The responsibility for the selection of goods and the intended purpose for them is up to the customer. In single cases we give special written assurances or guarantees.
5. We are entitled to request business references at the first business contact before acceptance of order. This means in particular bank details and a contact person.

## II. Prices

1. If not agreed otherwise in writing, our prices are valid net ex Weihenzell, exclusive lost for packing, despatch and transport.
2. We are entitled to send our invoices by electronic means.

## III. Delays in Payment

1. If our customer gets in delays with payment obligations, he owes us interests of 8 % over the basic rate of interest at that time.
2. We are entitled to resign from the contract if our customers' economic circumstances deteriorate or worse circumstances get public, just as if payment obligation is not fulfilled within 2 weeks despite of reminder. If payment is allowed in partial amounts, the rest will get due immediately after payment dates are exceeded more than 2 weeks. If the customer gets in delay with the purchase, even of a part, of the agreed quantities of orders on call, we are entitled to resign from the not fulfilled part of the agreement on call and to demand compensations because of not accomplishing the complete agreement on call. The same applies if the customer gets in delay with the payment of previous deliveries and is not able to accept further services only against advance payments and purchaser security.
3. Settlements in account with not agreed, unclear or not valid demands are not permitted.

## IV. Compensation

If the customer does not fulfil a contract or if we can use our right to resign from the contract, we get a lump sum of 25 % from the agreed price for compensation of our lost profit in addition to already effected labour cost and material used, without proof not having the right of both sides to proof a higher or lesser damage.

## V. Reservation of Ownership

1. Goods supplied remain our property until payment of all our demands under the business contract with the customer has been received.
2. Sale and manufacturing of goods with reservation is admitted. In so far the customer withdraws the arising demands against third parties already now. The customer is revocably entitled to draw in the demands.
3. The reservation of property entitles us to the immediate re-taking of possession in case of payment delays. The customer resigns the objection and authorizes us from the beginning to sell the goods on his cost.
4. If the goods subject to reservation are processed by the customer then it is agreed that the processing is done in the name and for account of the supplier as manufacturer and the supplier shall acquire the ownership directly or – if the processing is of material from several owners or if the value of the processed item exceeds that of the goods subject to reservation – the co-ownership (fractional ownership) of the newly created item in the ratio of the goods subject to reservation to the value of the newly created goods. In case that no such acquisition of property should occur for the supplier, the customer shall henceforth transfer his future property or – in the above relation – co-ownership of the newly created item to the supplier's security. If the goods subject to reservation are combined or inseparably mixed with other goods to a single item and if one of the other can be considered as the main item, then the supplier shall, insofar as the main item belongs to him, transfer the co-ownership proportionally to the customer of the uniform item in the ratio stated in sentence 1.

## VI. Transfer

1. Goods are always forwarded at purchaser's risk and charge. With transfer to the forwarder the risk changes sides, at latest leaving our business site. In case the purchased goods shall be exported, the customer shall be obliged to obtain the necessary authorisations for export and customs as well as other importing documents at his own expenses. We are not liable for the admissibility of the exportation of the goods and its accordance with particular legal and technical regulations of the importing country.
2. An insurance for the goods during transport is only made by us if we have been received an order by the customer.

## VII. Responsibility

1. The customer is obliged to check completeness and condition of goods immediately after receipt and to inform us in writing about claims on the next day at latest, otherwise warranty expires. If notices of defects are justified, we have the right to take the goods back and supply a replacement immediately.
2. Discrepancies in the condition of the delivered goods cannot be objected as long as they are customary and for the intended purpose not considerable. Manipulation, which is in a relation with a notified claim, liability also expires.
3. Claim for non-accomplishment or delay is only possible, if we can be proved intention or coarse negligence. This also applies to damages in sequence to deficiencies. If we are not in a position to supply replacement or improvement – to which we are also entitled – within a reasonable period of time, the customer can require the cancellation of the contract. The limitation of liability shall not apply to personal injury or to violation of essential contractual duties. The obligation to deliver in time is essential as well as the duties to advice, protect and care which shall enable the customer to use the delivery item according to agreement or contribute to the protection of life and limb of the customer's personnel or to the protection of its title against substantial damage. Our liability to pay compensation for property damage and further resulting financial losses is limited to an amount of the current sum insured in the event of liability for simple negligence, even if it is a violation of essential contractual duties.
4. Claims against us no matter the cause become prescriptive after 12 month with exception of personal injury.
5. Our customer is obliged to check delivered goods carefully before manufacturing or using them. Therefore we are released from product liability claims.
6. No merchandise is to be returned to us without agreement.

## VIII. Deliveries

1. We endeavour to deliver on time. Delivery dates are only binding if they are agreed with a firm date in writing. If we are nevertheless not able to deliver, a written set term of at least 4 weeks has to be agreed. This has to take place 2 weeks after expiration of the delivery date.
2. A suitable extension of the delivery time always takes place because of unexpected obstacles, force majeure and also due to alterations or additional requirements of the customer which concern the type of the products and the scope of the delivery.

## IX. Choice of law

All legal relations are under the jurisdiction of German law. The application of international legislations is excluded, in particular the application of the UN Sales Convention.

## X. Others

1. If written form is mentioned in these terms and conditions, fax and e-mail is meant by this as well (including acknowledgement of receipt and read confirmation).
2. It is agreed that all verbal agreements besides to the contracts are only effective, if they are confirmed in writing. A renunciation to fulfil this regulation has to be done in writing.
3. We reserve the right to consider declaratory acts, which are not given in German or English language, as not taken place.
4. Should one or more provisions of this agreement be totally or partially legally ineffective or invalid, the validity of the terms and conditions shall thereby not be affected. In this case, the customer and us are obliged to replace the concerning provision with an effective regulation which come closest to the intended economic purpose. The same applies in the event of a gap.