

# BBT

Automotive Components GmbH  
German Technology

LAMBDA SONDEN

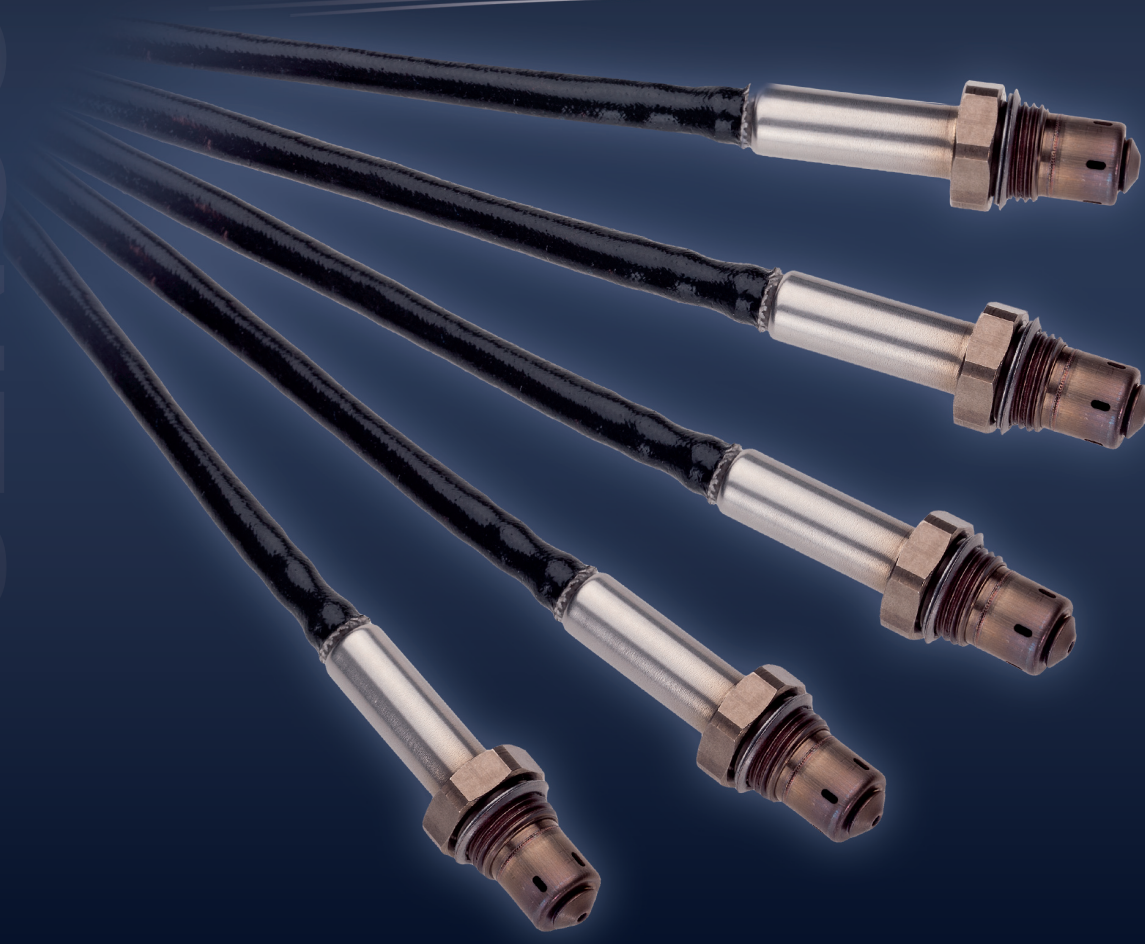

OXYGEN SENSORS

SENSORS

SENSORIK

# BBT Automotive Components GmbH

*BBT* hat sich im Verlauf von 2 Jahrzehnten durch Qualität, Wettbewerbsfähigkeit, Kompetenz und Zuverlässigkeit im Ersatzteilmarkt als starke Marke etabliert.

*BBT* ist ständig im Einsatz, um Kunden freundlich und fachkundig zu betreuen sowie mit aktuellen Produktinformationen zu versorgen. Dabei stehen termingerechte Lieferungen und einwandfreie Qualität immer im Vordergrund.



*BBT* is a strong and well established brand which kept its focus on quality, reliability and competitiveness in the automotive aftermarket during a history of two decades.

*BBT* is fully committed to provide customers with an excellent service of experts and detailed information about all products. Priority is the product quality along with deliveries on time at competitive prices to serve our customers needs.



## Inhaltsverzeichnis

### List of Contents

Seite / page	1 - 6.....	Einführung / introduction
Seite / page	7 - 24.....	Anwendungsliste / application list
Seite / page	25 - 30.....	Abbildungen / pictures
Seite / page	31 - 35.....	Vergleichsliste / cross reference list

## Allgemeine Informationen

### General information

Durch die ständige Weiterentwicklung des Programms ist es möglich, dass sich unsere Produktdaten ändern. BBT Automotive Components GmbH behält sich das Recht vor, Ausführung und Artikelnummern der in diesem Katalog gezeigten Produkte jederzeit und ohne Ankündigung zu ändern. Alle Rechte vorbehalten.

Die Gegenüberstellung von BBT Artikelnummern zu Fahrzeugherstellern oder zu Herstellern von anderen Marken dient ausschließlich zu Vergleichszwecken. Technische Unterschiede sind bauart- und herstellerbedingt möglich, wofür eine Gewährleistung ausgeschlossen ist. Verbindlich bei der Bestellung ist jeweils die BBT Artikelnummer.

Due to continued research and development of our program, BBT Automotive Components GmbH reserves the right to modify all product data without further notice. All rights reserved.

The cross-reference of BBT article numbers to car manufacturers or manufacturers of other brands is only for comparative purposes. Technical differences may occur in relation to construction and manufacturer, therefore warranty can not be granted. When placing the order, the BBT article number is binding.

Bei Rückfragen stehen wir Ihnen gerne jederzeit zur Verfügung.  
In case of queries do not hesitate to contact us.

#### *Headquarters*



BBT Automotive Components GmbH  
Gewerbering 12  
91629 Weihenzell  
Germany  
Info@bbt-automotive.de  
Phone: +49(0)9802 - 95211 0  
Fax: +49(0)9802 - 95211 95



# Lambdasonde | Einführung

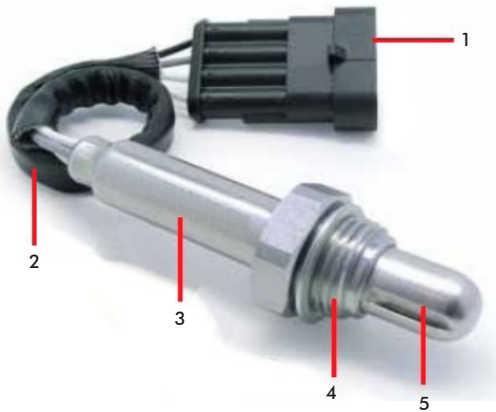

## 1. Anschluss

- Feuchtigkeit und sonstige Fremdstoffe beeinflussen die Lambdasonde.
- Nur zugelassene Kontaktsprays benutzen.

## 2. Kabel

- Hitze vermeiden, vom Auspuffrohr und anderen heißen Fahrzeugteilen fernhalten.
- Kabelzugspannung vermeiden.
- Lange frei hängende Kabel vermeiden, sie könnten zu schwingen beginnen oder sich sogar an anderen Teilen oder Gegenständen verfangen.

## 3. Sondenkörper

- Der Sondenkörper ist vor Schmutz und plötzlichem Bespritzen mit kaltem Wasser zu schützen.
- Die Sonde von allen Beschichtungen jeder Art freihalten.
- Sonde nicht mit Hochdruck-Wasserstrahl besprühen.

## 4. Gewinde

- Vor dem Einschrauben der Sonde das Gewinde mit Kupferfett schmieren.

## 5. Sondennase

- Stöße gegen die Nase vermeiden, um eine Beschädigung des empfindlichen Keramikelements zu verhindern.
- Kein Schmierfett auf die Sondennase bringen.
- Nichts auf die Sonde sprühen.
- Verwendung von Kraftstoffzusätzen vermeiden.

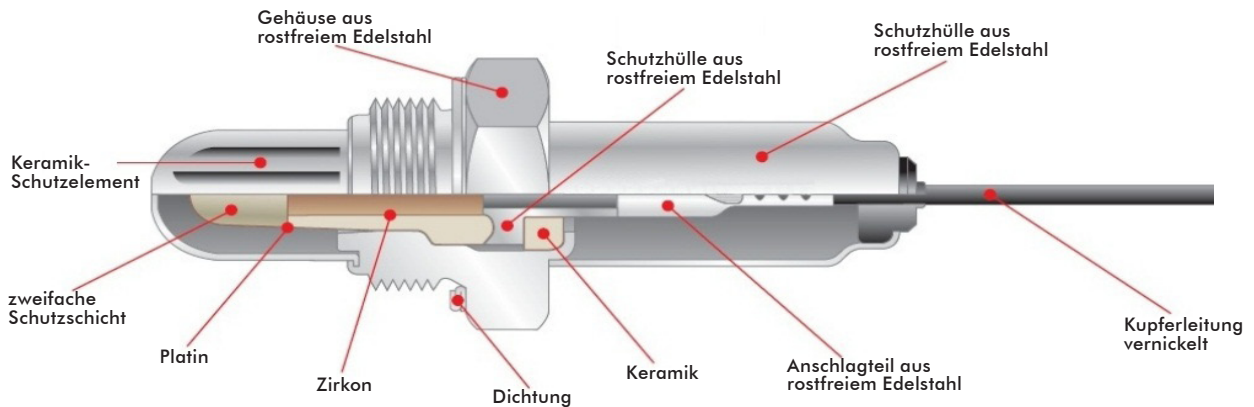

## Einbauort einer Lambdasonde

Jeder Neuwagen seit der Einführung des Katalysators in den USA, Schweden, Schweiz (70er) und Deutschland (1985) werden Lambdasonden eingesetzt. Sie befindet sich im Auspuffrohr vor dem Katalysator, wo sie den Sauerstoffgehalt der Abgase misst und die ECU (engine control unit) entsprechend informiert. Das ECU berechnet dann die erforderliche Anpassung des Kraftstoff-Luftgemisches. Die genaue Einbauposition der Lambdasonde ist verschieden, je nachdem, ob das betreffende Fahrzeug eine Abgasanlage in V- oder Reihenmotorausführung hat und je nach Marke und Modell.

Viele neuere Fahrzeuge haben eine zweite Lambdasonde, die hinter dem Katalysator eingebaut ist, sowie eine vor dem Katalysator eingebaute Sonde. Die Lambdasonde vor dem Katalysator ist die Regelsonde, das Motorsteuergerät bei der Regelung des Kraftstoff-Luftverhältnisses unterstützt. Die nach dem Katalysator eingebaute Lambdasonde ist die Diagnosesonde, diese überwacht die Funktionsweise des Katalysators.

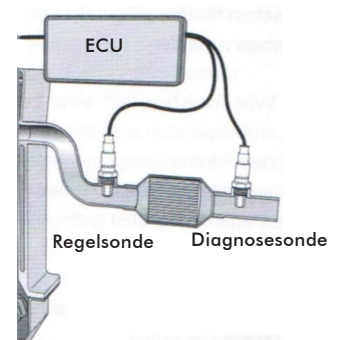



# Lambdasonde | Installation

## Universaleinbau

### Benötigtes Werkzeug:

- Seitenschneider
- Abisolierzange
- Crimpzange (Ratschenfunktion) mit roter Backentasche für isolierte Anschlüsse
- Heißluftpistole
- Gewindeschneider zur Gewindereinigung (M18x1,5 -> für die meisten Sonden)
- Drehmomentschlüssel mit geeignetem Lambdasondensteckeinsatz, Größe 22

1. Kabel der neuen Lambdasonde auf die richtige Länge zuschneiden. Die neue Sonde mit dem alten Anschluss muss genauso lang sein wie ursprünglich die alte Sonde mit dem Stecker war.
2. Die alten Sondenkabel auf die richtige Länge zu schneiden.
3. Kabelenden 7 mm weit abisolieren.
4. Stoßverbinder crimpen.
5. Isolierung der Stoßverbindungen mit Heißluft aufschumpfen, bis die Verbindung versiegelt.
6. Ggf. das Gewinde im Auspuffrohr mit einem Nachschneider zur Gewindereinigung reinigen.
7. Sonderngewinde mit Kupferfett schmieren
8. Sonde mit einem Drehmomentschlüssel auf den vorgeschriebenen Wert festziehen. Darauf achten, dass die Kabel nicht beschädigt werden.



## Einbau der Lambdasonde



### Benötigtes Werkzeug:

- Gewindeschneider zur Gewindereinigung (M18x1,5 -> für die meisten Sonden)
- Drehmomentschlüssel mit geeignetem Lambdasondensteckeinsatz, Größe 22

1. Gewinde im Auspuffrohr, falls erforderlich mit einem Gewindeschneider reinigen.
2. Sonderngewinde mit Kupferfett schmieren
3. Sonde mit einem Drehmomentschlüssel auf den vorgeschriebenen Wert festziehen. Darauf achten, dass die Kabel nicht beschädigt werden.



### Kabellegende

Signal Ausgang:	schwarz
Masse:	grau
Heizung 12V:	weiß (+/-)
 Lambdasonde	
 Heiz-Widerstand	

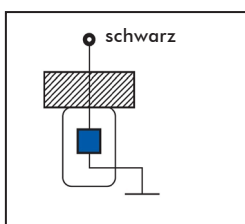

1 Kabel

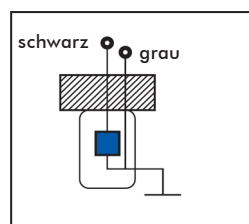

2 Kabel

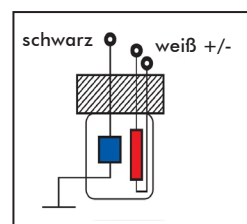

3 Kabel

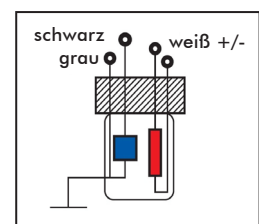

4 Kabel



# Oxygen sensor | introduction

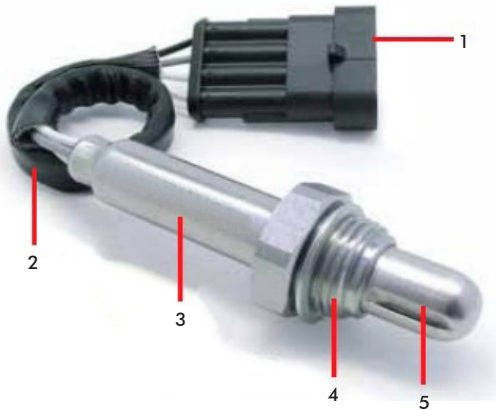

## 1. Connector

- Moisture and other foreign substances will easily influence the sensor.
- Use only permitted contact sprays.

## 2. Cable

- Avoid heat, keep away from the exhaust-pipe or other hot vehicle parts.
- Avoid cable tension.
- Long, free-hanging cabling: it could start to swing or even get caught by other parts or objects.

## 3. Sensor body

- Keep the body protected from dirt and sudden cold water splashes.
- Do not spray the sensor with high-pressure water.
- Keep the sensor free from all types of coatings.

## 4. Thread

- Grease the thread with copper grease before installation.

## 5. Sensor nose

- Avoid any sudden knocks to prevent damage to the sensitive ceramic element substances.
- Do not put grease on the sensor.
- Do not spray anything on the sensor nose.
- Avoid the use of fuel additives.

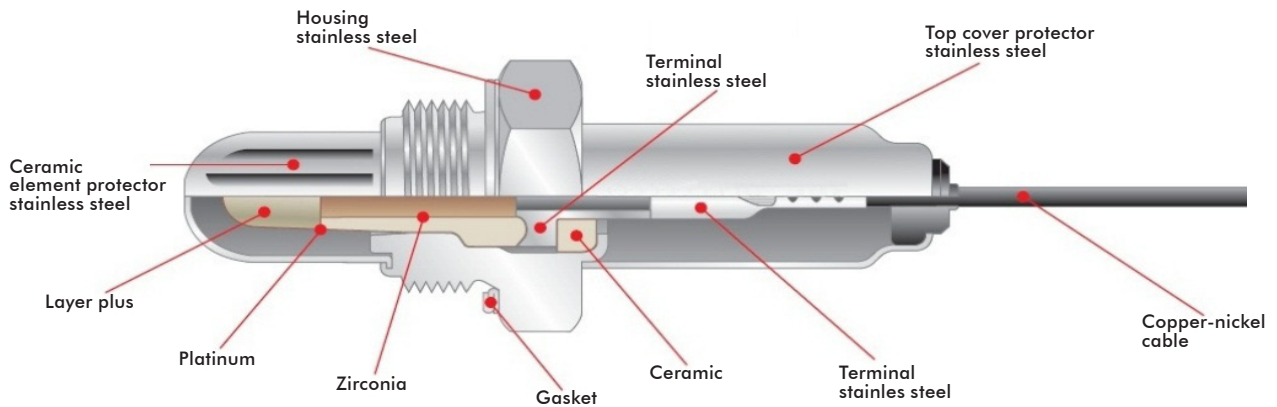

## Installation point of oxygen sensor

Every new car since the institution of the catalytic converter in USA, Sweden, Swiss (1970) and Germany (1985) has an oxygen sensor. It is positioned in the vehicle's exhaust pipe before the catalytic converter, where it measures the oxygen present in the exhaust gases and informs the ECU (engine control unit) to calculate what adjustments are needed to the air/fuel mixture. The exact location of the oxygen sensor varies according to whether the vehicle has a V-type or In-line type exhaust system and depending on brand and model.

Many recently produced vehicles feature a second oxygen sensor mounted after the catalytic converter (diagnostic oxygen sensor). The pre-cat oxygen sensor is the control sensor, assisting the engine ECU to control the air/fuel ratio. The diagnostic sensor is monitoring the function of the catalytic converter.

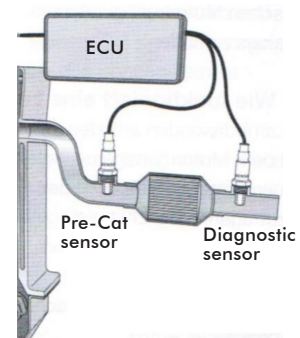



# Oxygen sensor | Installation

## Universal

### Required tooling:

- cable cutter
- cable stripper
- ratchet crimping tool for insulated terminals
- hot air gun
- thread cleaning tap (M18x1,5 -> for most sensors)
- torque wrench with suitable oxygen sensor driver size 22

1. Cut the new sensor cables to length, the new sensor with the old connector must be the same length as the old sensor and connector originally.
2. Cut the old sensor cables to length.
3. Strip the cable ends to a length of 7 mm.
4. Crimp the butt-splices.
5. Shrink the insulation of the butt-splices with hot air, until they are sealed.
6. If needed, clean the thread in the exhaust pipe with the cleaning tap.
7. Apply some of the copper grease on the sensor thread.
8. Tighten the sensor to the correct torque, using the torque wrench. Take care not to damage the cables.



## Direct Fit

### Required tooling:



- thread cleaning tap (M18x1,5 -> for most sensors)
- torque wrench with suitable oxygen sensor driver size 22

1. clean the thread in the exhaust pip with the cleaning tap.
2. Apply some of the copper grease on the sensor thread.
3. Tighten the sensor to the correct torque, using the torque wrench. Take care not to damage the cables.



## Legend

Output signal: black  
 Negative: grey  
 Power heater 12V: white (+/-)

 oxygen sensor  
 heater resistor

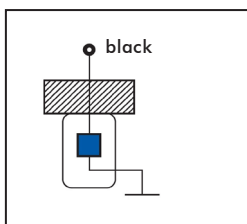

1 cable

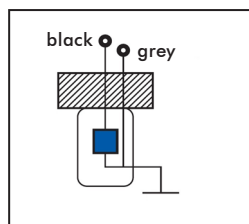

2 cables

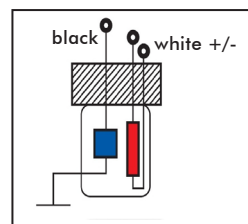

3 cables

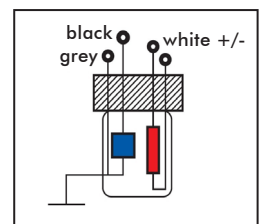

4 cables

Typ Type	Motornummer Engine-No.	Jahr Year	Liter Litre	Zyl. Cyl.	KW	BBT-Nr. BBT-No.
-------------	---------------------------	--------------	----------------	--------------	----	--------------------

<b>Alfa Romeo</b>						
75 1.6 Kat.	AR 61101	05.89 - 02.92	1,6	4	85	OXY321.090
145 1.4 i.e. 16V T.S.	AR 33503, AR 38501	12.96 - 02.99	1,4	4	76	OXY423.097
145 1.7 i.e. 16V	AR 33401	10.94 - 11.96	1,7	4	95	OXY423.097
145 1.8 i.e. 16V T.S.	AR 67106	12.96 - 04.98	1,8	4	103	OXY423.097
145 2.0 16V T.S.	AR 67204	10.95 - 01.01	2,0	4	110	OXY423.097
146 1.4 i.e. 16V T.S.	AR 33503	11.96 - 02.99	1,4	4	76	OXY423.097
146 1.7 i.e.	AR 33401	12.94 - 11.96	1,7	4	95	OXY423.097
146 2.0 16V T.S.	AR 67204	10.95 - 01.01	2,0	4	110	OXY423.097
155 1.7 16V T.S.	AR 67204	05.96 - 12.97	1,7	4	103	OXY423.097
155 2.0 16V T.S.	AR 67106	03.95 - 12.97	2,0	4	110	OXY423.097
155 2.5 TD	VM 07B, VM 31B	04.93 - 12.97	2,5	6	92	OXY321.071
155 2.5 V6	AR 67301	02.92 - 04.96	2,5	6	121	OXY422.088
155 2.5 V6	AR 67302, AR 67303	05.96 - 10.97	2,5	6	120	OXY422.088
164 2.0 T.S.	AR 64103	12.93 - 09.98	2,0	6	106	OXY422.088
164 3.0 24V Q4	AR 64304	12.93 - 09.98	3,0	6	171	OXY422.088
164 3.0 24V Q4	AR 64307, AR 64308	02.94 - 09.98	3,0	6	170	OXY422.088
145 1.4 i.e. 16V T.S.	AR 33503, AR 38501	02.99 - 12.00	1,4	4	76	OXY425.117
145 1.6 i.e. 16V T.S.	AR 67601	02.99 - 12.00	1,6	4	88	OXY425.117
145 1.8 i.e. 16V	AR 32201	05.98 - 12.00	1,8	4	106	OXY425.117
145 2.0 16V Quadrifoglio	AR 32301	05.98 - 12.00	2,0	4	114	OXY425.117
146 1.4 i.e. 16V T.S.	AR 33501, AR 38501	02.99 - 12.00	1,4	4	76	OXY425.117
156 1.6 16V T.S.	AR 32102	04.98 - 09.00	1,6	4	88	OXY425.117
156 1.8 16V T.S.	AR 32201	12.97 - 09.00	1,8	4	106	OXY425.117
156 2.5 V6 24V T.S.	AR 32401	10.97 - 09.00	2,0	6	140	OXY425.117
166 2.0 T.S.	AR 34103	10.98 - 05.00	2,0	4	114	OXY425.117
166 2.0 V6	AR 34102	10.98 - 12.04	2,0	6	151	OXY425.117
166 2.5 V6 24V	AR 34201	10.98 - 09.00	2,5	6	140	OXY425.117
166 3.0 V6 24V	AR 34301	10.98 - 09.00	3,0	6	166	OXY425.117
GTV 1.8 16V	AR 32201	05.98 - 12.00	1,8	4	106	OXY425.117
GTV 2.0 16V T.S.	AR 34102	10.98 - 12.04	2,0	4	110	OXY425.117
GTV 3.0 V6 24V	AR 16102	11.99 - 07.00	3,0	6	162	OXY425.117
Spider 1.8 16V	AR 32201	05.98 - 07.00	1,8	4	106	OXY425.117
Spider 2.0 16V T.S.	AR 16102, AR 32310	06.95 - 04.05	2,0	4	110	OXY425.117
Spider 3.0 V6	AR 16105	10.00 - 03.03	3,0	6	160	OXY425.117

<b>Audi</b>						
80 1.6 E	ADA	06.93 - 12.94	1,6	4	74	OXY321.090
80 1.8 CC quattro	JN	08.85 - 08.86	1,8	4	68	OXY321.090
80 1.8 GTE quattro	PV	03.85 - 08.86	1,8	4	81	OXY321.090
80 2.0 E	ABK	09.91 - 12.94	2,0	4	85	OXY321.090
80 2.0 E quattro	ACE	08.92 - 12.94	2,0	4	103	OXY321.090
80 S2 quattro	ABY	02.93 - 12.94	2,2	5	169	OXY321.090
90 2.0	SK	03.86 - 03.87	2,0	5	83	OXY102.047
90 2.2	KX	01.85 - 03.87	2,2	5	85	OXY102.047
90 2.2 E quattro	JT	08.85 - 03.87	2,2	5	88	OXY321.090
90 2.3 E 20V	7A	08.88 - 07.91	2,3	5	125	OXY321.090
100 2.0 Kat.	RT	01.88 - 11.90	2,0	5	85	OXY321.090
100 2.2	KZ	10.84 - 09.86	2,2	5	85	OXY102.047
100 2.2 E quattro	PX	08.85 - 07.86	2,2	5	88	OXY321.090
100 2.2 Turbo	MC	08.86 - 11.90	2,2	5	121	OXY321.090
100 S4 Turbo quattro	AAN	08.91 - 06.94	2,2	5	169	OXY321.090
A3 1.6	AEH	08.97 - 07.98	1,6	4	74	OXY451.050
A3 1.6	AKL, APF	09.96 - 08.00	1,6	4	74	OXY452.120
A3 1.8	AGN	09.96 - 05.97	1,8	4	92	OXY451.072
A3 1.8	AGN	06.97 - 05.03	1,8	4	74	OXY451.072
A3 1.8 T	AGU	08.97 - 06.03	1,8	4	110	OXY451.072
A3 1.8 T	AJQ, APP, ARY, AUC	12.98 - 05.03	1,8	4	132	OXY452.120
A3 1.8 TFSI	BZB, CDAA, BYT	11.06 - 08.12	1,8	4	118	OXY474.080

Typ Type	Motornummer Engine-No.	Jahr Year	Liter Litre	Zyl. Cyl.	KW	BBT-Nr. BBT-No.
A3 1.8 TFSI quattro	CDAА	07.08 - 08.12	1,8	4	118	OXY474.080
A3 2.0 TFSI	BWA, АХХ, ССЗА, САWB	09.04 - 08.12	2,0	4	147	OXY474.080
A3 2.0 TFSI quattro	BWA, АХХ, ССЗА, ССТА	09.04 - 08.12	2,0	4	147	OXY474.080
A3 2.0 TFSI quattro	CDLH	03.12 ->	2,0	4	188	OXY474.080
A3 Cabriolet 1.8 TFSI	BZB, CDAА	04.08 ->	1,8	4	118	OXY474.080
A3 Cabriolet 2.0 TFSI	CCZA, CAWB	04.08 ->	2,0	4	147	OXY474.080
A3 S3 quattro	AMK, APY	03.99 - 04.02	1,8	4	154	OXY452.031
A3 S3 quattro	BHZ, CDLA	11.06 - 08.12	2,0	4	195	OXY474.080
A3 Sportback 1.8 TFSI	BZB, CDAА, BYT	11.06 ->	1,8	4	118	OXY474.080
A3 Sportback 1.8 TFSI quattro	CDAА	07.08 ->	1,8	4	118	OXY474.080
A3 Sportback 2.0 TFSI	BWA, BPY, АХХ, ССЗА, СBFА, CAWB	09.04 ->	2,0	4	147	OXY474.080
A3 Sportback 2.0 TFSI quattro	BWA, BPY, АХХ, ССЗА	09.04 ->	2,0	4	147	OXY474.080
A3 Sportback RS3 quattro	CEPA	01.11 ->	2,5	5	250	OXY474.080
A4 1.6	ADP, АHL, АNА, АRМ	01.95 - 07.00	1,6	4	74	OXY415.100
A4 1.8	ADR	01.95 - 12.98	1,8	4	92	OXY415.100
A4 1.8 quattro	ADR, АPT, АRГ, АVV	01.95 - 11.00	1,8	4	92	OXY452.120
A4 1.8 T	AEB, ANB, АPU, АRW, АWT	01.95 - 11.00	1,8	4	110	OXY452.120
A4 1.8 TFSI	CABA, CDHA	01.08 ->	1,8	4	88	OXY474.080
A4 1.8 TFSI	CDHB	05.09 ->	1,8	4	118	OXY474.080
A4 1.8 TFSI	CDHB, CABB	11.07 ->	1,8	4	118	OXY474.080
A4 1.8 TFSI quattro	CDHB	09.08 ->	1,8	4	118	OXY474.080
A4 2.0 TFSI	CAEB, CDNC	06.08 ->	2,0	4	155	OXY474.080
A4 2.0 TFSI	CDNB, CFKA, CAEA	06.08 ->	2,0	4	132	OXY474.080
A4 2.0 TFSI flexible fuel	CFKA	11.09 ->	2,0	4	132	OXY474.080
A4 2.0 TFSI flexible fuel quattro	CFKA	11.09 ->	2,0	4	132	OXY474.080
A4 2.0 TFSI quattro	CAEB, CPMA, CDNC	06.08 ->	2,0	4	155	OXY474.080
A5 1.8 TFSI	CABD, CJEB	10.07 ->	1,8	4	125	OXY474.080
A5 2.0 TFSI	CDNB	11.08 ->	2,0	4	132	OXY474.080
A5 2.0 TFSI	CDNC	06.08 ->	2,0	4	155	OXY474.080
A5 2.0 TFSI quattro	CAEB, CDNC	06.08 ->	2,0	4	155	OXY474.080
A5 Cabriolet 1.8 TFSI	CDHB	09.09 ->	1,8	4	118	OXY474.080
A5 Cabriolet 2.0 TFSI	CAEB, CDNC	03.09 ->	2,0	4	155	OXY474.080
A5 Cabriolet 2.0 TFSI	CDNB, CAEA	03.09 ->	2,0	4	132	OXY474.080
A5 Cabriolet 2.0 TFSI quattro	CAEB, CDNC	03.09 ->	2,0	4	155	OXY474.080
A5 Sportback 1.8 TFSI	CDHB	11.09 ->	1,8	4	118	OXY474.080
A5 Sportback 2.0 TFSI	CDNB	09.09 ->	2,0	4	132	OXY474.080
A5 Sportback 2.0 TFSI	CDNC	09.09 ->	2,0	4	155	OXY474.080
A5 Sportback 2.0 TFSI quattro	CDNC	09.09 ->	2,0	4	155	OXY474.080
A6 1.8	ADR	12.95 - 10.97	1,8	4	92	OXY415.057
A6 1.8	AJP	12.97 - 10.98	1,8	4	92	OXY415.100
A6 1.8	AJP, AQE, ARH	07.97 - 01.05	1,8	4	92	OXY452.120
A6 1.8 T quattro	AEB, ANB, АPU, АRW, АWT	02.97 - 01.05	1,8	4	110	OXY452.120
A6 2.0	ABK	06.94 - 10.97	2,0	4	85	OXY321.090
A6 2.0 16V	ACE	06.94 - 10.97	2,0	4	103	OXY321.090
A6 2.0 16V quattro	ACE	06.94 - 10.97	2,0	4	103	OXY321.090
A6 2.0 TFSI	CAEB	03.11 - 05.13	2,0	4	155	OXY474.080
A6 2.0 TFSI	CDNB	05.11 ->	2,0	4	132	OXY474.080
A6 2.0 TFSI hybrid	CHJA	11.11 ->	2,0	4	155	OXY474.080
A6 2.0 TFSI hybrid	CHJA	02.12 ->	2,0	4	155	OXY474.080
A6 2.0 TFSI quattro	CAEB	05.12 - 05.13	2,0	4	155	OXY474.080
A6 2.4	APC	02.97 - 10.05	2,4	6	115	OXY415.057
A6 2.8	ACK, ALG, АМХ, АРР, АQD	02.97 - 01.05	2,8	6	142	OXY415.057
A6 2.8	AGE	10.97 - 07.98	2,8	6	132	OXY415.057
A6 3.0 quattro	BBY	05.04 - 05.06	3,0	6	160	OXY452.082
A6 4.2 quattro	BAT	05.04 - 05.06	4,2	8	246	OXY452.082
A8 2.8	AAH	03.94 - 03.96	2,8	6	128	OXY321.071
A8 2.8 quattro	AAH	03.94 - 03.96	2,8	6	128	OXY321.071
A8 3.7 quattro	AEW	10.95 - 11.98	3,7	8	169	OXY415.087
A8 3.7 quattro	AEW, AKJ	07.95 - 11.98	3,7	8	169	OXY453.042

Typ Type	Motornummer Engine-No.	Jahr Year	Liter Litre	Zyl. Cyl.	KW	BBT-Nr. BBT-No.
A8 3.7 quattro	AKC, AQG	11.98 - 09.02	3,7	8	191	OXY453.042
A8 4.2 quattro	ABZ, AKG	03.94 - 11.98	4,2	8	220	OXY453.042
A8 4.2 quattro	AQF, AUW, AUX	11.98 - 09.02	4,2	8	228	OXY453.042
A8 4.2 quattro	ARU	02.99 - 04.00	4,2	8	175	OXY453.042
A8 S8 quattro	AHC, AKH	09.96 - 12.98	4,2	8	250	OXY415.087
A8 S8 quattro	AQH, AVP	06.99 - 09.02	4,2	8	265	OXY453.042
Coupe 1.8 GT	JN	01.85 - 07.88	1,8	4	68	OXY102.047
Coupe 2.2 GT	KX	07.81 - 10.87	2,2	5	85	OXY102.047
Q3 2.0 TFSI quattro	CCZC	06.11 ->	2,0	4	125	OXY474.080
Q3 2.0 TFSI quattro	CPSA	06.11 ->	2,0	4	155	OXY474.080
Q5 2.0 TFSI hybrid quattro	CHJA	06.11 ->	2,0	4	155	OXY474.080
Q5 2.0 TFSI quattro	CAEB, CPMA, CDNC	11.08 ->	2,0	4	155	OXY474.080
Q5 2.0 TFSI quattro	CDNB, CNCB	08.09 ->	2,0	4	132	OXY474.080
Q5 2.0 TFSI quattro	CPMB	05.13 ->	2,0	4	162	OXY474.080
Quattro 2.2 20V	RR	08.89 - 07.91	2,2	5	162	OXY321.090
TT 1.8 T	AJQ, APP, ARY, AUQ	10.98 - 06.06	1,8	4	132	OXY452.120
TT 1.8 T	AUM	09.02 - 06.06	1,8	4	110	OXY452.120
TT 1.8 T	BVP	09.05 - 06.06	1,8	4	120	OXY452.120
TT 1.8 T	BVR	09.05 - 06.06	1,8	4	140	OXY452.120
TT 1.8 T quattro	AJQ, ARY	10.98 - 06.06	1,8	4	132	OXY452.120
TT 1.8 T quattro	AÜX, BAM	10.98 - 06.06	1,8	4	165	OXY452.031
TT 2.5 TFSI RS quattro	CEPA	07.09 ->	2,5	5	250	OXY474.080
TT 2.5 TFSI RS quattro	CEPB	05.11 ->	2,5	5	265	OXY474.080
TT Roadster 2.5 TFSI RS quattro	CEPA	07.09 ->	2,5	5	250	OXY474.080
TT Roadster 2.5 TFSI RS quattro	CEPB	03.12 ->	2,5	5	265	OXY474.080

## BMW

316 i (E30)	M40 B16	09.88 - 12.91	1,6	4	73	OXY427.084
316 i (E36)	M40 B16	12.90 - 02.94	1,6	4	75	OXY427.055
316 i (E36)	M43 B16	09.93 - 09.95	1,6	4	75	OXY427.055
316 i Compact (E36)	M43 B16	03.94 - 09.95	1,6	4	75	OXY427.055
316 i Coupe (E36)	M43 B16	09.93 - 09.95	1,6	4	75	OXY427.055
316 i Touring (E30)	M40 B16	09.91 - 06.94	1,6	4	73	OXY427.084
318 i (E30)	M40 B18	09.87 - 04.94	1,8	4	83	OXY427.084
318 i (E36)	M40 B18	12.90 - 02.94	1,8	4	85	OXY427.055
318 i (E36)	M43 B18	03.93 - 09.95	1,8	4	85	OXY427.055
318 i Cabriolet (E36)	M43 B18	01.94 - 09.95	1,8	4	85	OXY427.055
318 i Touring (E30)	M40 B18	04.89 - 04.94	1,8	4	83	OXY427.084
318 i Touring (E36)	M43 B18	07.95 - 09.95	1,8	4	85	OXY427.055
318 iS (E30)	M42 B18	09.89 - 08.90	1,8	4	100	OXY427.084
318 iS (E30)	M42 B18	09.90 - 12.93	1,8	4	100	OXY427.084
318 iS (E36)	M42 B18	09.93 - 12.96	1,8	4	103	OXY427.055
318 iS Coupe (E36)	M42 B18	03.92 - 12.96	1,8	4	103	OXY427.055
318 ti Compact (E36)	M42 B18	10.94 - 12.96	1,8	4	103	OXY427.055
320 Ci Cabriolet (E46)	M54 B22, M54 226S1	09.00 ->	2,2	6	125	OXY458.034
320 i (E30)	M20 B20	10.87 - 12.93	2,0	6	95	OXY427.055
320 i (E36)	M50 B20	09.90 - 08.92	2,0	6	110	OXY427.055
320 i (E46)	M52 B20	03.98 - 09.00	2,0	6	110	OXY458.034
320 i (E46)	M54 B22, M54 226S1	09.00 - 02.05	2,2	6	125	OXY458.034
320 i Coupe (E36)	M50 B20	03.92 - 08.92	2,0	6	110	OXY427.055
320 i Touring (E30)	M20 B20	01.88 - 12.93	2,0	6	90	OXY427.055
323 Ci Cabriolet (E46)	M52 B25 Vanos	04.00 - 09.00	2,5	6	125	OXY458.034
323 i (E46)	M52 B25 TU, M52 B25 Vanos	03.98 - 09.00	2,5	6	125	OXY458.034
325 e (E30)	M20 B27	10.87 - 12.93	2,7	6	95	OXY427.055
325 e (E30)	M20 B27	09.87 - 09.90	2,7	6	95	OXY427.084
325 i (E30)	M20 B25	10.87 - 12.93	2,5	6	125	OXY427.055
325 i (E36)	M50 B25	09.90 - 12.95	2,5	6	141	OXY427.055
325 i (E46)	M54 B25, M54 256S5	09.00 - 02.05	2,5	6	141	OXY458.034
325 i Cabriolet (E36)	M50 B25	03.93 - 12.95	2,5	6	141	OXY427.055

Typ Type	Motornummer Engine-No.	Jahr Year	Liter Litre	Zyl. Cyl.	KW	BBT-Nr. BBT-No.
325 i Coupe (E36)	M50 B25	03.92 - 12.95	2,5	6	141	OXY427.055
325 i Touring (E30)	M20 B25	10.87 - 12.93	2,5	6	125	OXY427.055
325 iX (E30)	M20 B25	10.87 - 12.93	2,5	6	125	OXY427.055
325 iX Touring (E30)	M20 B25	06.88 - 12.93	2,5	6	125	OXY427.055
325 ti (E46)	M54 B25, M54 256S5	06.01 - 02.05	2,5	6	141	OXY458.034
325 xi (E46)	M54 256S5	09.00 - 02.05	2,5	6	141	OXY458.034
328 i (E46)	M52 B28	02.98 - 06.00	2,8	6	142	OXY458.034
330 i (E46)	M54 B30, M54 306S3	06.00 - 02.05	3,0	6	170	OXY458.034
330 xi (E46)	M54 306S3	06.00 - 02.05	3,0	6	170	OXY458.034
518 g Touring	M43 B18	11.95 - 06.96	1,8	4	85	OXY427.084
518 i (E34)	M40 B18	09.89 - 12.95	1,8	4	85	OXY427.084
518 i (E34)	M43 B18	12.93 - 12.95	1,8	4	85	OXY427.084
518 i Touring (E34)	M40 B18	03.93 - 12.94	1,8	4	83	OXY427.084
518 i Touring (E34)	M43 B18	12.93 - 12.96	1,8	4	85	OXY427.084
520 i (E34)	M50 B20	09.89 - 06.92	2,0	6	110	OXY427.150
520 i (E39)	M52 B (20 6S3) Vanos	04.99 - 06.03	2,0	6	100	OXY458.034
520 i (E39)	M54 B22	09.00 - 06.03	2,2	6	125	OXY458.034
520 i (E60)	M54 B22, M54 226S1	07.03 - 03.10	2,2	6	125	OXY458.034
520 i Touring (E34)	M50 B20	11.91 - 06.92	2,0	6	110	OXY427.150
523 i (E39)	M52 B25 TU, M52 B25 Vanos	11.95 - 09.00	2,5	6	125	OXY458.034
525 e (E28)	M20 B27	12.84 - 11.86	2,7	6	95	OXY102.047
525 i (E34)	M50 B25	09.89 - 12.95	2,5	6	141	OXY427.150
525 i (E39)	M54 B25, M54 256S5	09.00 - 06.03	2,5	6	141	OXY458.034
525 i (E60)	M54 B25, M54 256S5	09.03 - 03.10	2,5	6	170	OXY458.034
525 i Touring (E34)	M50 B25	11.91 - 12.95	2,5	6	141	OXY427.150
525 i Touring (E61)	M54 B25, M54 256S5	06.04 - 03.10	2,5	6	141	OXY458.034
525 iX (E34)	M50 B25	09.91 - 12.95	2,5	6	141	OXY427.150
525 iX Touring (E34)	M50 B25	02.92 - 12.96	2,5	6	141	OXY427.150
528 i (E39)	M52 B28, M52 B28 TU	11.95 - 09.00	2,8	6	142	OXY458.034
530 i (E34)	M30 B30	01.88 - 12.90	3,0	6	138	OXY427.150
530 i (E34)	M60 B30	09.92 - 06.94	3,0	8	160	OXY427.055
530 i (E39)	M54 B30, M54 306S3	09.00 - 06.03	3,0	6	170	OXY458.034
530 i (E60)	M54 B30, M54 306S3	07.03 - 03.10	3,0	6	170	OXY458.034
530 i Touring (E34)	M60 B30	09.92 - 06.94	3,0	8	160	OXY427.055
535 i (E34)	M30 B35	01.88 - 12.93	3,5	6	155	OXY427.150
535 i (E39)	M62 B (35 8 S1), M62 B35	04.96 - 03.99	3,5	8	173	OXY458.034
535 i (E39)	M62 B (35 8 S2), M62 B35 TU	04.99 - 06.03	3,5	8	180	OXY458.034
540 i (E34)	M60 B40	09.92 - 06.94	4,0	8	210	OXY427.055
540 i (E39)	M62 B44, M62 B44 TU	04.96 - 06.03	4,4	8	210	OXY458.034
540 i Touring (E34)	M60 B40	10.93 - 06.94	4,0	8	210	OXY427.055
728 i,iL (E38)	M52 B28, M52 B28 TU	08.95 - 11.01	2,8	6	142	OXY458.034
730 i (E32)	M30 B30	10.87 - 06.94	3,0	6	145	OXY427.150
730 i V8 (E32)	M60 B30	09.91 - 10.94	3,0	8	160	OXY427.055
730 i, Li (E65, E66)	M54 B30, M54 306S3	03.03 - 03.10	3,0	6	170	OXY458.034
735 i (E32)	M30 B35	10.87 - 12.92	3,4	6	155	OXY427.150
735 i,iL (E38)	M62 B (35 8 S1), M62 B35	01.96 - 11.01	3,5	8	173	OXY458.034
740 i (E32)	M60 B40	09.91 - 10.94	4,0	8	210	OXY427.055
740 i,iL (E38)	M62 B44, M62 B44 TU	01.96 - 11.01	4,4	8	210	OXY458.034
750 i (E32)	M70 B50	09.87 - 10.94	5,0	12	220	OXY427.055
750 i,iL (E38)	M73 B54	12.94 - 11.01	5,4	12	240	OXY458.034
840 Ci (E31)	M60 B40	04.93 - 03.96	4,0	8	210	OXY427.055
850 Ci (E31)	M73 B54	09.94 - 12.99	5,4	12	240	OXY458.034
850 CSI (E31)	M70 B56	08.92 - 10.96	5,6	12	280	OXY427.055
850 CSI (E31)	M70 B56	08.92 - 10.96	5,6	12	280	OXY427.084
M3 (E36)	S50 B30	01.94 - 09.95	3,0	6	210	OXY427.055
M3 Coupe (E36)	S50 B30	09.92 - 09.95	3,0	6	210	OXY427.055
M5 (E39)	S38 B49, S62 B50	10.98 - 06.03	5,0	8	294	OXY458.034
X3 3.0 i (E83)	M54 B30, M54 306S3	01.04 ->	3,0	6	170	OXY458.034
X5 3.0 i (E53)	M54 306S3	05.00 ->	3,0	6	163	OXY458.034

Typ Type	Motornummer Engine-No.	Jahr Year	Liter Litre	Zyl. Cyl.	KW	BBT-Nr. BBT-No.
X5 3.0 i (E53)	M54 B30, M54 306S3	05.00 ->	3,0	6	170	OXY458.034
X5 4.4 i (E53)	M62 B44, M62 B44 TU	05.00 ->	4,4	8	210	OXY458.034
X5 4.6 is (E53)	M62 B46, M67 468S1	02.02 ->	4,6	8	255	OXY458.034
Z1 2.5	M20 B25	07.88 - 06.91	2,5	6	125	OXY427.055
Z3 2.0	M52 B (20 6S4), M52 B20	04.99 - 01.03	2,0	6	110	OXY458.034
Z3 2.2	M54 B22, M54 226S1	08.00 - 01.03	2,2	6	125	OXY458.034
Z3 2.8	M52 B28, M52 B28 TU	04.97 - 06.00	2,8	6	141	OXY458.034
Z3 3.0	M54 B30, M54 306S3	06.00 - 01.03	3,0	6	170	OXY458.034
Z4 2.2 i (E85)	M54 B22, M54 226S1	10.03 ->	2,2	6	125	OXY458.034
Z4 2.5 i (E85)	M54 B22, M54 256S5	02.03 ->	2,5	6	141	OXY458.034
Z4 3.0 i (E85)	M54 B30, M54 306S3	02.03 ->	3,0	6	170	OXY458.034
Z8 4.9	S38 B49, S62 B50	06.00 - 06.03	4,9	8	294	OXY458.034
<b>Citroën</b>						
AX 1.1	HB1, HDZ (TU1M)	09.86 - 12.97	1,1	4	44	OXY418.120
AX 1.4	KDX (TU3M/Z), KDZ (TU3M/Z)	04.87 - 12.97	1,4	4	55	OXY418.120
AX 1.4 GTi	KFX (TU3FJ2)	06.91 - 12.96	1,4	4	69	OXY418.045
AX 1.4 GTi	KFY (TU3FJ2)	08.91 - 12.96	1,4	4	66	OXY418.045
AX 1.4 GTi	KFZ (TU3FJ2)	06.91 - 12.92	1,4	4	74	OXY418.045
Berlingo 1.1 i	HDX (TU1M), HFX (TU1JP)	07.96 ->	1,1	4	44	OXY459.057
Berlingo 1.1 i	HDZ (TU1M)	07.96 - 11.02	1,1	4	44	OXY420.037
Berlingo 1.4 i	KFX (TU3JP)	07.96 - 06.98	1,4	4	55	OXY420.037
Berlingo 1.8 i	LFX (XU7JB)	05.97 ->	1,8	4	66	OXY420.063
Berlingo 1.6 16V	NFU (TU5JP4)	10.00 ->	1,6	4	80	OXY459.057
C2 1.1	HFX (TU1JP)	09.03 ->	1,1	4	44	OXY459.057
C2 1.6	NFU (TU5JP4)	09.03 ->	1,6	4	80	OXY459.057
C2 1.6 VTS	NFS (TU1JP)	01.05 ->	1,6	4	90	OXY459.057
C3 1.1 i	HFX (TU1JP)	02.02 ->	1,1	4	44	OXY459.057
C3 Pluriel 1.6	NFU (TU5JP4)	05.03 ->	1,6	4	80	OXY459.057
C4 1.6 16V	NFU (TU5JP4)	11.04 ->	1,6	4	80	OXY459.057
C4 2.0 16V	RFN (EW10J4)	11.04 ->	2,0	4	100	OXY459.057
C5 1.8 16V	6FZ (EW7J4)	03.01 - 08.04	1,8	4	85	OXY420.055
C5 1.8 16V	GFZ (EW7J4)	09.04 ->	1,8	4	85	OXY459.057
C5 2.0 16V	RFN (EW10J4)	03.01 - 08.04	2,0	4	100	OXY459.057
C5 3.0 V6	XFU (ES9A)	02.08 ->	3,0	6	155	OXY459.057
C5 3.0 V6	XFV (ES9A), XFX (ESJ4S)	09.04 ->	3,0	6	152	OXY459.057
C5 3.0 V6	XFX (ES9J4S)	03.01 - 08.04	3,0	6	152	OXY459.057
C6 3.0 V6	ES9J4S, XFV (ES9A)	09.05 ->	3,0	6	155	OXY459.057
C8 3.0 V6	XFX (ES9J4S)	07.02 ->	3,0	6	150	OXY459.057
Jumper 2.0	RFW (XU10J2U)	02.94 - 04.02	2,0	4	80	OXY459.057
Jumper 2.0	RFW (XU10J2U)	02.94 - 02.02	2,0	4	80	OXY418.150
Saxo 1.0 X	CDZ (TU9M)	05.98 - 06.03	1,0	4	37	OXY420.037
Saxo 1.1 X, SX	HDY (TU1M)	05.96 - 09.03	1,1	4	40	OXY420.037
Saxo 1.1 X, SX	HDZ (TU1M)	05.96 - 09.03	1,1	4	40	OXY459.057
Saxo 1.1 X, SX -> EURO 93	HDZ (TU1M)	05.96 - 09.03	1,1	4	44	OXY420.037
Saxo 1.1 X, SX	HFX (TU1JP)	05.96 - 09.03	1,1	4	44	OXY459.057
Saxo 1.4 VTS	KFW (TU3JP), KFX (TU3JP)	05.96 - 06.03	1,4	4	55	OXY459.057
Saxo 1.4 VTS	KFX (TU3JP)	01.98 - 06.03	1,4	4	55	OXY420.037
Xantia 1.6 i	BFZ (XU5JP)	03.93 - 01.98	1,6	4	65	OXY418.045
Xantia 1.8 i	LFZ (XU7JP)	03.93 - 01.98	1,8	4	74	OXY418.045
Xantia 1.8 i	LFX (XU7JB)	04.97 - 01.98	1,8	4	66	OXY420.063
Xantia 2.0 i	RFX (XU10J2C)	03.93 - 01.98	2,0	4	89	OXY418.045
Xantia 2.0 i 16V	RFT (XU10J4/Z)	06.94 - 01.98	2,0	4	110	OXY418.150
Xantia 2.0 i 16V	RFY (XU10J4/Z)	03.93 - 01.98	2,0	4	112	OXY418.150
XM 2.0	R6A	05.89 - 06.94	2,0	4	94	OXY418.150
XM 2.0 i	RDZ (XU10MZ)	05.89 - 09.94	2,0	4	79	OXY418.150
XM 2.0 i	RFZ (XU10J2)	05.89 - 06.94	2,0	4	89	OXY418.150
XM 2.0 i Turbo	RGX (XU10J2TE/Z)	09.92 - 06.94	2,0	4	104	OXY418.150
Xsara 1.4 i	KFW (TU3JP), KFX (TU3JP)	04.97 - 03.05	1,4	4	55	OXY420.055

Typ Type	Motornummer Engine-No.	Jahr Year	Liter Litre	Zyl. Cyl.	KW	BBT-Nr. BBT-No.
Xsara 1.8 i	LFX (XU7JB)	04.97 - 09.00	1,8	4	66	OXY420.063
Xsara 2.0 16V	RFN (EW10J4)	09.00 - 03.05	2,0	4	100	OXY459.057
Xsara Picasso 1.6 16V	NFU (TU5JP4)	09.05 ->	1,6	4	80	OXY459.057
Xsara Picasso 2.0 16V	RFN (EW10J4)	01.03 ->	2,0	4	100	OXY459.057
ZX 1.1	HDZ (TU1M)	03.91 - 06.97	1,1	4	44	OXY418.150
ZX 1.4 i	KDX (TU3M/Z), KDZ (TU3M/Z), KFX (TU3JP)	03.91 - 06.97	1,4	4	55	OXY418.150
ZX 1.4 i	KFX (TU3M/Z), KDX (TU3M/Z), KFX (TU3JP)	03.91 - 06.97	1,4	4	55	OXY418.045
ZX 1.6 i	BDY (XU5M), BFZ (XU5JP)	03.91 - 06.97	1,6	4	65	OXY418.150
ZX 1.8 i	LFZ (XU7JP)	07.92 - 06.97	1,8	4	74	OXY418.150
ZX 1.9	DGE (XU9JA)	03.91 - 06.97	1,9	4	93	OXY418.150
ZX 1.9 i	DKZ (XU9JA)	03.91 - 06.97	1,9	4	88	OXY418.150
ZX 2.0	---	07.94 - 10.97	2,0	4	90	OXY418.150
ZX 2.0 i	RFX (XU10J2C)	07.92 - 06.97	2,0	4	89	OXY418.150
<b>Daewoo</b>						
Espero 1.5 16V	A15MF	02.95 - 06.99	1,5	4	66	OXY101.040
Espero 1.5 16V	---	10.93 - 09.94	1,5	4	65	OXY101.040
Espero 1.8	C118LE	02.95 - 06.99	1,8	4	70	OXY101.040
Espero 1.8	C118LE	02.95 - 09.99	1,8	4	66	OXY101.040
Espero 2.0	---	10.93 - 09.94	2,0	4	81	OXY101.040
Espero 2.0	C20LE	02.95 - 06.99	2,0	4	77	OXY101.040
Espero 2.0	C20LZ	10.91 - 09.93	2,0	4	74	OXY101.040
Nexia 1.5	G15MF	08.96 - 08.97	1,5	4	44	OXY101.040
Nexia 1.5	G15MF	02.95 - 08.97	1,5	4	55	OXY101.040
Nexia 1.5	G15MF	02.95 - 08.97	1,5	4	52	OXY101.040
Nexia 1.5 16V	A15MF	02.95 - 08.97	1,5	4	66	OXY101.040
Nubira 2.0 16V	X20SED	05.97 ->	2,0	4	98	OXY101.040
Nubira 1.6 16V	A16DMS	05.97 ->	1,6	4	78	OXY101.040
<b>Ferrari</b>						
348 TB 3.4	F 119 D 040	10.93 - 04.94	3,4	8	235	OXY422.088
348 TB 3.4	F 119 D 040	10.93 - 12.95	3,4	8	235	OXY422.088
348 TB 3.4	F 119 F 000	02.90 - 10.93	3,4	8	221	OXY422.088
348 TB 3.4	F 119 F 000	08.90 - 10.93	3,4	8	221	OXY422.088
512 TR 5.0	F 113 D00/40	01.92 - 10.94	5,0	12	315	OXY422.088
Mondial 3.2 Quattrovalvole	F 105 C..	10.85 - 12.88	3,2	8	199	OXY321.090
Testarossa 5.0	F 113 B..	08.86 - 10.91	5,0	12	272	OXY321.090
<b>Fiat</b>						
Bravo 2.0 HGT 20V	182 A1.000	10.95 - 07.98	2,0	4	108	OXY423.097
Cinquecento 0.9 i.e.	1170 A1.000, 1170 A1.046	10.91 - 03.95	0,9	4	40	OXY422.088
Cinquecento 0.9 i.e.	170 A1.046	10.91 - 12.93	0,9	4	41	OXY422.088
Cinquecento 0.9 i.e. S	170 A1.046	03.95 - 07.99	0,9	4	29	OXY423.097
Doblo 1.2	223 A5.000	03.01 - 01.04	1,2	4	48	OXY425.117
Doblo 1.6 16V	182 B6.000	10.01 - 01.04	1,6	4	76	OXY425.117
Doblo 1.6 Natural Power	182 B6.000	01.03 - 01.04	1,6	4	76	OXY425.117
Ducato 2.0	RFL	04.02 ->	2,0	4	81	OXY459.057
Ducato 2.0	RFW	03.94 - 04.02	2,0	4	80	OXY418.150
Ducato 2.0 Bipower	---	11.02 ->	2,0	4	81	OXY459.057
Fiorino 65 1.7 TD	146 D7.000	01.97 - 05.01	1,7	4	46	OXY321.090
Fiorino 70 1.4 i.e.	146 C5.000, 146 D5.000	06.95 - 05.01	1,4	4	49	OXY423.097
Fiorino 75 1.6 i.e.	146 D6.000	06.95 - 05.01	1,6	4	55	OXY423.097
Marea 2.0 150 20V	182 A1.000	10.96 - 02.99	2,0	4	108	OXY423.097
Panda 1.3 D Multijet	188 A9.000	09.03 ->	1,3	4	51	OXY321.090
Panda 750	141 B.000	01.86 - 01.95	0,8	4	25	OXY321.090
Panda 750	156 A4.000	01.86 - 01.95	0,8	4	25	OXY321.090
Panda 750 Kat.	156 A4.000	01.95 - 12.97	0,8	4	25	OXY321.090
Panda 1000 i.e. Kat.	141 C2.000	01.95 - 08.98	1,0	4	33	OXY423.097
Panda 1000 i.e. Kat.	156 A2.246	07.90 - 03.97	1,0	4	33	OXY422.088

Typ Type	Motornummer Engine-No.	Jahr Year	Liter Litre	Zyl. Cyl.	KW	BBT-Nr. BBT-No.
Panda 1100	156 C.046	01.93 - 03.97	1,1	4	37	OXY422.088
Panda 1100	176 B2.000, 187 A1.000	02.95 - 09.03	1,1	4	40	OXY423.097
Panda Van 1000 i.e.	156 A2.246	08.92 - 02.04	1,0	4	33	OXY321.090
Punto 1.4 GT Turbo	176 A4.000	01.94 - 12.94	1,4	4	98	OXY422.088
Punto 1.4 GT Turbo	176 B6.000	09.96 - 04.97	1,4	4	96	OXY422.088
Punto 55 1.1	176 A6.000	09.93 - 12.94	1,1	4	40	OXY422.088
Punto 55 1.1	176 B2.000	05.97 - 08.99	1,1	4	40	OXY423.097
Punto 60 1.2	176 A7.000	01.94 - 05.94	1,2	4	53	OXY422.088
Punto 60 1.2	176 B1.000, 176 B4.000	06.94 - 04.97	1,2	4	44	OXY422.088
Punto 60 1.2	176 B1.000, 176 B4.000	06.94 - 09.99	1,2	4	44	OXY423.097
Punto 75 1.2	176 A8.000	10.93 - 12.94	1,2	4	54	OXY422.088
Punto 75 1.2	178 A8.000	05.97 - 12.97	1,2	4	54	OXY423.097
Punto Van 1.1	176 B2.000	04.96 - 04.97	1,1	4	40	OXY422.088
Seicento 0.9	1170 A1.046	03.98 - 09.99	0,9	4	29	OXY423.097
Tempra 1.6	159 A3.000	03.90 - 04.93	1,6	4	63	OXY321.090

### Ford

Cougar 2.0 16V	EDBA, EDBB, EDBC, EDBD	08.98 - 12.01	2,0	4	96	OXY413.040
Courier 1.3	J4C	02.96 ->	1,3	4	44	OXY410.040
Fiesta IV 1.3 i	J4C, J4J, J4L, J4Q, J4R, J4T	08.95 - 01.02	1,3	4	44	OXY410.040
Fiesta IV 1.3 i	JJA, JJC, JJE, JJJ, JJK, JJM	08.95 - 01.02	1,3	4	37	OXY410.040
Fiesta IV 1.4 i 16V	FHA, FHE	08.95 - 01.02	1,4	4	44	OXY413.040
Focus 1.4 16V	FXDA, FXDB, FXBC, FXDD	10.98 - 11.04	1,4	4	55	OXY413.040
Focus 1.6 16V	FYDA, FYDB, FYDC, FYDD, FYDH	10.98 - 11.04	1,6	4	74	OXY413.040
Focus 1.8 16V	EYDB, EYDC, EYDD, EYDE, EYDF, EYDG, EYDI	10.98 - 11.04	1,8	4	85	OXY413.040
Focus 2.0 16V	EDDB, EDDC, EDDD, EDDF	10.98 - 11.04	2,0	4	96	OXY413.040
Focus RS	HMDA	10.02 - 11.04	2,0	4	158	OXY413.040
Focus ST170	ALDA	03.02 - 11.04	2,0	4	127	OXY413.040
Fusion 1.4	FXJA, FYJB	08.02 ->	1,4	4	59	OXY413.040
Galaxy 2.8 i V6	AAA, AMY	11.95 - 04.00	2,8	6	128	OXY415.087
Gougar 2.5 V6 24V	LCBA	08.98 - 12.01	2,5	6	125	OXY413.040
Mondeo II 1.6 i	L1J	09.96 - 11.00	1,6	4	66	OXY413.040
Mondeo II 1.6 i 16V	L1L, L1N, L1Q	05.98 - 11.00	1,6	4	70	OXY413.040
Mondeo II 1.8 i	RKB, RKF, RKH, RKJ, RKK	09.96 - 11.00	1,8	4	85	OXY413.040
Mondeo II 2.0 i	NGA, NGB, NGC, NGD	09.96 - 11.00	2,0	4	96	OXY413.040
Mondeo II 2.5 24V	SEA	09.96 - 11.00	2,5	6	125	OXY413.040
Mondeo II 2.5 24V	SEB, SEC	06.00 - 11.00	2,5	6	125	OXY413.040
Mondeo II 2.5 ST200	SGA	05.99 - 11.00	2,5	6	151	OXY413.040
Mondeo III ST220	MEBA	04.02 - 08.07	3,0	6	166	OXY413.040
Scorpio II 2.9 i 24V	BOB	10.94 - 08.98	2,9	6	152	OXY410.040
Tourneo Connect 1.8 16V	EYPA, EYPC	06.02 ->	1,8	4	85	OXY413.040
Transit Connect 1.8 16V	EYPA, EYPC	06.02 ->	1,8	4	85	OXY413.040

### Isuzu

Trooper 3.2	6VD1	08.91 - 07.98	3,2	6	130	OXY356.040
-------------	------	---------------	-----	---	-----	------------

### Honda

Accord IV Aerodeck 2.2 i 16V	F22 A8	01.91 - 12.93	2,2	4	108	OXY333.058
Accord IV Coupe 2.0 i 16V	F20 A7	01.92 - 09.93	2,0	4	98	OXY333.058

### Hyundai

Coupe 2.0	G4GC-G	03.02 - 08.09	2,0	4	102	OXY460.022
Coupe 2.0 GLS	G4GC-G	02.03 - 08.09	2,0	4	105	OXY460.022
Elantra 1.8	G4BB	06.00 - 07.06	1,8	4	97	OXY460.022
Elantra 2.0	G4GC	06.00 - 07.06	2,0	4	104	OXY460.022
Elantra 2.0	G4GC-G	06.00 - 07.06	2,0	4	102	OXY460.022
Elantra 2.0	G4GC	10.03 - 07.06	2,0	4	105	OXY460.022
Matrix 1.8	G4GB-G	06.01 - 08.10	2,0	4	90	OXY460.022
Trajet 2.0	G4GC-G	01.04 - 07.08	2,0	4	103	OXY460.022

Typ Type	Motornummer Engine-No.	Jahr Year	Liter Litre	Zyl. Cyl.	KW	BBT-Nr. BBT-No.
Tucson 2.0	G4GC	08.04 - 03.10	2,0	4	104	OXY460.022
S Coupe 1.5 i	G4EK	04.92 - 05.96	1,5	4	65	OXY321.090
S Coupe 1.5 i	G15B, G4DJ	02.90 - 05.96	1,5	4	62	OXY321.090
S Coupe 1.5 i Turbo	G4EK-TC	04.91 - 05.96	1,5	4	85	OXY321.090
<b>Kia Motors</b>						
Cee'd 2.0	G4GC	09.07 - 03.10	2,0	4	105	OXY460.022
Cerato 2.0	G4GC	04.04 ->	2,0	4	105	OXY460.022
Pro Cee'd 2.0	G4GC	02.08 ->	2,0	4	105	OXY460.022
Sportage 2.0 16V	G4GC	09.04 ->	2,0	4	104	OXY460.022
<b>Lancia</b>						
Dedra 1.8 i.e.	835 C5.000	10.94 - 12.95	1,8	4	66	OXY423.097
Dedra 2.0 i.e. Turbo	835 A8.046	04.91 - 07.99	2,0	4	119	OXY321.090
Dedra 2.0 i.e. Turbo Integrale	835 A7.000	05.90 - 07.94	2,0	4	121	OXY321.090
Dedra SW 1.8 i.e.	836 A5.000	10.94 - 12.95	1,8	4	74	OXY423.097
Delta II 1.4 i.e.	160 A1.046	10.94 - 08.99	1,4	4	51	OXY422.088
Delta II 1.6 i.e.	835 C1.000	06.93 - 12.95	1,6	4	55	OXY422.088
Delta II 1.8 i.e.	835 C2.000	06.93 - 12.94	1,8	4	76	OXY422.088
Delta II 1.8 i.e.	835 C4.000	07.94 - 12.94	1,8	4	66	OXY422.088
Delta II 2.0 16V Turbo	175 A4.000	07.96 - 08.99	2,0	4	142	OXY321.090
Delta II 2.0 16V Turbo	836 A2.000	06.93 - 08.99	2,0	4	137	OXY321.090
Kappa 2.0 16V Turbo	838 A4.000	02.95 - 06.98	2,0	4	151	OXY423.097
Kappa 2.0 20V	838 A1.000	10.94 - 06.96	2,0	5	107	OXY423.097
Kappa 2.0 20V	838 A6.000	07.96 - 06.98	2,0	5	114	OXY423.097
Kappa 2.0 20V Turbo	175 A3.000	06.98 - 12.00	2,0	5	162	OXY423.097
Kappa 2.4 20V	838 A2.000	11.94 - 06.98	2,4	5	129	OXY423.097
Kappa 3.0 24V	838 B.000	11.94 - 10.01	3,0	6	150	OXY425.117
Phedra 3.0 V6	ES994S	09.02 ->	3,0	6	150	OXY459.057
Thema 2000 i.e. 16V	834 C1.246	05.88 - 08.92	2,0	4	108	OXY321.090
Y 1.2	840 A3.000	03.96 - 06.96	1,2	4	44	OXY423.097
Y 1.4 12V	840 A2.000	10.96 - 06.00	1,4	4	59	OXY423.097
Y 1.4 12V	840 A4.000	03.96 - 06.00	1,4	4	55	OXY423.097
Y10 1.1 Acenuc	176 B2.000	01.95 - 12.95	1,1	4	40	OXY422.088
Y10 1.1 i.e. Fire	156 C.046	08.92 - 09.95	1,1	4	37	OXY422.088
<b>Land Rover</b>						
Range Rover III 4.4	---	03.02 - 08.12	4,4	8	210	OXY458.034
<b>Mazda</b>						
3 1.4	ZJ-VE	10.03 - 06.09	1,4	4	62	OXY465.059
3 1.6	Z6	02.04 ->	1,6	4	77	OXY465.059
5 2.0 CD	---	03.05 ->	2,0	4	81	OXY467.088
5 2.0 CD	RF7J	06.05 ->	2,0	4	105	OXY467.088
121 III 1.3	J4R, J4T	03.96 - 04.03	1,3	4	44	OXY410.040
626 IV 1.8 i	---	08.94 - 04.97	1,8	4	66	OXY405.030
626 IV 2.0 i	FS	01.92 - 04.97	2,0	4	85	OXY405.030
626 IV 2.0 i 4WD	FS	04.92 - 04.97	2,0	4	85	OXY405.030
626 V 1.9	FP9A	12.99 - 10.02	1,9	4	74	OXY405.030
626 V Station Wagon 1.9	FP9A	01.00 - 10.02	1,9	4	74	OXY405.030
MX-6 2.0	FS	02.92 - 02.97	2,0	4	85	OXY405.030
Xedos 9 2.0 24V	KF	08.93 - 01.00	2,0	6	105	OXY415.065
Xedos 9 2.5 24V	KL	07.93 - 07.00	2,5	6	123	OXY415.065
<b>Mercedes</b>						
400 SE, SEL (W140)	M119.971	02.91 - 10.98	4,2	8	210	OXY406.037
500 SE, SEL (W140)	M119.970	02.91 - 10.98	5,0	8	240	OXY406.037
600 SE, SEL (W140)	M120.980, M120.982	04.91 - 12.92	6,0	12	300	OXY406.037
A 150 (W169)	M266.920	09.04 - 06.12	1,5	4	70	OXY461.050

Typ Type	Motornummer Engine-No.	Jahr Year	Liter Litre	Zyl. Cyl.	KW	BBT-Nr. BBT-No.
A 160 (W169)	M266.920	04.09 - 06.12	1,6	4	70	OXY461.050
A 170 (W169)	M266.940	09.04 - 06.12	1,7	4	85	OXY461.050
A 180 (W169)	M266.940	04.09 - 06.12	1,7	4	85	OXY461.050
A 200 (W169)	M266.960	09.04 - 06.12	2,0	4	100	OXY461.050
A 200 Turbo (W169)	M266.980	09.05 - 06.12	2,0	4	142	OXY461.050
B 150 (W245)	M266.920	03.05 - 11.11	1,5	4	70	OXY461.050
B 160 (W245)	M266.920	04.09 - 11.11	1,5	4	70	OXY461.050
B 170 (W245)	M266.940	03.05 - 11.11	1,7	4	85	OXY461.050
B 180 (W245)	M266.940	04.09 - 11.11	1,7	4	85	OXY461.050
B 200 (W245)	M266.960	03.05 - 11.11	2,0	4	100	OXY461.050
B 200 Turbo (W245)	M266.980	03.05 - 11.11	2,0	4	142	OXY461.050
C 180 Kompressor (W203)	M 271.946	05.02 - 02.07	1,8	4	105	OXY472.090
C 180 Kompressor (W204)	M 271.910	01.08 ->	1,6	4	115	OXY472.090
C 180 Kompressor (W204)	M 271.952	01.07 - 02.07	1,8	4	115	OXY472.090
C 200 CGI Kompressor (W203)	M 271.942	07.03 - 02.07	1,8	4	125	OXY472.090
C 200 Kompressor (CL203)	M 111.955	03.01 - 05.02	2,0	4	120	OXY472.045
C 200 Kompressor (W203)	M 111.955	05.00 - 05.02	2,0	4	120	OXY472.045
C 200 Kompressor (W203)	M 271.940	05.02 - 02.07	1,8	4	120	OXY472.090
C 200 Kompressor (W204)	M 271.950	01.07 ->	1,8	4	135	OXY472.090
C 230 (W203)	M272.920	01.05 - 02.07	2,5	6	150	OXY461.050
C 230 (W204)	M272.921	01.07 ->	2,5	6	150	OXY461.050
C 230 4-matic (W204)	M272.911	07.07 ->	2,5	6	150	OXY461.050
C 230 Kompressor (CL203)	M 111.981	03.01 - 05.02	2,3	4	145	OXY472.045
C 230 Kompressor (W203)	M 271.948	02.04 ->	1,8	4	141	OXY472.090
C 280 (W203)	M272.940	01.05 - 02.07	3,0	6	170	OXY461.050
C 280 (W204)	M272.947	01.07 ->	3,0	6	170	OXY461.050
C 280 4-matic (W203)	M272.941	01.05 - 02.07	3,0	6	170	OXY461.050
C 280 4-matic (W204)	M272.948	07.07 ->	3,0	6	170	OXY461.050
C 300 (W204)	M272.947	07.09 ->	3,0	6	170	OXY461.050
C 300 4-matic (W204)	M272.948	07.07 ->	3,0	6	170	OXY461.050
C 350 (W204)	M272.962	01.07 ->	3,5	6	200	OXY461.050
C 350 CGI (W204)	M272.982	09.08 ->	3,5	6	215	OXY461.050
C 63 AMG (W204)	M272.985	02.08 ->	6,0	8	336	OXY461.050
CLC 160 (CL203)	M 271.911	02.09 - 06.11	1,6	4	95	OXY472.090
CLC 180 Kompressor (CL203)	M 271.946	05.08 - 06.11	1,8	4	105	OXY472.090
CLC 200 Kompressor (CL203)	M 271.955	05.08 - 06.11	1,8	4	135	OXY472.090
CLC 230	M272.920	05.08 - 06.11	2,5	6	150	OXY461.050
CLC 350	M272.960	05.08 - 06.11	3,5	6	200	OXY461.050
CLK 200 CGI (CL209)	M 271.942	07.03 - 05.09	1,8	4	125	OXY472.090
CLK 200 Kompressor (CL209)	M 271.940	09.02 - 05.09	1,8	4	120	OXY472.090
CLK 200 Kompressor (CL209)	M 271.955	10.06 - 05.09	1,8	4	135	OXY472.090
CLK 280 Cabriolet (A209)	M272.940	01.05 - 03.10	3,0	6	170	OXY461.050
CLK 350 Cabriolet (A209)	M272.960	01.05 - 03.10	3,5	6	200	OXY461.050
CLK 500 Cabriolet (A209)	M273.967	06.06 - 03.10	5,5	8	285	OXY461.050
CLK 63 AMG Cabriolet (A209)	M156.982	04.06 - 03.10	6,0	8	354	OXY461.050
CLS 280 (C219)	M272.943	07.08 - 12.10	3,0	6	170	OXY461.050
CLS 300 (C219)	M272.943	04.09 - 12.10	3,0	6	170	OXY461.050
CLS 350 (C219)	M272.964	10.04 - 12.10	3,5	6	200	OXY461.050
CLS 350 (C219)	M272.985	04.06 - 12.10	3,5	6	215	OXY461.050
CLS 350 CGI (C219)	M272.985	04.09 - 12.10	3,5	6	215	OXY461.050
CLS 500 (C219)	M 113.967	10.04 - 12.10	5,0	8	225	OXY472.045
CLS 500 (C219)	M273.960	04.06 - 12.10	5,5	8	285	OXY461.050
CLS 55 AMG (C219)	M 113.990	01.05 - 12.10	5,4	8	350	OXY472.045
E 200 Kompressor (W211)	M 271.941	11.02 - 12.08	1,8	4	120	OXY472.090
E 200 Kompressor (W211)	M 271.956	04.06 - 12.08	1,8	4	135	OXY472.090
E 230 (W211)	M272.922	09.07 - 12.08	2,5	6	150	OXY461.050
E 240 (W210)	M112.911	09.97 - 08.00	2,4	6	125	OXY442.042
E 240 (W211)	M 112.917, M 112.913	03.02 - 12.08	2,6	6	130	OXY472.045
E 280 (W210)	M112.921	12.96 - 06.00	2,8	6	150	OXY442.042

Typ Type	Motornummer Engine-No.	Jahr Year	Liter Litre	Zyl. Cyl.	KW	BBT-Nr. BBT-No.
E 280 (W211)	M272.943	03.05 - 12.08	3,0	6	170	OXY461.050
E 280 4-matic (W211)	M272.943	01.06 - 12.08	3,0	6	170	OXY461.050
E 320 (W210)	M112.941	07.99 - 06.00	3,2	6	165	OXY442.042
E 320 (W211)	M 112.949	03.02 - 12.08	3,2	6	165	OXY472.045
E 350 (W211)	M272.964	03.05 - 12.08	3,5	6	200	OXY461.050
E 350 4-matic (W211)	M272.964, M272.972	03.05 - 12.08	3,5	6	200	OXY461.050
E 350 CGI (W211)	M272.985	09.07 - 12.08	3,5	6	215	OXY461.050
E 350 CGI (W212)	M272.983	01.09 ->	3,5	6	215	OXY461.050
E 420 (W124)	M119.975	06.93 - 06.95	4,2	8	205	OXY406.037
E 430 (W210)	M113.940	07.99 - 06.00	4,3	8	205	OXY442.042
E 500 (W124)	M119.974	06.93 - 06.95	5,0	8	235	OXY406.037
E 500 (W211)	M 113.967	03.02 - 12.08	5,0	8	225	OXY472.045
E 500 CGI (W212)	M272.971	01.09 ->	5,4	8	285	OXY461.050
E 55 AMG (W210)	M113.980	06.99 - 06.00	5,4	8	260	OXY442.042
E 55 AMG Kompressor (W211)	M 113.990	10.02 - 12.08	5,4	8	350	OXY472.045
E 60 AMG (W124)	---	05.94 - 06.95	6,0	8	280	OXY406.037
E200 NGT (W211)	M 271.941	03.04 - 12.08	1,8	4	120	OXY472.090
GL 450 (X164)	M273.923	09.06 ->	4,6	8	250	OXY461.050
GL 500 (X164)	M273.963	09.06 ->	5,5	8	285	OXY461.050
ML 350 4-matic (W164)	M273.962	07.05 ->	3,5	6	200	OXY461.050
ML 500 4-matic (W164)	M273.963	12.07 ->	5,5	8	285	OXY461.050
R 280 (W251, V251)	M272.945	01.07 ->	3,0	6	170	OXY461.050
R 300 (W251, V251)	M272.945	07.09 ->	3,0	6	170	OXY461.050
R 350 (W251, V251)	M272.967	01.07 ->	3,5	6	200	OXY461.050
R 500 (W251, V251)	M273.963	01.07 ->	5,5	8	285	OXY461.050
S 280 (W220)	M112.922	01.99 - 08.05	2,8	6	150	OXY442.042
S 320 (W220)	M112.944	10.98 - 08.02	3,2	6	165	OXY442.042
S 350 4-matic (W221)	M272.965	02.08 ->	3,5	6	200	OXY461.050
S 420 (W140)	M119.971	01.93 - 10.98	4,2	8	205	OXY406.037
S 430 (W220)	M112.941	10.98 - 08.05	4,3	8	205	OXY442.042
S 500 (W140)	M119.970, M119.980	01.93 - 10.98	5,0	8	235	OXY406.037
S 500 (W220)	M113.960	10.98 - 08.05	5,0	8	225	OXY442.042
S 500 4-matic (W221)	M272.961	10.05 ->	5,5	6	285	OXY461.050
S 600 (W140)	M120.980, M120.982	01.93 - 10.98	6,0	12	290	OXY406.037
SL 280 (R129)	M104.943	08.93 - 10.01	2,8	6	142	OXY406.037
SL 280 (R230)	M272.949	03.08 - 01.12	3,0	6	170	OXY461.050
SL 300 (R129)	M103.984	03.89 - 08.93	3,0	6	140	OXY308.037
SL 300 (R230)	M272.949	04.09 - 01.12	3,0	6	170	OXY461.050
SL 320 (R129)	M104.991	09.93 - 10.01	3,2	6	170	OXY406.037
SL 350 (R230)	M272.966	03.06 - 01.12	3,5	6	200	OXY461.050
SL 350 (R230)	M272.968	04.08 - 01.12	3,5	6	232	OXY461.050
SL 500 (R129)	M119.960, M119.972	09.89 - 08.92	5,0	8	240	OXY308.037
SL 500 (R230)	M272.965	03.06 - 01.12	5,5	8	285	OXY461.050
SL 600 (R129)	M120.980, M120.983	07.92 - 10.01	6,0	12	290	OXY406.037
SLK 200 Kompressor (R171)	M 271.944	03.04 - 02.11	1,8	4	120	OXY472.090
SLK 200 Kompressor (R171)	M 271.954	01.08 - 02.11	1,8	4	135	OXY472.090
SLK 280 (R171)	M272.942	01.05 - 02.11	3,0	6	170	OXY461.050
SLK 300 (R171)	M272.942	04.09 - 02.11	3,0	6	170	OXY461.050

## Nissan

Almera II 1.5	QG15DE	07.00 ->	1,5	4	66	OXY469.037
Almera II 1.5	QG15DE	10.02 ->	1,5	4	72	OXY469.037
Almera II 1.8	QG18DE	07.00 ->	1,8	4	84	OXY469.037
Almera II 1.8	QG18DE	10.02 ->	1,8	4	85	OXY469.037
Almera Tino 1.8	QG18DE	12.02 ->	1,8	4	85	OXY469.037
Kubistar 1.2	D7F 764	08.03 ->	1,2	4	44	OXY471.045
Kubistar 1.6	K4M 720	08.03 ->	1,6	4	70	OXY471.045
Micra 1.0	MA10S	12.82 - 12.89	1,0	4	37	OXY102.020
Micra 1.0	MA10S	12.82 - 05.89	1,0	4	40	OXY102.020

Typ Type	Motornummer Engine-No.	Jahr Year	Liter Litre	Zyl. Cyl.	KW	BBT-Nr. BBT-No.
Micra 1.2	MA12S	07.86 - 07.92	1,2	4	40	OXY102.020
Pick Up 2.4 i 12V	KA24E	04.92 - 02.98	2,4	4	91	OXY102.020
Primastar 2.0	F4R 720	02.03 ->	2,0	4	88	OXY471.045
Primera 1.6	GA16DS	06.90 - 01.96	1,6	4	66	OXY102.020
Primera 1.6	QG16DE	01.02 ->	1,6	4	80	OXY469.037
Primera 1.8	QG18DE	03.02 ->	1,8	4	85	OXY469.037
Primera Traveller 1.8	QG18DE	03.02 ->	1,8	4	85	OXY469.037
Sunny III Traveller 1.6 i	GA16DE, GA16DS	06.91 - 03.00	1,6	4	66	OXY102.020
Vanette 2.4 i	Z24i	10.86 - 12.95	2,4	4	77	OXY102.020

## Opel

Agila 1.0	Z 10 XEP	08.03 ->	1,0	3	44	OXY470.052
Agila 1.0	Z 10 XEP	08.03 - 02.08	1,0	3	44	OXY470.030
Agila 1.2 16V	Z 12 XE	09.00 - 06.04	1,2	4	55	OXY470.030
Agila 1.2 16V Twinport	Z 12 XEP	07.04 - 02.08	1,2	4	59	OXY470.030
Agila 1.0 12V	Z 10 XE	09.00 - 08.03	1,0	3	43	OXY470.030
Ascona C 1.8 E	C 18 NE, S 18 NV	01.85 - 08.86	1,8	4	74	OXY308.091
Ascona C 2.0 i	20 NE	09.86 - 08.88	2,0	4	85	OXY308.091
Ascona C 2.0 i Kat.	C 20 NE	09.86 - 08.88	2,0	4	85	OXY308.091
Astra F 2.0 i 16V	X 20 XEV	02.95 - 07.95	2,0	4	100	OXY423.083
Astra G 1.2 16V	Z 12 XE	09.00 - 09.03	1,2	4	55	OXY470.030
Astra G 1.4	Z 14 XEP	09.03 - 01.05	1,4	4	66	OXY470.052
Astra G 1.4 16V	X 14 XE, Z 14 XE	09.98 - 01.05	1,4	4	66	OXY473.057
Astra G Cabriolet 1.6 16V	Z 16 XE	03.01 - 10.05	1,6	4	74	OXY473.057
Astra G Caravan 1.4 16V	X 14 XE, Z 14 XE	06.98 - 07.04	1,4	4	66	OXY473.057
Astra G Caravan 1.6 16V	Z 16 XE, X 16 XEL	02.98 - 07.04	1,6	4	74	OXY473.057
Astra G Caravan 1.6 CNG	Z 16 YNG	03.03 - 07.04	1,6	4	71	OXY473.057
Astra G CC 1.4 16V	X 14 XE, Z 14 XE	02.98 - 01.05	1,4	4	66	OXY473.057
Astra H 1.2	Z 12 XEP	08.05 ->	1,2	4	59	OXY470.052
Astra H 1.2 GTC	Z 12 XEP	08.05 ->	1,2	4	59	OXY470.052
Astra H 1.4	Z 14 XEP	03.04 ->	1,4	4	66	OXY470.052
Astra H 1.4	Z 14 XEP	03.04 ->	1,4	4	66	OXY470.030
Astra H 1.4 GTC	Z 14 XEP	03.05 ->	1,4	4	66	OXY470.052
Astra H 1.4 GTC	Z 14 XEP	03.05 ->	1,4	4	66	OXY470.030
Astra H 2.0 Turbo	Z 20 LEH	03.05 - 09.05	2,0	4	177	OXY470.052
Astra H 2.0 Turbo	Z 20 LEL	03.04 ->	2,0	4	125	OXY470.052
Astra H 2.0 Turbo	Z 20 LER	09.04 ->	2,0	4	147	OXY470.052
Calibra A 2.0 i	C 20 NE	06.90 - 07.97	2,0	4	85	OXY308.091
Calibra A 2.0 i 16V	C 20 XE	06.90 - 02.94	2,0	4	110	OXY308.091
Calibra A 2.0 i 16V	C 20 XEV	06.90 - 02.94	2,0	4	100	OXY423.083
Calibra A 2.0 i 16V	X 20 XEV	02.94 - 07.97	2,0	4	100	OXY423.083
Combo 1.4 16V	Z 14 XEP	08.05 ->	1,4	4	66	OXY470.052
Combo Tour 1.4	Z 14 XEP	10.04 ->	1,4	4	66	OXY470.052
Combo Tour 1.6 CNG	Z 16 YNG	04.05 ->	1,6	4	71	OXY473.057
Corsa A CC 1.6 GSI	C 16 SE	09.89 - 03.93	1,6	4	72	OXY308.091
Corsa A CC 1.6 GSI	E 16 SE	05.88 - 03.92	1,6	4	74	OXY308.091
Corsa A CC 1.6 GSI Kat.	C 16 SE	02.92 - 03.93	1,6	4	74	OXY308.091
Corsa C 1.0	Z 10 XE	09.00 - 08.03	1,0	3	43	OXY470.030
Corsa C 1.0	Z 10 XEP	06.03 - 09.06	1,0	3	44	OXY470.030
Corsa C 1.2	Z 10 XE	09.00 - 06.04	1,2	4	55	OXY470.030
Corsa C 1.2 Twinport	Z 14 XEP	07.04 - 09.06	1,2	4	59	OXY470.030
Corsa C 1.2 Twinport	Z 12 XEP	07.04 ->	1,2	4	59	OXY470.052
Corsa C 1.4	Z 14 XE	09.00 ->	1,4	4	66	OXY473.057
Corsa D 1.0	Z 10 XEP	07.06 ->	1,0	3	44	OXY470.030
Corsa D 1.2	Z 12 XEP	07.06 ->	1,2	4	59	OXY470.030
Corsa D 1.2 ecoFlex	---	09.09 ->	1,2	4	57	OXY470.030
Corsa D 1.4	Z 14 XEP	07.06 ->	1,4	4	66	OXY470.030
Corsa D 1.4 ecoFlex	---	09.09 ->	1,4	4	64	OXY470.030
Frontera A 2.2 i	X 22 XE	03.95 - 10.98	2,2	4	100	OXY308.055

Typ Type	Motornummer Engine-No.	Jahr Year	Liter Litre	Zyl. Cyl.	KW	BBT-Nr. BBT-No.
Frontera A 2.4 i	C 20 NE	03.92 - 10.98	2,4	4	92	OXY308.091
Kadett E 1.8 i	C 18 NE	10.85 - 08.86	1,8	4	74	OXY308.091
Kadett E 2.0 i	20 NE	03.87 - 08.91	2,0	4	85	OXY308.091
kadett E 2.0 i Kat.	C 20 NE	03.87 - 08.91	2,0	4	85	OXY308.091
Mervia 1.4 16V Twinport	Z 14 XEP	07.04 ->	1,4	4	66	OXY470.052
Mervia 1.4 16V Twinport	Z 14 XEP	07.04 ->	1,4	4	66	OXY470.030
Mervia 1.6 16V	Z 16 XE	05.03 - 05.10	1,6	4	74	OXY473.057
Monerey A 3.2	6VD1	06.92 - 07.98	3,2	6	130	OXY356.040
Monza A 3.0 GSE	C 30 LE	09.85 - 08.86	3,0	6	115	OXY308.091
Omega A 3.0	C 30 LE	03.87 - 12.87	3,0	6	115	OXY308.091
Omega A 3.0 24V	C 30 SE	09.89 - 03.94	3,0	6	150	OXY308.091
Omega A 3.0 24V	C 30 SEJ	09.89 - 03.94	3,0	6	147	OXY308.091
Omega B 2.5 V6	X 25 XE	03.94 - 09.00	2,5	6	125	OXY308.055
Omega B 2.6 V6	Y 26 SE	09.00 - 07.03	2,6	6	132	OXY470.030
Omega B 3.0 V6	X 30 XE	04.94 - 02.01	3,0	6	155	OXY308.055
Omega B 3.2 V6	Y 32 SE	02.01 - 07.03	3,2	6	160	OXY470.030
Senator A 3.0	C 30 LE	09.85 - 08.87	3,0	6	115	OXY308.091
Senator B 3.0	30 NE	01.88 - 09.90	3,0	6	130	OXY308.091
Senator B 3.0	C 30 LE	09.87 - 09.93	3,0	6	115	OXY308.091
Signum 3.2 V6	Z 32 SE	05.03 ->	3,2	6	155	OXY470.030
Sintra 2.2 i 16V	C 30 SE	11.96 - 04.99	2,2	4	104	OXY308.091
Sintra 3.0 i 24V	X 30 XE	11.96 - 04.99	3,0	6	148	OXY308.055
Speedster 2.0 Turbo	Z 20 LET	04.03 - 09.06	2,0	4	147	OXY470.052
Tigra Twintop 1.4	Z 14 XEP	06.04 ->	1,4	4	66	OXY470.052
Vectra C 1.6 16V	Z 16 XE	06.04 ->	1,6	4	74	OXY473.057
Vectra A 2.0	C 20 NEF	09.88 - 09.89	2,0	4	74	OXY308.091
Vectra A 2.0 i 16V	X 20 XEV	06.94 - 11.95	2,0	4	100	OXY423.083
Vectra A 2.0 i Kat.	C 20 NE	09.88 - 11.95	2,0	4	85	OXY308.091
Vectra A 2.5 V6	C 25 XE	02.93 - 11.95	2,5	6	125	OXY308.091
Vectra A 2000/GT 16V	20 XEJ	01.89 - 06.94	2,0	4	110	OXY308.091
Vectra B 2.5 i V6	X 25XE	10.95 - 09.00	2,5	6	125	OXY308.091
Vectra C 3.2 GTS V6	Z 32 SE	08.02 - 09.05	3,2	6	155	OXY470.030
Vectra C 3.2 V6	Z 32 SE	08.02 - 09.05	3,2	6	155	OXY470.030
Vivaro 2.0 16V	F4R 720	08.01 ->	2,0	4	88	OXY471.045
Zafira 1.6 16V	Z 16 XE, X 16 XEL	04.99 - 06.05	1,6	4	74	OXY473.057
Zafira 1.6 CNG	Z 16 YNG	09.01 - 06.05	1,6	4	71	OXY473.057
Zafira 1.6 CNG	Z 16 YNG	09.01 - 06.05	1,6	4	71	OXY452.120
Zafira 2.0	Z 20 LEH	01.06 ->	2,0	4	177	OXY470.052
Zafira 2.0	Z 20 LER	07.05 ->	2,0	4	147	OXY470.052
Zafira 2.0 OPC	Z 20 LER. Z 20 LET	11.02 - 06.05	2,0	4	147	OXY470.052
Zafira 2.0 OPC	Z 20 LET	09.01 - 06.05	2,0	4	141	OXY470.052
Zafira 2.2	Z 22 YH	07.05 ->	2,2	4	110	OXY470.052

## Peugeot

106 I 1.0	CDY (TU1M)	09.91 - 04.96	1,0	4	33	OXY418.045
106 I 1.1	HDZ (TU1M)	09.91 - 04.96	1,1	4	44	OXY418.045
106 I 1.3	TU2J2	10.93 - 04.96	1,3	4	72	OXY418.045
106 I 1.4	KDX (TU3MC), KDY (TU3M)	09.91 - 04.96	1,4	4	55	OXY418.045
106 I 1.4	KFZ (TU3J2/Z)	09.91 - 04.96	1,4	4	69	OXY418.045
106 I 1.6	NFY (TU5J2)	01.94 - 04.96	1,6	4	76	OXY418.045
106 I 1.6	NFZ (TU5JP)	06.93 - 04.96	1,6	4	65	OXY418.045
106 II 1.0 i	CDZ (TU5M)	01.97 - 05.05	1,0	4	37	OXY420.037
106 II 1.0 i	DDY (TU9M)	05.96 - 05.05	1,0	4	33	OXY420.037
106 II 1.1 i	HDY (TU1M)	01.97 - 05.05	1,1	4	40	OXY420.037
106 II 1.1 i	HDZ (TU1M)	05.96 - 05.05	1,1	4	44	OXY420.037
106 II 1.1 i	HDZ (TU1M), HFX (TU1JP)	05.96 ->	1,1	4	44	OXY459.057
106 II 1.4 i -> EURO 93	KFX (TU3JP)	02.98 - 05.05	1,4	4	55	OXY420.037
106 II 1.6 i	NFW (TU5J2), NFY (TU5J2)	05.96 - 05.05	1,6	4	74	OXY420.037
106 II 1.6 i	NFZ (TU5JP)	05.96 - 05.05	1,6	4	65	OXY420.037

Typ Type	Motornummer Engine-No.	Jahr Year	Liter Litre	Zyl. Cyl.	KW	BBT-Nr. BBT-No.
206 1.4 i	KFW (TU3JP), KFX (TU3JP)	09.98 ->	1,4	4	55	OXY420.055
206 1.4 16V	KFU (ET3J4)	10.03 ->	1,4	4	65	OXY459.057
206 1.6 16V	NFU (TU5JP4)	12.00 ->	1,6	4	80	OXY459.057
206 2.0 S16	RFN (EW10J4)	10.00 ->	2,0	4	100	OXY459.057
206 CC 1.6 16V	NFU (TU5JP4)	09.00 ->	1,6	4	80	OXY459.057
206 CC 20. S16	RFN (EW10J4)	09.00 ->	2,0	4	100	OXY459.057
306 1.1	HDZ (TU1M)	06.94 - 05.01	1,1	4	44	OXY418.045
306 1.4 SL	KDX (TU3MC), KFW (TU3JP), KFX (TU3JP)	06.94 - 05.01	1,4	4	55	OXY418.045
306 1.6	NFT	10.00 - 05.01	1,6	4	72	OXY459.057
306 1.6 SR	NFZ (TU5JP)	06.94 - 10.00	1,6	4	65	OXY418.045
306 1.8 16V	LFY (XU7JP4)	03.97 - 05.01	1,8	4	81	OXY459.057
306 1.8 ST	LFZ (XU79JP)	06.94 - 05.01	1,8	4	74	OXY418.150
306 2.0 S16	RFT (XU10J4)	06.94 - 05.01	2,0	4	110	OXY418.150
306 2.0 S16	RFY (XU10J4Z)	06.94 - 05.01	2,0	4	112	OXY418.150
306 2.0 ST	RFX (XU10J2)	07.94 - 05.01	2,0	4	89	OXY418.150
307 1.6 16V	NFU (TU5JP4)	08.00 ->	1,6	4	80	OXY459.057
405 II 1.4	KDX (TU3MC)	08.92 - 10.95	1,4	4	55	OXY418.150
405 II 1.6	BDY (XU5M2Z), BDY (XU5M3Z)	08.92 - 10.95	1,6	4	65	OXY418.150
405 II 1.8	LFZ (XU79JP)	08.92 - 10.95	1,8	4	74	OXY418.150
405 II 2.0	RFX (XU10J2)	08.92 - 10.95	2,0	4	89	OXY418.150
406 1.6	BFZ (XU5JP)	11.95 - 05.04	1,6	4	65	OXY420.037
406 1.8 16V	6FZ (EW7J4)	10.00 - 05.04	1,8	4	85	OXY420.055
406 2.0 16V	RFR (DEW10J4)	01.99 - 08.00	2,0	4	99	OXY459.057
406 3.0 V6	XFX (ES9J4S)	03.00 - 05.04	3,0	6	152	OXY459.057
407 3.0	XFV (ES9A)	05.04 ->	3,0	6	155	OXY459.057
605 2.0 i	RFZ (XU10J2Z)	06.89 - 09.99	2,0	4	89	OXY418.150
605 2.0 Turbo	RGY (XU10J2TE)	07.92 - 09.99	2,0	4	104	OXY418.150
607 2.2 16V	3FY (EW12J4)	09.05 ->	2,2	4	120	OXY459.057
607 3.0 V6 24V	XFX (ES9J4S)	02.00 ->	3,0	6	152	OXY459.057
Boxer 2.0	RFL (XU10J2U)	04.02 ->	2,0	4	81	OXY459.057
Boxer 2.0 i	RFW (XU10J2)	03.94 - 04.02	2,0	4	80	OXY418.150
Partner 1.1	HDZ (TU1M)	07.96 - 08.02	1,1	4	44	OXY420.037
Partner 1.4	KFX (TU3JP), TU32	07.96 - 07.98	1,4	4	55	OXY420.037
Partner 1.4 BiFuel	KFW (TU3JP)	04.03 ->	1,4	4	55	OXY420.055
Partner Combispace 1.6 16V	NFU (TU5JP4)	07.01 ->	1,6	4	80	OXY459.057
Partner Combispace 1.8	LFX (XU7JB)	05.97 ->	1,8	4	66	OXY420.063
<b>Porsche</b>						
911 (993) Carrera 3.6	M64.05, M64.06	10.93 - 08.95	3,6	6	200	OXY420.104
911 (993) Carrera 3.6	M64.21, M64.22, M64.24	08.95 - 09.97	3,6	6	210	OXY420.104
911 (993) Carrera 4 3.6	M64.01	08.95 - 09.97	3,6	6	210	OXY420.104
911 (993) Carrera 4 3.6	M64.05	07.94 - 08.95	3,6	6	200	OXY420.104
911 (993) Carrera 4 RS 3.8	M64.20	08.95 - 09.97	3,8	6	221	OXY420.104
911 (993) Carrera RS 3.8	M64.20	06.95 - 09.97	3,8	6	221	OXY420.104
911 (993) Carrera Targa 3.6	M64.21	08.95 - 09.97	3,6	6	210	OXY420.104
911 (993) Carrera Targa 3.7	M64.20	05.96 - 09.97	3,7	6	221	OXY420.104
<b>Renault</b>						
21 1.7	F3N 722, F3N 723	09.89 - 06.94	1,7	4	66	OXY321.036
Avantime 3.0 V6	L7X 720, L7X721	11.00 - 12.02	3,0	6	166	OXY459.057
Clio II 1.4	E7J 780	09.98 - 05.05	1,4	4	55	OXY336.026
Clio II 1.6	K7M 744, K7M 745	09.98 - 05.05	1,6	4	55	OXY336.026
Clio II 3.0 V6 Sport	L7X 762	12.02 ->	3,0	6	187	OXY459.057
Clio III 1.6 16V	K4M 800, K4M 801	06.05 ->	1,6	4	82	OXY471.045
Clio III 1.6 16V	K4M 804	06.05 ->	1,6	4	65	OXY471.045
Clio III 2.0 16V Sport	F4R 830	02.06 ->	2,0	4	145	OXY471.045
Espace II 2.0	J7R 768	01.91 - 10.96	2,0	4	76	OXY321.036
Espace II 2.8 V6	Z7W 712, -713, -717	01.91 - 10.96	2,8	6	110	OXY321.036
Espace III 2.0	F3R 728, -729, -742, -768, -769	11.96 - 10.00	2,0	4	84	OXY445.025

Typ Type	Motornummer Engine-No.	Jahr Year	Liter Litre	Zyl. Cyl.	KW	BBT-Nr. BBT-No.
Espace III 2.0	F4R 700, F4R 701	09.01 - 10.02	2,0	4	102	OXY471.045
Espace IV 2.0	F4R 790, F4R 701, F4R 792	11.02 ->	2,0	4	100	OXY471.045
Grand Scenic II 1.6	K4M 761, K4M 782	04.04 ->	1,6	4	83	OXY471.045
Grand Scenic II 2.0	F4R 770, F4R 771	04.04 ->	2,0	4	99	OXY471.045
Kangoo 1.4	E7J 634, -635, -700, -701, -780	08.97 ->	1,4	4	55	OXY336.026
Kangoo Rapid 1.4	E7J 634, -635, -700, -701, -780	08.97 ->	1,4	4	55	OXY336.026
Laguna 1.8	F3P 674	09.95 - 02.01	1,8	4	69	OXY445.025
Laguna 1.8	F3P 676	05.98 - 06.98	1,8	4	70	OXY445.025
Laguna 1.8	F3P 760	09.95 - 03.01	1,8	4	66	OXY445.025
Laguna 2.0	F3R 611	03.99 - 02.01	2,0	4	80	OXY445.025
Laguna 2.0	F3R 768	09.95 - 02.01	2,0	4	84	OXY445.025
Laguna Grandtour 1.8	F3P 670	09.95 - 04.97	1,8	4	66	OXY445.025
Laguna Grandtour 2.0	F3R 768	10.98 - 01.01	2,0	4	84	OXY445.025
Laguna II 1.6 16V	K4M 716	02.05 ->	1,6	4	82	OXY471.045
Laguna II 3.0 V6 24V	L7X 731	03.01 ->	3,0	6	152	OXY459.057
Megane I 2.0 16V	F7R 710, F7R 714	07.96 - 10.02	2,0	4	108	OXY445.025
Megane I 2.0 i	F3R 750, F3R 751	01.96 - 02.99	2,0	4	84	OXY445.025
Megane II 1.4 16V	K4J 732	10.03 ->	1,4	4	60	OXY471.045
Megane II 1.6 16V	K4J 730, K4J 740	11.02 ->	1,6	4	72	OXY471.045
Megane II 1.6 16V	K4M 760	11.02 ->	1,6	4	83	OXY471.045
Megane II 2.0 16V	F4R 770	11.02 ->	2,0	4	99	OXY471.045
Modus 1.6	K4M 790, K4M 791	12.04 ->	1,6	4	82	OXY471.045
Modus 1.6	K4M 792, K4M 794	12.04 ->	1,6	4	65	OXY471.045
Scenic I 1.4 16V	K4J 714, K4J 750	09.99 - 08.03	1,4	4	70	OXY471.045
Scenic I 1.6 16V	K4M 700, -701, -704, -708	09.99 - 08.03	1,6	4	79	OXY471.045
Scenic II 1.6	K4M 761, K4M 782	06.03 ->	1,6	4	83	OXY471.045
Scenic II 1.6 16V	K4M 812, K4M 9 766, K4M C 813	01.07 ->	1,6	4	82	OXY471.045
Scenic II 2.0	F4R 770, F4R 771	06.03 ->	2,0	4	99	OXY471.045
Sport Spider 2.0 16V	F3R 710	05.96 - 10.99	2,0	4	110	OXY445.025
Super 5 1.4	C1J 768, C1J 780	10.84 - 06.88	1,4	4	43	OXY102.047
Thalia 1.4 16V	K4J 712	08.00 ->	1,4	4	72	OXY471.045
Trafic II 2.0	F4R 720, F4R 722	03.01 ->	2,0	4	88	OXY471.045

## Seat

Alhambra 1.8 T 20V	AJH, AWC	10.97 - 03.10	1,8	4	110	OXY452.120
Alhambra 2.0 i	ADY, ATM	04.96 - 03.10	2,0	4	85	OXY452.120
Altea 1.8 TFSI	BZB, CDAA, BYT	01.07 ->	1,8	4	118	OXY474.080
Altea XL 1.8 TFSI	BZB, CDAA, BYT	01.07 ->	1,8	4	118	OXY474.080
Arosa 1.0	ALL	10.97 - 05.99	1,0	4	37	OXY451.072
Arosa 1.4	AEX, AKV, APQ	05.97 - 09.99	1,4	4	44	OXY451.072
Cordoba 1.0 i	AER	09.96 - 06.99	1,0	4	37	OXY415.087
Cordoba 1.0 i	AER	11.98 - 06.99	1,0	4	37	OXY451.072
Cordoba 1.2	AZQ	10.02 - 06.06	1,2	3	47	OXY452.026
Cordoba 1.4 i	ABD, AEX, APQ	06.94 - 06.99	1,4	4	44	OXY415.087
Cordoba 1.4 i	AKV	11.98 - 06.99	1,4	4	44	OXY451.072
Cordoba 1.4 i 16V	AFH	09.96 - 06.99	1,4	4	74	OXY415.057
Cordoba 1.6	BAH	04.03 - 11.09	1,6	4	74	OXY452.031
Cordoba 1.6	ALM	06.99 - 10.02	1,6	4	55	OXY415.057
Exeo 1.8 TSI	CDHA	09.10 ->	1,8	4	88	OXY474.080
Exeo 1.8 TSI	CDHB	05.10 ->	1,8	4	118	OXY474.080
Exeo 2.0 TFSI	CDND	05.10 ->	2,0	4	155	OXY474.080
Exeo ST 1.8 TSI	CDHA	09.10 ->	1,8	4	88	OXY474.080
Exeo ST 1.8 TSI	CDHB	05.10 ->	1,8	4	118	OXY474.080
Exeo ST 2.0 TFSI	CDND	05.10 ->	2,0	4	155	OXY474.080
Ibiza II 1.0 i	AER	09.96 - 08.99	1,0	4	37	OXY415.087
Ibiza II 1.0 i	AER	11.98 - 08.99	1,0	4	37	OXY451.072
Ibiza II 1.4 i	ABD, AEX	09.93 - 08.99	1,4	4	44	OXY415.087
Ibiza II 1.4 i 16V	AFH	09.96 - 08.99	1,4	4	74	OXY415.057
Ibiza IV 1.2	AZQ	02.02 - 06.06	1,2	3	47	OXY452.026

Typ Type	Motornummer Engine-No.	Jahr Year	Liter Litre	Zyl. Cyl.	KW	BBT-Nr. BBT-No.
Ibiza IV 1.6	BAH	02.03 - 11.09	1,6	4	74	OXY452.031
Ibiza IV 1.8 Cupra R	BBU	01.04 - 02.08	1,8	4	132	OXY452.120
Ibiza IV 1.8 T FR	BJX, BKV	12.03 - 05.08	1,8	4	110	OXY452.120
Inca 1.4 i	AEX, AKV, APQ, AUD	11.95 - 06.03	1,4	4	44	OXY415.087
Inca 1.4 i	AKV, APQ	10.98 - 06.03	1,4	4	44	OXY451.072
Inca 1.6 i	AEE	11.95 - 05.98	1,6	4	55	OXY415.057
Leon 1.6	AEH, AKL	11.99 - 06.06	1,6	4	74	OXY452.120
Leon 1.8 20V	AGN	11.99 - 12.03	1,8	4	92	OXY451.072
Leon 1.8 T 20V	APP, AUQ	11.99 - 06.06	1,8	4	132	OXY452.120
Leon 2.0 Cupra R	CDLA	09.09 ->	2,0	4	195	OXY474.080
Leon 2.0 TFSI	CCZB	06.09 ->	2,0	4	155	OXY474.080
Leon 2.8 Cupra 4	AUE	02.01 - 06.06	2,8	4	150	OXY452.031
Toledo I 1.6 i	1F	01.93 - 03.99	1,6	4	55	OXY415.065
Toledo I 1.6 i	1F, ABN, EZ	05.91 - 03.99	1,6	4	54	OXY415.065
Toledo I 1.8 16V	PL	05.91 - 03.99	1,8	4	92	OXY321.090
Toledo I 1.8 i	ABS, ADZ	11.93 - 12.96	1,8	4	66	OXY415.065
Toledo I 2.0 i	2E, AGG	05.91 - 03.99	2,0	4	85	OXY415.065
Toledo II 1.6	AEH, AKL	04.99 - 09.00	1,6	4	74	OXY452.120
Toledo II 1.8 20V	AGN	04.99 - 12.03	1,8	4	92	OXY451.072
Toledo II 1.8 T 20V	AUQ	05.01 - 05.06	1,8	4	132	OXY452.120
Toledo II 2.3 V5	AGZ	04.99 - 11.00	2,3	5	110	OXY451.072
<b>Skoda</b>						
Fabia 1.0	AQV, ARV, ATY	12.99 - 08.02	1,0	4	37	OXY452.031
Fabia 1.2	AWY, BME	08.02 - 03.08	1,2	3	40	OXY452.026
Fabia 1.2	AZQ	01.03 - 03.08	1,2	3	47	OXY452.026
Fabia 1.4	AME, AQW, ATZ	08.99 - 03.08	1,4	4	50	OXY452.031
Fabia 1.4	AZE, AZF	08.00 - 08.02	1,4	4	44	OXY452.031
Fabia Praktik 1.2	AZQ	01.03 - 12.07	1,2	3	47	OXY452.026
Fabia Praktik 1.4	AME, AQW, ATZ	07.01 - 12.07	1,4	4	50	OXY452.031
Favorit 135 1.3	781.135	12.91 - 09.94	1,3	4	43	OXY321.071
Octavia 1.6	AEH	04.97 - 12.07	1,6	4	74	OXY451.050
Octavia 1.6	AKL	02.97 - 12.07	1,6	4	74	OXY452.120
OCtavia 1.8 T	AGU, ARX, ARZ, AUM	08.97 - 12.10	1,8	4	110	OXY452.120
Octavia 1.8 TSI	BZB, CDAA	06.07 ->	1,8	4	118	OXY474.080
Octavia 1.8 TSI	CDAB	03.09 ->	1,8	4	112	OXY474.080
Octavia 2.0	AEG, APK, AQY, AZH	05.01 - 05.07	2,0	4	85	OXY452.120
Octavia 2.0 RS	BWA, CCZA	10.05 ->	2,0	4	147	OXY474.080
Superb 1.8 TSI	BZB, CDAA	03.08 ->	1,8	4	118	OXY474.080
Superb 2.0 TSI	CCZA	05.10 ->	2,0	4	147	OXY474.080
Yeti 1.8 TSI 4x4	CDAA	05.09 ->	1,8	4	118	OXY474.080
Yeti 1.8 TSI 4x4	CDAB	11.09 ->	1,8	4	112	OXY474.080
<b>Subaru</b>						
Forester 2.0	EJ20	09.02 ->	2,0	4	92	OXY464.051
Justy II 1.3 GX 4x4	EF13	10.95 - 11.03	1,3	4	50	OXY101.040
Legacy III 2.0	EJ20	04.99 - 08.03	2,0	4	92	OXY464.051
Legacy IV 2.0	EJ20	09.03 ->	2,0	4	101	OXY464.051
Legacy IV 2.5	EJ25	09.03 ->	2,5	4	121	OXY464.051
Outback 2.5	EJ25	10.00 - 08.03	2,5	4	115	OXY464.051
<b>Suzuki</b>						
Alto IV 1.1	FD10, F10DN	06.02 - 12.08	1,1	4	46	OXY466.050
Swift I 1.3 Cabriolet	G13B	09.91 - 10.96	1,3	4	50	OXY101.040
Swift I 1.0	G10, G10A	10.83 - 03.89	1,0	3	37	OXY101.040
Swift II 1.3	G13A	03.89 - 12.91	1,3	4	52	OXY101.040
Swift II 1.3	G13A	03.89 - 05.01	1,3	4	50	OXY101.040
Swift II 1.6	G16B	11.89 - 12.91	1,3	4	70	OXY101.040
Swift II 1.6 i	G16B	01.90 - 05.01	1,6	4	68	OXY101.040

Typ Type	Motornummer Engine-No.	Jahr Year	Liter Litre	Zyl. Cyl.	KW	BBT-Nr. BBT-No.
<b>Toyota</b>						
Camry 3.0 V6	1MZ-FE	11.01 - 11.06	3,0	6	137	OXY462.023
Prius Liftback 1.5	1NZ-FXE	08.03 - 03.09	1,5	4	57	OXY463.036
Yaris 1.0	1SZ-FE	03.03 - 09.05	1,0	4	48	OXY462.033
Yaris 1.3	2SZ-FE	04.02 - 09.05	1,3	4	64	OXY462.023
<b>Volkswagen</b>						
Amarok 2.0 TSI	CFPA	12.10 ->	2,0	4	118	OXY474.080
Bora 1.6	AEH, APF	10.98 - 05.05	1,6	4	74	OXY452.120
Bora 1.6	AKL	10.98 - 05.05	1,6	4	74	OXY451.050
Bora 1.8	AGN	10.98 - 10.00	1,8	4	92	OXY451.072
Bora 2.0	APK, AQY, AZG, AZH, AZJ, BBW	10.98 - 05.05	2,0	4	85	OXY452.120
Bora 2.3 V5 4motion	AQN	10.00 - 05.05	2,3	5	125	OXY452.031
Bora 2.8 V6 4motion	AQP, AUE, BDE	03.99 - 05.05	2,8	6	150	OXY452.031
Caddy II 1.4	AEX, AUD	11.95 - 01.04	1,4	4	44	OXY415.087
Caddy II 1.4	AKV, APQ	11.98 - 06.03	1,4	4	44	OXY451.072
CC 1.8 TSI	CDAA	11.11 ->	1,8	4	118	OXY474.080
CC 2.0 TSI	CCZB	11.11 ->	2,0	4	155	OXY474.080
Eos 2.0 TFSI	BWA, BPY, CBFA, CCZA, CAWB, CCTA	03.06 ->	2,0	4	147	OXY474.080
Eos 2.0 TSI	CCZB	11.09 ->	2,0	4	155	OXY474.080
Golf I Cabriolet 1.8	2H	08.89 - 03.93	1,8	4	72	OXY333.058
Golf III 1.4	ABD, AEX	11.91 - 08.97	1,4	4	40	OXY415.087
Golf III 2.0	2E, ADY, AGG, AKR	11.91 - 08.97	2,0	4	85	OXY415.065
Golf III 2.0 GTI 16V	ABF	08.92 - 12.94	2,0	4	110	OXY432.061
Golf III 2.8 VR6	AAA	01.92 - 08.97	2,8	6	128	OXY415.065
Golf III Cabriolet 1.8	AAM	07.93 - 05.98	1,8	4	55	OXY333.058
Golf III Cabriolet 1.8	ABS, ADZ	07.93 - 05.98	1,8	4	66	OXY333.058
Golf IV 1.6	AEH	10.97 - 02.00	1,6	4	74	OXY451.050
Golf IV 1.6	AKL, APF	08.97 - 02.00	1,6	4	74	OXY452.120
Golf IV 1.8	AGN, BAF	10.97 - 06.05	1,8	4	92	OXY451.072
Golf IV 1.8 T	AGU, AQA, ARZ, AUM, AWD	10.97 - 06.05	1,8	4	110	OXY451.072
Golf IV 1.8 T GTI	AUQ	08.01 - 06.05	1,8	4	132	OXY452.120
Golf IV 2.0	APK, AZG, AZJ	07.98 - 06.05	2,0	4	85	OXY452.120
Golf IV 2.3 V5 4motion	AQN	10.00 - 06.05	2,3	5	125	OXY452.031
Golf IV 2.8 V6 4motion	AQP, AUE, BDE	03.99 - 06.05	2,8	6	150	OXY452.031
Golf IV Cabriolet 1.8	ANN	06.98 - 06.02	1,8	4	55	OXY415.057
Golf IV Cabriolet 1.8	ANP	06.98 - 06.02	1,8	4	66	OXY415.057
Golf IV Cabriolet 2.0	AGG, AKR, ATU, AWF, AWG	06.98 - 06.02	2,0	4	85	OXY452.120
Golf IV R32 4motion	BFH, BML	09.02 - 06.05	3,2	6	177	OXY452.031
Golf IV Variant 2.0	APK, AQY, AZJ	05.99 - 06.06	2,0	4	85	OXY452.120
Golf VI 2.0 GTi	CCZB	04.09 - 11.12	2,0	4	155	OXY474.080
Golf VI 2.0 GTi	CDLG	05.11 - 11.12	2,0	4	173	OXY474.080
Golf VI Cabriolet 2.0 GTI	CCZB	11.11 ->	2,0	4	155	OXY474.080
Golf VI Cabriolet 2.0 R	CDLA	01.13 ->	2,0	4	195	OXY474.080
Jetta III 2.0 TFSI	BPY, BWA, CCTA	10.05 - 10.10	2,0	4	147	OXY452.120
Jetta III 2.0 TFSI	BWA, BPY, AXX, CBFA, CCZA, CAWB, CCTA	10.05 - 10.10	2,0	4	147	OXY474.080
Jetta III 2.5 FSI	BTK, BGP	01.06 - 10.10	2,5	5	110	OXY474.080
Jetta IV 2.5 FSI	CCCA, CBUA, CBTA	04.10 ->	2,5	5	125	OXY474.080
Lupo 1.0	ALL	09.98 - 05.00	1,0	4	37	OXY451.072
Lupo 1.4 16V	AFK	08.99 - 10.00	1,4	4	14	OXY451.072
Lupo 1.4 16V	AHW	10.98 - 05.04	1,4	4	55	OXY451.050
Multivan T5 2.0 TSI	CJKA	05.11 ->	2,0	4	150	OXY474.080
Multivan T5 2.0 TSI	CJKB	07.12 ->	2,0	4	110	OXY474.080
Multivan T5 2.0 TSI 4motion	CJKA	07.11 ->	2,0	4	150	OXY474.080
New Beetle 2.0	AQJ, AVH, AZJ, BER, CBPA	01.98 ->	2,0	4	85	OXY452.120
New Beetle 2.0 TSI	CBFA, CCZA, CCTA	04.11 ->	2,0	4	147	OXY474.080
New Beetle 2.5	CCCA, CBUA, CBTA	04.11 ->	2,5	5	125	OXY474.080
New Beetle 3.2 RSI	AXJ	04.00 - 05.01	3,2	6	165	OXY452.031
New Beetle Cabriolet 2.0 TSI	CBFA, CCZA, CCTA	12.12 ->	2,0	4	147	OXY474.080

Typ Type	Motornummer Engine-No.	Jahr Year	Liter Litre	Zyl. Cyl.	KW	BBT-Nr. BBT-No.
New Beetle Cabriolet 1.8 T	AWU, AWV, BKF	01.03 - 09.10	1,8	4	110	OXY452.120
Passat 1.8	ADR, APT, ARG	10.96 - 11.00	1,8	4	92	OXY452.120
Passat 1.6	ADP	10.96 - 10.98	1,6	4	74	OXY415.100
Passat 1.6	ADP, AHL, ANA, ARM	10.96 - 11.00	1,6	4	74	OXY452.120
Passat 1.8	ADR	12.96 - 12.98	1,8	4	92	OXY415.100
Passat 1.8 T	AEB, ANB, APU	10.96 - 11.00	1,8	4	110	OXY452.120
Passat 1.8 TSI	BZB, CDAA	05.07 - 07.10	1,8	4	118	OXY474.080
Passat 1.8 TSI	CDAA	08.10 ->	1,8	4	118	OXY474.080
Passat 2.0	2E	08.94 - 09.94	2,0	4	85	OXY432.061
Passat 2.0	ADY, AGG	02.90 - 08.96	2,0	4	85	OXY415.065
Passat 2.0	AEP	03.95 - 08.96	2,0	4	79	OXY415.065
Passat 2.0 FSI	BWA, BPY, AXX, CBFA, CCZA, CAWB, CCTA	07.05 - 07.10	2,0	4	147	OXY474.080
Passat 2.0 TSI	CCZB	11.10 ->	2,0	4	155	OXY474.080
Passat 2.8 V6	ACK, APR	08.96 - 11.00	2,8	6	142	OXY415.057
Passat CC 1.8 TSI	BZB, CDAA	06.08 - 11.10	1,8	4	118	OXY474.080
Passat CC 2.0 TSI	CBFA, CCZA, CAWB, CCTA	06.08 ->	2,0	4	147	OXY474.080
Phaeton 4.2 V8 4motion	BGH, BEJ	05.03 ->	4,2	8	246	OXY452.120
Polo 1.2 12V	BME	10.01 - 07.07	1,2	3	47	OXY452.026
Polo 100 1.4 16V	AFH	04.96 - 10.99	1,4	4	74	OXY415.100
Polo 100 1.4 16V	AFH	04.96 - 10.99	1,4	4	74	OXY451.072
Polo 120 1.6 GTI 16V	AJV	09.98 - 10.99	1,6	4	88	OXY451.050
Polo 45 1.0	AEV	10.94 - 09.96	1,0	4	33	OXY415.100
Polo 50 1.0	AER, ALL	09.96 - 10.99	1,0	4	37	OXY415.057
Polo 55 1.3	ADX	10.94 - 07.95	1,3	4	40	OXY415.100
Polo 55 1.4	AEX	08.95 - 10.99	1,4	4	40	OXY415.100
Polo 60 1.4	AEX, AKV, APQ	07.95 - 10.99	1,4	4	44	OXY415.100
Polo 75 1.6	AEA, AEE	10.94 - 10.99	1,6	4	55	OXY415.100
Polo Classic 100 1.6	AEH, AFT, AKL, APF, AUR	12.95 - 09.01	1,6	4	74	OXY415.065
Polo Classic 75 1.6	1F	11.95 - 09.97	1,6	4	55	OXY415.057
Polo Classic 75 1.6	AEE, ALM	11.95 - 09.01	1,6	4	55	OXY415.057
Scirocco 2.0 R	CDLA	11.09 ->	2,0	4	195	OXY474.080
Scirocco 2.0 R	CDLC	11.09 ->	2,0	4	188	OXY474.080
Scirocco 2.0 TSI	CCZB	11.09 - 05.11	2,0	4	155	OXY474.080
Sharan 1.8 T 20V	AJH, AWC	09.97 - 03.10	1,8	4	110	OXY452.120
Sharan 2.0	ADY, ATM	09.95 - 03.10	2,0	4	85	OXY452.120
Sharan 2.8 VR6	AAA	01.96 - 12.98	2,8	6	128	OXY415.087
Tiguan 2.0 TFSI 4motion	CCZA, CAWB, CCTA	09.07 ->	2,0	4	147	OXY474.080
Tiguan 2.0 TSI 4motion	CCZB	05.11 ->	2,0	4	155	OXY474.080
Tiguan 2.0 TSI 4motion	CCZD	05.11 ->	2,0	4	132	OXY474.080
Touareg 3.0 V6 TSI Hybrid	CGFA, CGEA	04.10 ->	2,0	6	245	OXY474.080
Touareg 3.6 V6 FSI	CGRA	04.10 ->	3,6	6	206	OXY474.080
Touareg 4.2 V8	AXQ, BHX	12.02 - 11.06	4,2	8	228	OXY452.120
Transporter T3 2.1 Syncro	SR	10.86 - 07.92	2,1	4	64	OXY321.090
Transporter T4 2.0	AAC	09.90 - 04.03	2,0	4	62	OXY415.065
Transporter T4 2.5	AAF, ACU, AEN, AEU	11.90 - 04.03	2,5	5	81	OXY415.065
Transporter T4 2.8 VR6	AES	05.96 - 05.00	2,8	6	103	OXY415.087
Transporter T5 2.0 TSI	CJKA	05.11 ->	2,0	4	150	OXY474.080
Transporter T5 2.0 TSI	CJKB	07.12 ->	2,0	4	110	OXY474.080
Transporter T5 2.0 TSI 4motion	CJKA	07.11 ->	2,0	4	150	OXY474.080
Vento 1.4	ABD, AEX	11.91 - 09.98	1,4	4	40	OXY415.087
Vento 2.0	2E, ADY, AGG, AKR	11.91 - 09.98	2,0	4	85	OXY415.065
Vento 2.8 VR6	AAA	05.96 - 12.97	2,8	6	128	OXY415.087
<b>Volvo</b>						
960 I 2.9	B 6304 F	08.90 - 07.94	2,9	6	150	OXY420.220
960 II 2.5	B 6254 S	07.94 - 12.96	2,5	6	125	OXY420.220
960 II 2.9	B 6304 S	07.94 - 12.96	2,5	6	150	OXY420.220
S40 II 1.6	B 4164 S3	01.05 ->	1,6	4	74	OXY468.064
S40 II 1.8	B 4184 S11	04.04 ->	1,8	4	92	OXY468.064



**OXY001U - Universal**

Länge / length  
OXY001U 330 mm

passend für / to fit  
**Audi, Daewoo, Mazda**

Regelsonde / Pre cat sensor

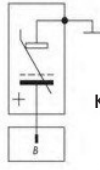

Kabel / cables

1

**OXY002U - Universal**

Länge / length  
OXY002U 180 mm

passend für / to fit  
**Renault, Toyota, VW**

Regelsonde / Pre cat sensor

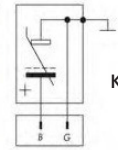

Kabel / cables

2

**OXY003U - Universal**

Länge / length  
OXY003U 180 mm

passend für / to fit  
**Audi, Fiat, Mercedes**

Regelsonde / Pre cat sensor

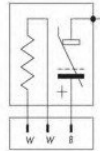

Kabel / cables

3

**OXY004U - Universal**

Länge / length  
OXY004U 350 mm

passend für / to fit  
**Audi, BMW, Citroën**

Regelsonde / Pre cat sensor

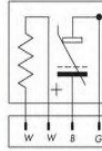

Kabel / cables

4

**OXY101.040**

Länge / length  
OXY101.040 400 mm

passend für / to fit  
**Daewoo, Subaru, Suzuki**

Regelsonde / Pre cat sensor



Kabel / cables

1

**OXY102.xxx**

Länge / length  
OXY102.020 200 mm  
OXY102.047 470 mm

passend für / to fit  
**Audi, Nissan**

Regelsonde / Pre cat sensor



Kabel / cables

1

**OXY308.xxx**

Länge / length  
OXY308.037 370 mm  
OXY308.055 550 mm  
OXY308.091 910 mm

passend für / to fit  
**Chevrolet, Mercedes, Opel**

Regelsonde / Pre cat sensor



Kabel / cables

3

**OXY321.xxx**

Länge / length  
OXY321.036 360 mm  
OXY321.060 600 mm  
OXY321.071 710 mm  
OXY321.090 900 mm

passend für / to fit  
**Renault, VAG**

Regelsonde / Pre cat sensor

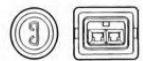

Kabel / cables

3

**OXY333.058**

Länge / length  
OXY333.058 580 mm

passend für / to fit  
**Honda, Volkswagen**

Regelsonde / Pre cat sensor



Kabel / cables  
4

**OXY336.026**

Länge / length  
OXY336.026 260 mm

passend für / to fit  
**Renault**

Regelsonde / Pre cat sensor



Kabel / cables  
3

**OXY356.040**

Länge / length  
OXY356.040 400 mm

passend für / to fit  
**Opel, Suzuki**

Regelsonde / Pre cat sensor



Kabel / cables  
3

**OXY405.030**

Länge / length  
OXY405.030 300 mm

passend für / to fit  
**Mazda**

Regelsonde / Pre cat sensor



Kabel / cables  
4

**OXY406.037**

Länge / length  
OXY406.037 370 mm

passend für / to fit  
**Mercedes**

Regelsonde / Pre cat sensor



Kabel / cables  
4

**OXY410.040**

Länge / length  
OXY410.040 400 mm

passend für / to fit  
**Ford**

Regelsonde / Pre cat sensor



Kabel / cables  
4

**OXY413.040**

Länge / length  
OXY413.040 400 mm

passend für / to fit  
**Ford**

Regelsonde / Pre cat sensor



Kabel / cables  
4

**OXY415.xxx**

Länge / length  
OXY415.057 570 mm  
OXY415.065 650 mm  
OXY415.087 870 mm  
OXY415.100 1000 mm  
OXY415.150 1500 mm

passend für / to fit  
**VAG**

Regelsonde / Pre cat sensor  
OXY415.150 - Diagnosesonde



Kabel / cables  
4

**OXY418.xxx**

	Länge / length	
OXY418.045	450 mm	
OXY418.120	1200 mm	
OXY418.150	1500 mm	

passend für / to fit  
**Citroën, Peugeot**

Regelsonde / Pre cat sensor

Kabel / cables

4



**OXY420.xxx**

	Länge / length		Länge / length
OXY420.037	370 mm	OXY420.220	2200 mm
OXY420.055	550 mm		
OXY420.063	630 mm		
OXY420.104	1040 mm		
OXY420.120	1200 mm		
OXY420.180	1800 mm		

passend für / to fit  
**Citroën, Peugeot, Porsche, Volvo**

Regelsonde / Pre cat sensor

Kabel / cables

4



**OXY422.088**

	Länge / length
OXY422.088	880 mm

passend für / to fit  
**Alfa Romeo, Ferrari, Fiat, Lancia**

Regelsonde / Pre cat sensor

Kabel / cables

4



**OXY423.083**

	Länge / length
OXY423.083	830 mm

passend für / to fit  
**Opel**

Regelsonde / Pre cat sensor

Kabel / cables

4

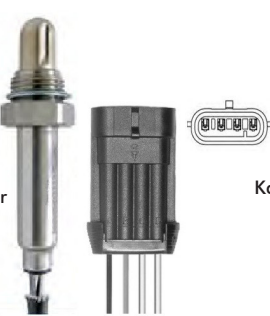

**OXY425.xxx**

	Länge / length
OXY425.097	400 mm
OXY425.117	1170 mm

passend für / to fit  
**Alfa Romeo, Fiat, Lancia**

Regelsonde / Pre cat sensor

Kabel / cables

4



**OXY427.xxx**

	Länge / length
OXY427.055	550 mm
OXY427.084	840 mm
OXY427.150	1500 mm

passend für / to fit  
**BMW**

Regelsonde / Pre cat sensor

Kabel / cables

4



**OXY432.061**

	Länge / length
OXY432.061	610 mm

passend für / to fit  
**Seat, Volkswagen**

Regelsonde / Pre cat sensor

Kabel / cables

4



**OXY442.035**

	Länge / length
OXY442.042	420 mm

passend für / to fit  
**Mercedes**

Diagnosesonde / Post cat sensor

Kabel / cables

4



**OXY445.025**

Länge / length  
 OXY445.025 250 mm

passend für / to fit  
**Renault**

Regelsonde / Pre cat sensor



Kabel / cables  
 4

**OXY451.xxx**

Länge / length  
 OXY451.050 500 mm  
 OXY451.072 720 mm

passend für / to fit  
**Audi, Seat, Skoda, VW**

Regelsonde / Pre cat sensor  
 OXY451.070 - Diagnosesonde



Kabel / cables  
 4

**OXY452.xxx - Planar**

Länge / length  
 OXY452.026 260 mm  
 OXY452.031 310 mm  
 OXY452.082 820 mm  
 OXY452.120 1200 mm

passend für / to fit  
**Audi, Seat, Skoda, VW**

Diagnosesonde / Post cat sensor  
 OXY452.120 - Regelsonde



Kabel / cables  
 4

**OXY453.042 - Planar**

Länge / length  
 OXY453.042 420 mm

passend für / to fit  
**Audi, Seat, Skoda, VW**

Regelsonde / Pre cat sensor



Kabel / cables  
 4

**OXY458.034**

Länge / length  
 OXY458.034 340 mm

passend für / to fit  
**BMW, Land Rover**

Regelsonde / Pre cat sensor



Kabel / cables  
 4

**OXY459.057 - Planar**

Länge / length  
 OXY459.057 570 mm

passend für / to fit  
**Citroën, Fiat, Peugeot, Renault**

Regelsonde / Pre cat sensor



Kabel / cables  
 4

**OXY460.022 - Planar**

Länge / length  
 OXY460.022 220 mm

passend für / to fit  
**Hyundai, Kia**

Regelsonde / Pre cat sensor



Kabel / cables  
 4

**OXY461.050 - Planar**

Länge / length  
 OXY461.050 500 mm

passend für / to fit  
**Mercedes**

Diagnosesonde / Post cat sensor



Kabel / cables  
 4

**OXY462.xxx - Planar**

Länge / length  
OXY462.023 230 mm  
OXY462.033 330 mm

passend für / to fit  
**Toyota**

Regelsonde / Pre cat sensor

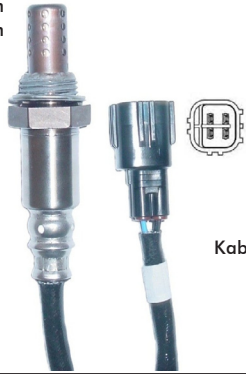

Kabel / cables  
4

**OXY463.036 - Planar**

Länge / length  
OXY463.036 360 mm

passend für / to fit  
**Toyota**

Regelsonde / Pre cat sensor



Kabel / cables  
4

**OXY464.051**

Länge / length  
OXY464.051 510 mm

passend für / to fit  
**Subaru**

Regelsonde / Pre cat sensor



Kabel / cables  
4

**OXY465.059**

Länge / length  
OXY465.059 590 mm

passend für / to fit  
**Mazda**

Regelsonde / Pre cat sensor

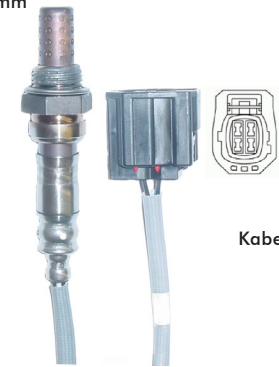

Kabel / cables  
4

**OXY466.050**

Länge / length  
OXY466.050 500 mm

passend für / to fit  
**Suzuki**

Regelsonde / Pre cat sensor



Kabel / cables  
4

**OXY467.088 - Planar**

Länge / length  
OXY467.088 880 mm

passend für / to fit  
**Mazda**

Diagnosesonde / Post cat sensor

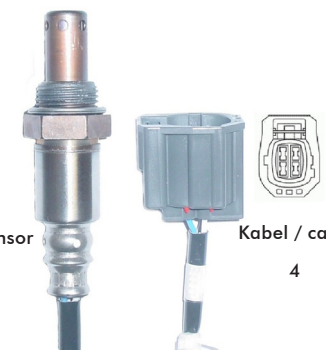

Kabel / cables  
4

**OXY468.xxx - Planar**

Länge / length  
OXY468.047 470 mm  
OXY468.064 640 mm

passend für / to fit  
**Volvo**

Regelsonde / Pre cat sensor

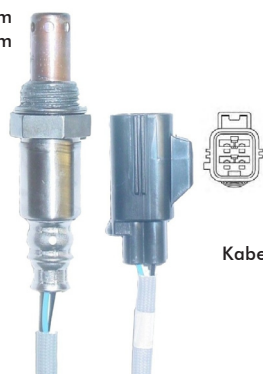

Kabel / cables  
4

**OXY469.037**

Länge / length  
OXY469.037 370 mm

passend für / to fit  
**Nissan**

Diagnosesonde / Post cat sensor

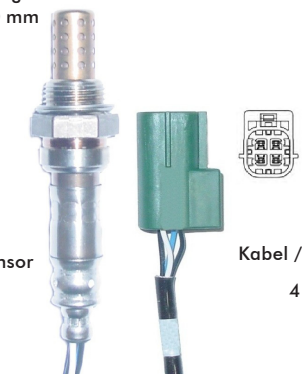

Kabel / cables  
4

**OXY470.xxx - Planar**

Länge / length  
OXY470.030 300 mm  
OXY470.052 520 mm



passend für / to fit  
**Opel**

Diagnosesonde / Post cat sensor  
Regelsonde / Pre cat sensor

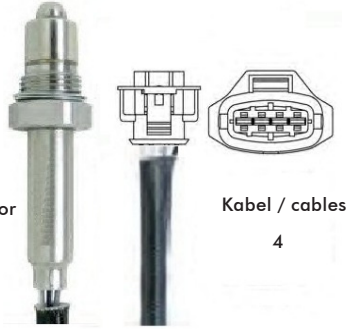

Kabel / cables  
4

**OXY471.045 - Planar**

Länge / length  
OXY471.045 450 mm



passend für / to fit  
**Renault**

Regelsonde / Pre cat sensor

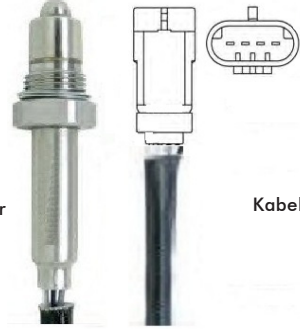

Kabel / cables  
4

**OXY472.xxx - Planar**

Länge / length  
OXY472.045 450 mm  
OXY472.090 900 mm



passend für / to fit  
**Mercedes**

Regelsonde / Pre cat sensor  
Diagnosesonde / Post cat sensor



Kabel / cables  
4

**OXY473.057**

Länge / length  
OXY473.057 570 mm



passend für / to fit  
**Opel**

Regelsonde / Pre cat sensor



Kabel / cables  
4

**OXY474.080 - Planar**

Länge / length  
OXY474.080 800 mm



passend für / to fit  
**Audi, Seat, Skoda, VW**

Diagnosesonde / Post cat sensor

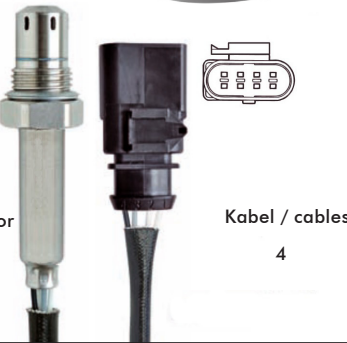

Kabel / cables  
4

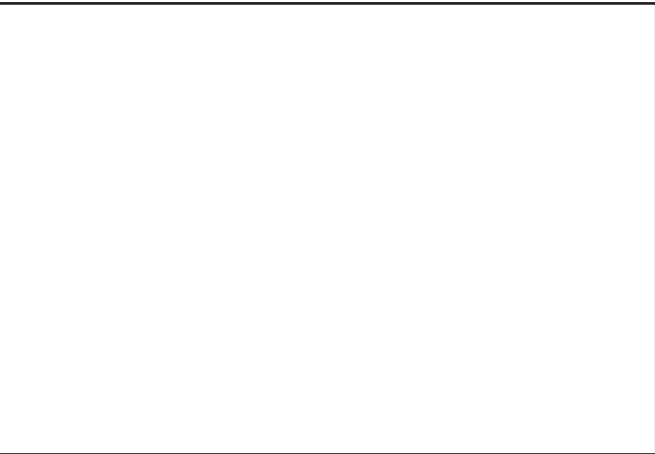
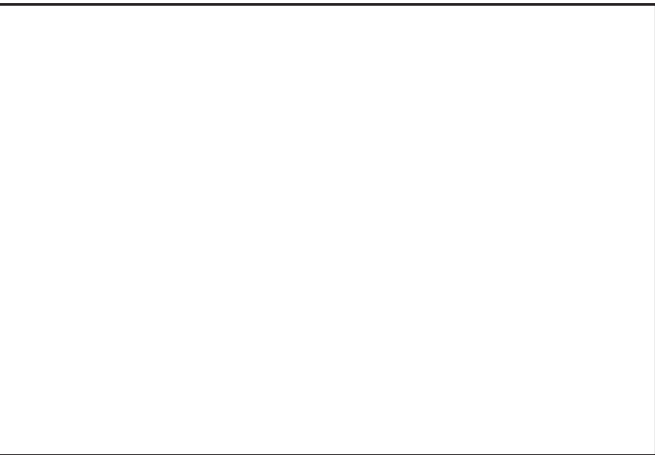

# VERGLEICHSLISTE / CROSS REFERENCE LIST

Referenz-Nr. Reference-No.	BBT-Nr. BBT-No.
-------------------------------	--------------------

<b>Alfa Romeo</b>	<b>BBT</b>
7789741	OXY425.097
7789741	OXY425.097
7798350	OXY425.097
46408444	OXY425.097
46417969	OXY425.097
46426389	OXY425.097
46452598	OXY425.097
46523129	OXY425.097
46523129	OXY425.097
46552313	OXY425.097
46555846	OXY425.097
46823880	OXY425.097

<b>Beru</b>	<b>BBT</b>
-------------	------------

OZH005	OXY418.120
OZH009	OXY333.058
OZH014	OXY410.071
OZH017	OXY321.071
OZH019	OXY308.055
OZH022	OXY415.087
OZH029	OXY418.045
OZH029	OXY418.050
OZH030	OXY427.150
OZH033	OXY308.037
OZH034	OXY418.150
OZH035	OXY422.088
OZH036	OXY427.055
OZH037	OXY321.090
OZH039	OXY427.084
OZH040	OXY308.091
OZH043	OXY432.061
OZH044	OXY321.036
OZH045	OXY410.040
OZH056	OXY425.097
OZH060	OXY003U
OZH061	OXY004U
OZH063	OXY425.097
OZH069	OXY415.087
OZH070	OXY415.057
OZH071	OXY415.035
OZH074	OXY420.037
OZH076	OXY405.030
OZH079	OXY420.104
OZH092	OXY445.025
OZH103	OXY314.041
OZH104	OXY420.063
OZH173	OXY458.034
OZU001	OXY001U
OZU007	OXY002U
OZU015	OXY101.040
OZU021	OXY128.039
OZU022	OXY102.047
OZU024	OXY102.025

<b>BMW</b>	<b>BBT</b>
------------	------------

Referenz-Nr. Reference-No.	BBT-Nr. BBT-No.
-------------------------------	--------------------

11 78 1 247 406	OXY458.034
11 78 1 401 276	OXY427.055
11 78 1 720 537	OXY427.150
11 78 1 720 845	OXY427.055
11 78 1 720 860	OXY427.084
11 78 1 721 125	OXY427.084
11 78 1 725 676	OXY427.055
11 78 1 734 796	OXY427.084
11 78 1 735 680	OXY427.150
11 78 1 739 005	OXY427.055
11 78 1 741 092	OXY427.055
11 78 1 741 666	OXY427.055
11 78 1 742 050	OXY458.034

<b>Bosch</b>	<b>BBT</b>
--------------	------------

0 258 001 026	OXY102.047
0 258 001 027	OXY102.047
0 258 001 035	OXY102.025
0 258 001 038	OXY102.020
0 258 001 051	OXY102.047
0 258 002 013	OXY101.040
0 258 002 014	OXY101.040
0 258 002 034	OXY128.039
0 258 002 049	OXY101.040
0 258 003 009	OXY321.071
0 258 003 017	OXY308.091
0 258 003 052	OXY427.150
0 258 003 061	OXY321.090
0 258 003 064	OXY427.055
0 258 003 067	OXY427.084
0 258 003 069	OXY427.084
0 258 003 074	OXY418.050
0 258 003 075	OXY321.071
0 258 003 075	OXY321.090
0 258 003 078	OXY418.120
0 258 003 082	OXY308.091
0 258 003 083	OXY321.090
0 258 003 086	OXY308.037
0 258 003 090	OXY321.090
0 258 003 108	OXY427.150
0 258 003 109	OXY427.084
0 258 003 115	OXY427.150
0 258 003 123	OXY410.071
0 258 003 127	OXY413.040
0 258 003 139	OXY308.091
0 258 003 160	OXY308.037
0 258 003 165	OXY333.058
0 258 003 169	OXY333.058
0 258 003 181	OXY333.058
0 258 003 189	OXY308.037
0 258 003 195	OXY406.037
0 258 003 201	OXY308.037
0 258 003 203	OXY418.150
0 258 003 215	OXY427.055
0 258 003 216	OXY432.061
0 258 003 218	OXY406.037

Referenz-Nr. Reference-No.	BBT-Nr. BBT-No.
-------------------------------	--------------------

0 258 003 219	OXY427.040
0 258 003 219	OXY427.055
0 258 003 220	OXY427.055
0 258 003 222	OXY422.088
0 258 003 227	OXY413.040
0 258 003 231	OXY427.055
0 258 003 234	OXY321.071
0 258 003 234	OXY321.090
0 258 003 239	OXY418.045
0 258 003 244	OXY427.055
0 258 003 261	OXY427.084
0 258 003 266	OXY432.061
0 258 003 267	OXY432.061
0 258 003 269	OXY432.100
0 258 003 273	OXY333.058
0 258 003 277	OXY356.040
0 258 003 280	OXY321.036
0 258 003 295	OXY321.071
0 258 003 300	OXY308.091
0 258 003 310	OXY427.055
0 258 003 313	OXY321.090
0 258 003 328	OXY406.027
0 258 003 339	OXY410.040
0 258 003 344	OXY321.071
0 258 003 357	OXY427.055
0 258 003 362	OXY348.042
0 258 003 368	OXY405.050
0 258 003 369	OXY420.104
0 258 003 372	OXY405.030
0 258 003 389	OXY413.040
0 258 003 396	OXY321.071
0 258 003 426	OXY427.055
0 258 003 446	OXY308.055
0 258 003 447	OXY308.055
0 258 003 448	OXY308.055
0 258 003 460	OXY427.055
0 258 003 464	OXY420.180
0 258 003 466	OXY425.097
0 258 003 469	OXY425.097
0 258 003 477	OXY458.034
0 258 003 478	OXY415.100
0 258 003 485	OXY410.071
0 258 003 508	OXY321.060
0 258 003 519	OXY415.087
0 258 003 524	OXY314.041
0 258 003 540	OXY418.045
0 258 003 542	OXY415.057
0 258 003 546	OXY415.087
0 258 003 548	OXY415.087
0 258 003 560	OXY425.097
0 258 003 567	OXY418.045
0 258 003 570	OXY425.097
0 258 003 579	OXY425.097
0 258 003 584	OXY415.087
0 258 003 593	OXY420.063
0 258 003 594	OXY420.180

# VERGLEICHSLISTE / CROSS REFERENCE LIST

Referenz-Nr. Reference-No.	BBT-Nr. BBT-No.
0 258 003 611	OXY415.035
0 258 003 630	OXY415.035
0 258 003 630	OXY415.150
0 258 003 644	OXY445.025
0 258 003 667	OXY420.037
0 258 003 668	OXY420.063
0 258 003 669	OXY420.120
0 258 003 672	OXY420.063
0 258 003 673	OXY420.120
0 258 003 687	OXY405.030
0 258 003 690	OXY415.035
0 258 003 698	OXY415.035
0 258 003 705	OXY420.063
0 258 003 713	OXY410.040
0 258 003 714	OXY410.040
0 258 003 716	OXY420.063
0 258 003 717	OXY420.063
0 258 003 718	OXY420.120
0 258 003 759	OXY415.057
0 258 003 763	OXY308.091
0 258 003 772	OXY425.097
0 258 003 779	OXY410.071
0 258 003 813	OXY415.035
0 258 003 814	OXY415.035
0 258 003 815	OXY415.035
0 258 003 842	OXY415.087
0 258 003 872	OXY415.035
0 258 003 995	OXY321.090
0 258 005 049	OXY415.087
0 258 005 062	OXY420.180
0 258 005 079	OXY451.050
0 258 005 081	OXY451.072
0 258 005 097	OXY420.063
0 258 005 099	OXY420.220
0 258 005 113	OXY451.072
0 258 005 191	OXY425.097
0 258 005 192	OXY425.097
0 258 005 256	OXY473.057
0 258 005 660	OXY415.057
0 258 006 021	OXY425.117
0 258 006 023	OXY415.065
0 258 006 159	OXY453.042
0 258 006 163	OXY452.120
0 258 006 171	OXY470.052
0 258 006 272	OXY472.045
0 258 006 475	OXY472.072
0 258 006 499	OXY470.030
0 258 006 501	OXY470.052
0 258 006 661	OXY452.082
0 258 006 749	OXY461.050
0 258 010 038	OXY474.080
<b>Chevrolet</b> <b>BBT</b>	
25 132 535	OXY308.037
25 176 708	OXY308.037
25 176 709	OXY308.037

Referenz-Nr. Reference-No.	BBT-Nr. BBT-No.
25 312 179	OXY308.037
25 315 267	OXY308.037
<b>Daewoo</b> <b>BBT</b>	
25 106 073	OXY101.040
25 162 753	OXY101.040
96 335 925	OXY101.040
<b>Facet</b> <b>BBT</b>	
10.7001	OXY001U
10.7002	OXY002U
10.7003	OXY003U
10.7004	OXY004U
10.7020	OXY425.097
10.7023	OXY425.117
10.7025	OXY321.071
10.7025	OXY427.084
10.7026	OXY321.090
10.7029	OXY321.036
10.7032	OXY427.084
10.7033	OXY432.061
10.7036	OXY418.045
10.7039	OXY422.088
10.7043	OXY333.058
10.7047	OXY102.047
10.7052	OXY415.057
10.7060	OXY308.037
10.7064	OXY418.150
10.7065	OXY420.063
10.7066	OXY420.180
10.7068	OXY420.104
10.7069	OXY420.037
10.7072	OXY101.040
10.7077	OXY454.040
10.7078	OXY308.037
10.7088	OXY415.087
10.7089	OXY473.057
10.7090	OXY451.050
10.7178	OXY451.072
10.7180	OXY451.111
10.7184	OXY427.150
10.7185	OXY427.040
10.7188	OXY427.055
10.7205	OXY405.030
10.7256	OXY413.040
10.7265	OXY308.091
10.7269	OXY445.025
10.7298	OXY458.034
10.7362	OXY451.072
10.7633	OXY469.037
10.7882	OXY420.220
10.7920	OXY452.026
<b>FAE</b> <b>BBT</b>	
77100	OXY102.047
77101	OXY101.040

Referenz-Nr. Reference-No.	BBT-Nr. BBT-No.
77105	OXY321.060
77119	OXY308.091
77126	OXY418.045
77129	OXY445.025
77132	OXY415.065
77134	OXY415.100
77139	OXY451.072
77143	OXY452.120
77144	OXY452.120
77156	OXY473.057
77164	OXY420.063
77184	OXY423.083
77200	OXY451.072
77201	OXY452.031
77243	OXY458.034
77249	OXY472.072
77251	OXY472.045
77254	OXY405.030
77272	OXY442.042
77283	OXY459.057
77337	OXY427.150
77372	OXY420.104
77420	OXY470.030
77427	OXY461.050
<b>Fiat</b> <b>BBT</b>	
142514	OXY422.088
6193040	OXY422.088
7555123	OXY321.090
7555129	OXY321.090
7707638	OXY321.090
46423907	OXY425.117
46426389	OXY425.097
46452598	OXY425.097
46462006	OXY425.117
46519513	OXY425.117
46523499	OXY425.117
46552313	OXY425.097
46555846	OXY425.097
46823880	OXY425.097
60562536	OXY422.088
77311130	OXY422.088
<b>Ford</b> <b>BBT</b>	
1 001 702	OXY410.040
1 010 620	OXY410.040
1 306 213	OXY410.040
3 040 432	OXY413.040
3 517 468	OXY413.040
3 559 458	OXY413.040
4 080 233	OXY413.040
6 847 910	OXY410.040
6 847 911	OXY410.040
6 847 912	OXY410.040
6 983 291	OXY410.040
7 089 574	OXY410.040

# VERGLEICHSLISTE / CROSS REFERENCE LIST

Referenz-Nr. Reference-No.	BBT-Nr. BBT-No.
7 126 156	OXY410.040
7 126 157	OXY410.040
7 325 143	OXY415.150
2S6A-9F472-BB	OXY413.040
2S7A-9G444-BA	OXY413.040
93BB-9F472-AA	OXY410.040
93FB-9F472-AA	OXY410.040
95FB-9F472-BA	OXY410.040
95FB-9F472-CA	OXY410.040
95FB-9F472-DA	OXY410.040
95FB-9F472-DB	OXY410.040
95FB-9F472-EA	OXY410.040
95VM-9F472-CB	OXY415.150
95VW-9F472-DA	OXY415.150
95VW9F472FA	OXY415.087
96FB-9F472-C	OXY410.040
96FB-9F472-CA	OXY410.040
96FB-9F472-DA	OXY410.040
96VB-9F472-BA	OXY410.040
98AB-9G444-BB	OXY413.040
98FB-9F472-BB	OXY413.040
98FB-9F472-CA	OXY413.040
98FB-9F472-DA	OXY413.040
98FB-9G444-CB	OXY413.040
99AB-9G444-BB	OXY413.040
F4AZ-9F472-B	OXY413.040
F4SF-9F472-DA	OXY413.040
F5MF-9F472-DA	OXY413.040
F5MZ-9F472-AA	OXY413.040
F78F-9F472-BA	OXY413.040
XL3F-9F472-AA1	OXY413.040
XR3F-9G444-AA	OXY413.040
XR3F-9G444-AA	OXY413.040
XR3F-9G444-BA	OXY413.040
<b>Honda</b> <b>BBT</b>	
36531-PT3-A12	OXY333.058
89706-22920	OXY356.040
<b>Hyundai</b> <b>BBT</b>	
39210-23500	OXY460.022
39210-23710	OXY460.022
<b>Land Rover</b> <b>BBT</b>	
MHK000210	OXY458.034
<b>Mazda</b> <b>BBT</b>	
JE50-18-861	OXY405.030
JE50-18-861A	OXY405.030
JE50-25-3F6	OXY405.030
KLA6-18-861	OXY405.030
KLA6-25-3F5	OXY405.030
RF7N-18-8G1	OXY467.088
TA37-18-861C	OXY415.065
Z601-18-861A	OXY465.059

Referenz-Nr. Reference-No.	BBT-Nr. BBT-No.
<b>Meat &amp; Doria</b> <b>BBT</b>	
77107	OXY321.090
81002	OXY418.045
81003	OXY418.120
81010	OXY101.040
81011	OXY102.047
81016	OXY308.091
81018	OXY321.036
81021	OXY321.090
81041	OXY423.083
81045	OXY427.055
81053	OXY432.061
81068	OXY420.063
81071	OXY445.025
81091	OXY459.057
81092	OXY405.030
81093	OXY336.026
81096	OXY413.040
81097	OXY452.120
81098	OXY451.072
81098	OXY451.072
81534	OXY458.034
81535	OXY462.033
81538	OXY442.042
81545	OXY415.065
81546	OXY415.100
81572	OXY469.037
81578	OXY420.180
81584	OXY462.023
81595	OXY464.051
81596	OXY463.036
81611	OXY466.050
81626	OXY468.064
81627	OXY465.059
<b>Mercedes</b> <b>BBT</b>	
000 540 51 17	OXY406.037
000 540 81 17	OXY442.042
001 540 05 17	OXY472.045
002 540 06 17	OXY472.072
003 542 82 18	OXY461.050
004 542 07 18	OXY461.050
005 542 24 17	OXY001U
006 542 21 17	OXY001U
009 542 06 17	OXY308.037
A 000 540 81 17	OXY442.042
A 001 540 05 17	OXY472.045
A 002 540 06 17	OXY472.072
A 003 542 82 18	OXY461.050
A 004 542 07 18	OXY461.050
A 009 542 06 17	OXY308.037
<b>NGK</b> <b>BBT</b>	
OTA7H-3C1	OXY423.083
OZA114-A1	OXY405.030
OZA114-V3	OXY415.057

Referenz-Nr. Reference-No.	BBT-Nr. BBT-No.
OZA216-D2	OXY410.040
OZA216-D3	OXY410.071
OZA236-R1	OXY308.037
OZA311-R2	OXY336.026
OZA33-D8	OXY410.071
OZA401-E2	OXY102.047
OZA401-E6	OXY101.040
OZA446-E1	OXY321.071
OZA446-E12	OXY321.036
OZA446-E12	OXY415.087
OZA446-E2	OXY321.090
OZA446-E4	OXY321.090
OZA446-E40	OXY308.055
OZA446-E42	OXY333.058
OZA446-E43	OXY314.041
OZA446-E44	OXY321.090
OZA446-E50	OXY321.071
OZA446-E6	OXY308.091
OZA446-E8	OXY308.037
OZA447-E11	OXY427.055
OZA447-E14	OXY415.087
OZA447-E17	OXY451.050
OZA447-E18	OXY451.072
OZA447-E27	OXY458.034
OZA447-E3	OXY427.150
OZA447-E4	OXY427.040
OZA447-E5	OXY432.061
OZA448-E12	OXY410.040
OZA448-E14	OXY418.045
OZA448-E2	OXY418.050
OZA448-E3	OXY418.150
OZA448-E31	OXY415.057
OZA448-E32	OXY420.037
OZA448-E33	OXY420.063
OZA448-E34	OXY420.104
OZA448-E4	OXY422.088
OZA448-E40	OXY418.120
OZA448-E43	OXY445.025
OZA448-E44	OXY410.040
OZA448-E46	OXY425.117
OZA448-E48	OXY410.071
OZA448-E7	OXY425.097
OZA495-PG2	OXY420.055
OZA510-V6	OXY452.026
OZA527-E7	OXY425.097
OZA55-R1	OXY308.037
OZA572-E12	OXY427.084
OZA572-E4	OXY427.150
OZA659-EE25	OXY452.120
OZA659-EE28	OXY470.052
OZA659-EE4	OXY459.057
OZA659-EE69	OXY470.030
OZA659-EE70	OXY470.052
OZA660-EE7	OXY473.057
OZA683-EE16	OXY472.072
OZA683-EEZ	OXY472.045

# VERGLEICHSLISTE / CROSS REFERENCE LIST

Referenz-Nr. Reference-No.	BBT-Nr. BBT-No.
-------------------------------	--------------------

OZA89-D1 OXY410.040

**Nissan BBT**

22690-06F00 OXY102.020  
 22690-17B00 OXY102.020  
 22690-19B10 OXY102.020  
 22690-F5300 OXY102.020  
 226A0-AU011 OXY469.037

**Opel BBT**

8 55 300 OXY308.091  
 8 55 304 OXY308.091  
 8 55 305 OXY101.040  
 8 55 312 OXY356.040  
 8 55 315 OXY101.040  
 8 55 322 OXY308.055  
 8 55 323 OXY308.055  
 8 55 328 OXY101.040  
 8 55 329 OXY101.040  
 8 55 333 OXY101.040  
 8 55 338 OXY308.091  
 8 55 351 OXY470.052  
 8 55 355 OXY470.030  
 8 55 386 OXY470.052  
 8 55 402 OXY470.030  
 8 55 405 OXY470.052  
 8 55 406 OXY470.052  
 8 55 523 OXY473.057  
 13 103 981 OXY470.052  
 24 420 591 OXY470.030  
 24 420 594 OXY470.052  
 24 432 940 OXY470.052  
 25 164 596 OXY101.040  
 25 327 304 OXY473.057  
 43 000 09 OXY101.040  
 90 009 053 OXY308.091  
 90 231 073 OXY308.091  
 90 325 787 OXY308.091  
 90 350 495 OXY308.091  
 90 397 523 OXY308.091  
 90 409 385 OXY308.091  
 90 411 959 OXY423.083  
 90 448 458 OXY308.091  
 90 499 265 OXY308.055  
 90 499 265 OXY308.055  
 90 499 266 OXY308.055  
 90 499 267 OXY308.055  
 90 509 169 OXY308.055  
 90 509 274 OXY308.055  
 90 509 275 OXY308.055  
 91 021 621 OXY470.030  
 91 29 885 OXY470.052  
 91 29 954 OXY470.052  
 91 93 148 OXY470.030  
 91 99 470 OXY470.052  
 92 02 621 OXY470.030

Referenz-Nr. Reference-No.	BBT-Nr. BBT-No.
-------------------------------	--------------------

93 177 169 OXY470.052  
 93 177 450 OXY470.052  
 93 177 451 OXY470.052  
 93 189 974 OXY473.057  
 97 062 292 OXY356.040

**Porsche BBT**

993 606 126 01 OXY420.104

**PSA BBT**

1628 1G OXY418.150  
 1628 6S OXY420.063  
 1628 9A OXY420.063  
 1628 9V OXY420.063  
 1628 AA OXY420.063  
 1628 CP OXY420.063  
 1628 L6 OXY418.150  
 1628 P1 OXY418.150  
 1628 R9 OXY418.150  
 1628 T2 OXY418.150  
 1628 V4 OXY418.045  
 1628.L4 OXY418.120  
 1828 KN OXY420.055  
 4677 80 OXY459.057  
 93 366 87 0 OXY420.055  
 96 036 827 OXY418.120  
 96 036 857 OXY418.150  
 96 039 269 OXY418.150  
 96 051 883 OXY418.150  
 96 121 278 17 OXY418.045  
 96 127 346 OXY418.045  
 96 138 599 OXY418.150  
 96 138 608 OXY418.150  
 96 138 609 OXY418.150  
 96 229 970 OXY420.063  
 96 229 970 80 OXY420.063  
 96 229 971 OXY420.120  
 96 229 975 OXY459.057  
 96 230 005 80 OXY420.063  
 96 284 479 80 OXY420.037  
 96 284 480 OXY420.063  
 96 284 480 80 OXY420.063  
 96 356 573 OXY420.063  
 96 359 785 OXY459.057

**Renault BBT**

60 01 009 534 OXY321.060  
 77 00 100 713 OXY445.025  
 77 00 260 909 OXY321.060  
 77 00 266 922 OXY321.060  
 77 00 273 715 OXY336.026  
 77 00 708 955 OXY102.020  
 77 00 729 063 OXY102.047  
 77 00 854 136 OXY102.047  
 89 33 002 455 OXY102.047  
 96 35 978 580 OXY459.057

Referenz-Nr. Reference-No.	BBT-Nr. BBT-No.
-------------------------------	--------------------

**Subaru BBT**

18213-60B00 OXY101.040  
 22641AA230 OXY464.051  
 22641AA280 OXY464.051

**Suzuki BBT**

18213-50F00 OXY101.040  
 18213-54D01 OXY466.050  
 18213-63E60 OXY101.040  
 18213-65G41 OXY466.050  
 18213-74F00 OXY101.040  
 18213-76G00 OXY101.040  
 18213-80G12 OXY466.050  
 18213-82010 OXY101.040

**Toyota BBT**

89465-0D040 OXY462.023  
 89465-0D080 OXY462.033  
 89465-0D110 OXY462.033  
 89465-33250 OXY462.023  
 89465-33360 OXY462.023  
 89467-47010 OXY463.036

**VAG BBT**

021 906 265 OXY432.061  
 021 906 265 AB OXY415.065  
 021 906 265 AC OXY415.150  
 021 906 265 AD OXY415.087  
 021 906 265 AF OXY415.087  
 021 906 265 AK OXY415.087  
 021 906 265 AR OXY415.087  
 021 906 265 E OXY415.065  
 021 906 265 T OXY415.087  
 023 906 265 D OXY415.065  
 025 906 265 OXY102.047  
 030 906 265 AB OXY333.058  
 030 906 265 AD OXY415.065  
 030 906 265 BC OXY415.150  
 030 906 265 BF OXY415.065  
 030 906 265 BG OXY415.087  
 030 906 265 BK OXY415.150  
 030 906 265 BM OXY415.087  
 030 906 265 BR OXY415.087  
 030 906 265 BS OXY451.072  
 030 906 265 BT OXY451.072  
 030 906 265 K OXY333.058  
 032 906 265 OXY415.100  
 032 906 265 A OXY415.100  
 032 906 265 B OXY415.100  
 034 906 265 A OXY321.090  
 034 906 265 E OXY321.036  
 034 906 265 F OXY321.090  
 035 906 265 OXY102.047  
 035 906 265 D OXY321.090  
 036 906 265 OXY451.072



## I. Allgemeines

1. Diese Bedingungen gelten für alle Lieferungen, gleichgültig ob Kauf oder Werklieferungsverträge. Wir liefern nur zu diesen Bedingungen, die zugleich auch für sämtliche künftigen Vertragsbeziehungen gelten, auch wenn sie nicht ausdrücklich einbezogen werden.
2. Geschäfts- und Einkaufsbedingungen von Vertragspartnern widersprechen wir hiermit ausdrücklich. Diese werden keinesfalls Vertragsgegenstand. Abweichende Regelungen gelten nur dann, wenn sie von uns schriftlich vor Vertragsabschluss bestätigt worden sind. Wir sind nicht verpflichtet, Vertragsformblättern oder Geschäftsbedingungen von Vertragspartnern förmlich zu widersprechen und zwar auch dann nicht, wenn in diesen Geschäftsbedingungen die Gültigkeit derselben als ausdrückliche Bedingung für den Geschäftsabschluss genannt ist. Wir erklären, ausschließlich aufgrund der vorliegenden Geschäftsbedingungen Verträge abschließen zu wollen.
3. Erfüllungsort für beide Teile ist unser Sitz, Gerichtsstand nach unserer Wahl Ansbach oder Nürnberg.
4. Die Verantwortung für die Auswahl der Produkte und die mit ihnen beabsichtigten Zwecke liegt ausschließlich beim Kunden, es sei denn, wir geben im Einzelfall besondere schriftliche Zusicherungen oder Garantien ab.
5. Wir sind berechtigt, bei erstmaliger Geschäfts- beziehung vor Auftragsübernahme geschäftliche Referenzen anzufordern, insbesondere eine Bank-Verbindung mit einem Ansprechpartner.

## II. Preise

1. Unsere Preise verstehen sich, soweit nicht schriftlich anders vereinbart, ab Weihenzell, ausschließlich Verpackung und Verladung und Transport rein netto, zuzüglich der gesetzlichen Mehrwertsteuer.
2. Wir sind berechtigt, unsere Rechnungen auf elektronischem Wege zu versenden.

## III. Zahlungsstörungen

1. Gerät unser Kunde mit einer Zahlungsverpflichtung in Rückstand, so schuldet er Zinsen in Höhe von 8%-Punkten über dem jeweiligen Basiszinssatz.
2. Wir sind zum Vertragsrücktritt berechtigt, wenn sich die wirtschaftlichen Verhältnisse des Kunden verschlechtern oder schlechte Verhältnisse bekanntwerden. Ebenso, wenn Zahlungsverpflichtungen länger als zwei Wochen trotz Mahnung nicht erfüllt werden. Ist Zahlung in Teilbeträgen gestattet, so wird der Rest sofort fällig, wenn Zahlungstermine um mehr als zwei Wochen überschritten werden. Bei Abrufaufträgen sind wir berechtigt, vom nicht erfüllten Teil der Abrufvereinbarung zurückzutreten und Schadensersatz wegen Nichterfüllung der gesamten Abrufvereinbarung zu verlangen, wenn der Kunde mit der Abnahme auch nur eines Teils der vereinbarten Mengen in Verzug gerät. Gleiches gilt, wenn der Kunde mit der Bezahlung bisheriger Lieferungen in Verzug und nicht in der Lage ist, weitere Leistungen nur gegen Vorauszahlungen oder Sicherheitsleistung entgegenzunehmen.
3. Aufrechnung mit bestrittenen und nicht rechtskräftigen Gegenansprüchen ist nicht statthaft. Gleiches gilt für das Zurückbehaltungsrecht.

## IV. Schadensersatz

Erfüllt der Kunde einen Vertrag nicht oder können wir von unserem Rücktrittsrecht Gebrauch machen, so erhalten wir als Entschädigung unseres entgangenen Gewinns einen pauschalen Schadensersatz in Höhe von 25% des vereinbarten Preises zuzüglich des Entgelts für bereits erbrachte Arbeitsleistungen und Materialverbrauch ohne Nachweis, unbeschadet des Rechts beider Seiten, einen höheren oder niedrigeren Schaden nachzuweisen.

## V. Eigentumsvorbehalt

1. Sämtliche Lieferungen bleiben bis zur vollständigen Zahlung unserer sämtlichen Forderungen aus der Geschäftsbeziehung unser Eigentum. Sofern im Einzelfall eine Übersicherung von mehr als 25% eintreten sollte, verpflichten wir uns zur Freigabe von Gegenständen oder Forderungen nach Auswahl des Kunden.
2. Veräußerung und Verarbeitung von Vorbehaltsware ist zulässig. Insoweit tritt uns der Kunde die daraus entstehenden Forderungen gegen Dritte bereits jetzt ab. Der Kunde ist widerruflich berechtigt, die Forderungen einzuziehen.
3. Der Eigentumsvorbehalt berechtigt uns im Falle des Zahlungsverzuges zur sofortigen Wiederinbesitznahme oder Geltendmachung der Rechte aus der Abtretung. Der Kunde verzichtet auf die Einwendung der unzulässigen Eigenmacht und ermächtigt uns von vornherein zum freihändigen Verkauf der Gegenstände auf seine Kosten.
4. Wird die Vorbehaltsware vom Käufer verarbeitet, so wird vereinbart, dass die Verarbeitung im Namen und für Rechnung des Verkäufers als Hersteller erfolgt und der Verkäufer unmittelbar das Eigentum oder – wenn die Verarbeitung aus Stoffen mehrerer Eigentümer erfolgt oder der Wert der verarbeitenden Sache höher ist als der Wert der Vorbehaltsware – das Miteigentum (Bruchteilseigentum) an der neu geschaffenen Sache im Verhältnis des Werts der Vorbehaltsware zum Wert der neu geschaffenen Sache erwirbt. Für den Fall, dass kein solcher Eigentumserwerb beim Verkäufer eintreten sollte, überträgt der Käufer bereits jetzt sein künftiges Eigentum oder – im oben genannten Verhältnis – Miteigentum an der neu geschaffenen Sache zur Sicherheit an den Verkäufer.

Wird die Vorbehaltsware mit anderen Sachen zu einer einheitlichen Sache verbunden oder untrennbar vermischt und ist eine der anderen Sachen als Hauptsache anzusehen, so überträgt der Verkäufer, soweit die Hauptsache ihm gehört, dem Käufer anteilig das Miteigentum an der einheitlichen Sache in dem in Satz 1 genannten Verhältnis.

## VI. Übergabe

1. Der Versand erfolgt stets auf Rechnung und Gefahr des Kunden. Mit der Übergabe an den Spediteur/Frachtführer geht die Gefahr über, spätestens beim Verlassen unseres Geschäftsgrundstücks.
2. Bei Export der gekauften Ware ist der Kunde verpflichtet, die notwendigen Export- und Zollbewilligungen, sowie sonstigen Einfuhrunterlagen auf seine Kosten zu beschaffen. Wir haften nicht für die Zulässigkeit der Ausfuhr der Ware und deren Übereinstimmung mit besonderen rechtlichen und technischen Vorschriften des Importlandes.
3. Eine Versicherung der Ware für den Transport erfolgt durch uns nur bei Vorliegen eines Auftrags des Kunden.

## VII. Haftung

1. Der Kunde ist verpflichtet, bei Meidung des vollständigen Rechtsverlustes die Vollständigkeit und Mangelfreiheit der Ware sofort nach Entgegennahme zu überprüfen und Beanstandungen schriftlich spätestens am nächsten Tage mitzuteilen. Bei berechtigten Mängelrügen haben wir das Recht, die Ware zurückzunehmen und unverzüglich Ersatz zu leisten.
2. Abweichungen in der Beschaffenheit der gelieferten Gegenstände können nicht beanstandet werden, sofern sie handelsüblich und für den vorgesehenen Gebrauch nicht erheblich sind. Jegliche Eingriffe von außen, die mit einem geltend gemachten Mangel im Zusammenhang stehen, heben die Gewährleistung auf.
3. Wir können wegen Nichterfüllung oder Verzugs nur in Anspruch genommen werden, wenn uns Vorsatz oder grobe Fahrlässigkeit nachgewiesen werden kann. Gleiches gilt auch für Mangelfolgeschäden, für die wir ansonsten nicht haften. Ist uns Ersatz oder Nachbesserung, zu der wir ebenfalls berechtigt sind, in angemessener Frist nicht möglich, so kann der Kunde Rückgängigmachung des Vertrages verlangen. Die Haftungsbeschränkung gilt nicht bei Personenschäden oder wenn es sich um eine Verletzung vertragswesentlicher Pflichten handelt. Vertragswesentlich sind die Verpflichtung zur rechtzeitigen Lieferung sowie Beratungs-, Schutz- und Obhutspflichten, die dem Kunden die vertragsgemäße Verwendung des Liefergegenstandes ermöglichen sollen oder den Schutz von Leib oder Leben von Personal des Kunden oder den Schutz von dessen Eigentum vor erheblichen Schäden bezwecken. Im Falle einer Haftung für einfache Fahrlässigkeit ist unsere Ersatzpflicht für Sachschäden und daraus resultierende weitere Vermögensschäden auf einen Betrag in Höhe der derzeitigen Deckungssumme unserer Produkthaftpflichtversicherung oder sonstigen Haftpflichtversicherung beschränkt, auch wenn es sich um eine Verletzung vertragswesentlicher Pflichten handelt.
4. Ansprüche gegen uns, gleichgültig aus welchem Rechtsgrund, mit Ausnahme bei Personenschäden verjähren insoweit innerhalb von 12 Monaten, soweit nicht eine kürzere gesetzliche Verjährung gilt.
5. Unser Kunde ist gehalten, gelieferte Gegenstände vor einer Weiterverarbeitung sorgfältig zu überprüfen und stellt uns deshalb von Produkthaftpflichtansprüchen frei.
6. Rücksendungen dürfen nur nach vorheriger Einwilligung durch BBT erfolgen.

## VIII. Lieferungen

1. Wir streben termingerechte Auslieferung an. Liefertermine sind allerdings nur verbindlich, wenn sie schriftlich kalendermäßig vereinbart sind. Können wir gleichwohl nicht liefern, so ist uns zwei Wochen nach Ablauf des Liefertermins eine schriftliche Nachfrist zu setzen, die mindestens einen Monat betragen muß.
2. Eine angemessene Lieferzeitverlängerung tritt immer bei unvorhergesehenen Hindernissen, auch bei Änderungs- oder Ergänzungswünschen des Kunden, die die Art des Produkts oder den Umfang der Lieferung betreffen, ein.

## IX. Rechtswahl

Sämtliche Rechtsbeziehungen unterstehen ausschließlich deutschem Recht. Die Anwendung internationaler Rechtsvorschriften, insbesondere die Anwendung des UN-Kaufrechts ist ausgeschlossen.

## X. Sonstiges

1. Wenn in diesen Geschäftsbedingungen Schriftform genannt ist, so ist darunter auch Telefax und E-Mail (mit Eingangs- oder Lesebestätigung) zu sehen.
2. Es wird vereinbart, dass mündliche Nebenabreden zu Verträgen nur wirksam sind, wenn sie schriftlich bestätigt werden. Ein Verzicht auf die Einhaltung dieser Vorschrift setzt Schriftform voraus.
3. Wir behalten uns vor, nicht in deutscher und englischer Sprache abgegebene Willenserklärungen als nicht erfolgt anzusehen.
4. Sollte eine oder mehrere Bestimmungen dieser Bedingungen ganz oder teilweise unwirksam oder nichtig sein oder werden, so wird dadurch die Wirksamkeit des Bedingungswerks im Übrigen nicht berührt. Der Kunde und wir sind in diesem Fall gehalten, die betreffende Bestimmung durch eine wirksame Regelung zu ersetzen, die dem gewollten wirtschaftlichen Zweck am nächsten kommt. Gleiches gilt im Falle einer Lücke.

## I. General

1. These conditions subject to all deliveries, no matter if purchase or order acceptance ex works. We only deliver to these conditions, which are at the same time valid for all further business agreements, even if they are not included especially.
2. We herewith contradict business and purchasing conditions of contract partners. These will under no circumstances become object of agreement. Deviations from our contracts only apply if confirmed by us in writing before conclusion of contract. We are not obliged to contradict the contract forms or general terms and conditions of the customer, even not if the validity of the terms and conditions is mentioned as an express condition for the business transaction. We (herewith) declare that we exclusively intend to conclude contracts on the basis of the present terms and conditions.
3. Place of settlement for both parties is our place, place of jurisdiction is, chosen by us, Ansbach or Nürnberg.
4. The responsibility for the selection of goods and the intended purpose for them is up to the customer. In single cases we give special written assurances or guarantees.
5. We are entitled to request business references at the first business contact before acceptance of order. This means in particular bank details and a contact person.

## II. Prices

1. If not agreed otherwise in writing, our prices are valid net ex Weihenzell, exclusive lost for packing, despatch and transport.
2. We are entitled to send our invoices by electronic means.

## III. Delays in Payment

1. If our customer gets in delays with payment obligations, he owes us interests of 8 % over the basic rate of interest at that time.
2. We are entitled to resign from the contract if our customers' economic circumstances deteriorate or worse circumstances get public, just as if payment obligation is not fulfilled within 2 weeks despite of reminder. If payment is allowed in partial amounts, the rest will get due immediately after payment dates are exceeded more than 2 weeks. If the customer gets in delay with the purchase, even of a part, of the agreed quantities of orders on call, we are entitled to resign from the not fulfilled part of the agreement on call and to demand compensations because of not accomplishing the complete agreement on call. The same applies if the customer gets in delay with the payment of previous deliveries and is not able to accept further services only against advance payments and purchaser security.
3. Settlements in account with not agreed, unclear or not valid demands are not permitted.

## IV. Compensation

If the customer does not fulfil a contract or if we can use our right to resign from the contract, we get a lump sum of 25 % from the agreed price for compensation of our lost profit in addition to already effected labour cost and material used, without proof not having the right of both sides to proof a higher or lesser damage.

## V. Reservation of Ownership

1. Goods supplied remain our property until payment of all our demands under the business contract with the customer has been received.
2. Sale and manufacturing of goods with reservation is admitted. In so far the customer withdraws the arising demands against third parties already now. The customer is revocably entitled to draw in the demands.
3. The reservation of property entitles us to the immediate re-taking of possession in case of payment delays. The customer resigns the objection and authorizes us from the beginning to sell the goods on his cost.
4. If the goods subject to reservation are processed by the customer then it is agreed that the processing is done in the name and for account of the supplier as manufacturer and the supplier shall acquire the ownership directly or – if the processing is of material from several owners or if the value of the processed item exceeds that of the goods subject to reservation – the co-ownership (fractional ownership) of the newly created item in the ratio of the goods subject to reservation to the value of the newly created goods. In case that no such acquisition of property should occur for the supplier, the customer shall henceforth transfer his future property or – in the above relation – co-ownership of the newly created item to the supplier's security. If the goods subject to reservation are combined or inseparably mixed with other goods to a single item and if one of the other can be considered as the main item, then the supplier shall, insofar as the main item belongs to him, transfer the co-ownership proportionally to the customer of the uniform item in the ratio stated in sentence 1.

## VI. Transfer

1. Goods are always forwarded at purchaser's risk and charge. With transfer to the forwarder the risk changes sides, at latest leaving our business site. In case the purchased goods shall be exported, the customer shall be obliged to obtain the necessary authorisations for export and customs as well as other importing documents at his own expenses. We are not liable for the admissibility of the exportation of the goods and its accordance with particular legal and technical regulations of the importing country.
2. An insurance for the goods during transport is only made by us if we have been received an order by the customer.

## VII. Responsibility

1. The customer is obliged to check completeness and condition of goods immediately after receipt and to inform us in writing about claims on the next day at latest, otherwise warranty expires. If notices of defects are justified, we have the right to take the goods back and supply a replacement immediately.
2. Discrepancies in the condition of the delivered goods cannot be objected as long as they are customary and for the intended purpose not considerable. Manipulation, which is in a relation with a notified claim, liability also expires.
3. Claim for non-accomplishment or delay is only possible, if we can be proved intention or coarse negligence. This also applies to damages in sequence to deficiencies. If we are not in a position to supply replacement or improvement – to which we are also entitled – within a reasonable period of time, the customer can require the cancellation of the contract. The limitation of liability shall not apply to personal injury or to violation of essential contractual duties. The obligation to deliver in time is essential as well as the duties to advice, protect and care which shall enable the customer to use the delivery item according to agreement or contribute to the protection of life and limb of the customer's personnel or to the protection of its title against substantial damage. Our liability to pay compensation for property damage and further resulting financial losses is limited to an amount of the current sum insured in the event of liability for simple negligence, even if it is a violation of essential contractual duties.
4. Claims against us no matter the cause become prescriptive after 12 month with exception of personal injury.
5. Our customer is obliged to check delivered goods carefully before manufacturing or using them. Therefore we are released from product liability claims.
6. No merchandise is to be returned to us without agreement.

## VIII. Deliveries

1. We endeavour to deliver on time. Delivery dates are only binding if they are agreed with a firm date in writing. If we are nevertheless not able to deliver, a written set term of at least 4 weeks has to be agreed. This has to take place 2 weeks after expiration of the delivery date.
2. A suitable extension of the delivery time always takes place because of unexpected obstacles, force majeure and also due to alterations or additional requirements of the customer which concern the type of the products and the scope of the delivery.

## IX. Choice of law

All legal relations are under the jurisdiction of German law. The application of international legislations is excluded, in particular the application of the UN Sales Convention.

## X. Others

1. If written form is mentioned in these terms and conditions, fax and e-mail is meant by this as well (including acknowledgement of receipt and read confirmation).
2. It is agreed that all verbal agreements besides to the contracts are only effective, if they are confirmed in writing. A renunciation to fulfil this regulation has to be done in writing.
3. We reserve the right to consider declaratory acts, which are not given in German or English language, as not taken place.
4. Should one or more provisions of this agreement be totally or partially legally ineffective or invalid, the validity of the terms and conditions shall thereby not be affected. In this case, the customer and us are obliged to replace the concerning provision with an effective regulation which come closest to the intended economic purpose. The same applies in the event of a gap.

**IGNITION COILS**

**CAMSHAFT - CRANKSHAFT SENSORS**

**IGNITION CABLE SETS**

**MASS AIR FLOW SENSORS**

**MAP SENSORS**

**FUEL SUPPLY UNITS**

**OXYGEN SENSORS**

3...2...1...Ignition