

# BBT

Automotive Components GmbH  
German Technology

KURBEL- & NOCKENWELLESENSOREN

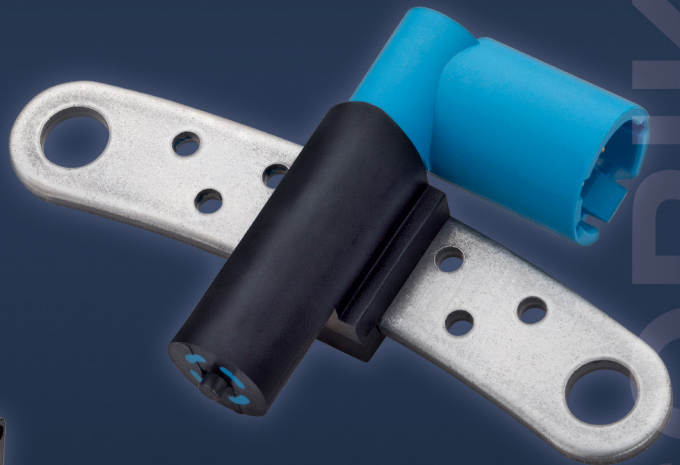

CRANKSHAFT – CAMSHAFT SENSORS

SENSORS

SENSORIK

# BBT Automotive Components GmbH

*BBT* hat sich im Verlauf von 2 Jahrzehnten durch Qualität, Wettbewerbsfähigkeit, Kompetenz und Zuverlässigkeit im Ersatzteilmarkt als starke Marke etabliert.

*BBT* ist ständig im Einsatz, um Kunden freundlich und fachkundig zu betreuen sowie mit aktuellen Produktinformationen zu versorgen. Dabei stehen termingerechte Lieferungen und einwandfreie Qualität immer im Vordergrund.



*BBT* is a strong and well established brand which kept its focus on quality, reliability and competitiveness in the automotive aftermarket during a history of two decades.

*BBT* is fully committed to provide customers with an excellent service of experts and detailed information about all products. Priority is the product quality along with deliveries on time at competitive prices to serve our customers needs.



## Inhaltsverzeichnis

### List of Contents

Seite / page	4 - 5	.....	Produktinformation / product information
Seite / page	6 - 120	.....	Anwendungsliste / application list
Seite / page	121 - 142	.....	Abbildungen / pictures
Seite / page	143 - 152	.....	Vergleichsliste / cross reference list
Seite / page	153 - 154	.....	AGB's / General Sales term and conditions

## Allgemeine Informationen

### General information

Durch die ständige Weiterentwicklung des Programms ist es möglich, dass sich unsere Produktdaten ändern. BBT Automotive Components GmbH behält sich das Recht vor, Ausführung und Artikelnummern der in diesem Katalog gezeigten Produkte jederzeit und ohne Ankündigung zu ändern. Alle Rechte vorbehalten.

Die Gegenüberstellung von BBT Artikelnummern zu Fahrzeugherstellern oder zu Herstellern von anderen Marken dient ausschließlich zu Vergleichszwecken. Technische Unterschiede sind bauart- und herstellerbedingt möglich, wofür eine Gewährleistung ausgeschlossen ist. Verbindlich bei der Bestellung ist jeweils die BBT Artikelnummer.

Due to continued research and development of our program, BBT Automotive Components GmbH reserves the right to modify all product data without further notice. All rights reserved.

The cross-reference of BBT article numbers to car manufacturers or manufacturers of other brands is only for comparative purposes. Technical differences may occur in relation to construction and manufacturer, therefore warranty can not be granted. When placing the order, the BBT article number is binding.

Bei Rückfragen stehen wir Ihnen gerne jederzeit zur Verfügung.  
In case of queries do not hesitate to contact us.



#### *Headquarters*

BBT Automotive Components GmbH  
Gewerbering 12  
91629 Weihenzell  
Germany  
info@bbt-automotive.de  
Phone: +49(0)9802 - 95211 0  
Fax: +49(0)9802 - 95211 95



# Kurbel- & Nockenwellensensoren | Einführung

## Nockenwellensensor

Der Nockenwellensensor arbeitet entweder nach dem Induktiv Prinzip oder wie beim Kurbelwellensensor nach dem Hall-Prinzip. Er tastet einen Zahnkranz ab der sich auf der Nockenwelle befindet.

Durch die Rotation des Zahnkranzes ändert sich die Hall Frequenz des Sensors. Die Hall Spannung des im Sensorkopf befindlichen Hall-IC bleibt konstant. Diese sich ändernde Frequenz wird an das Steuergerät geleitet und dort ausgewertet um die erforderlichen Daten festzustellen.

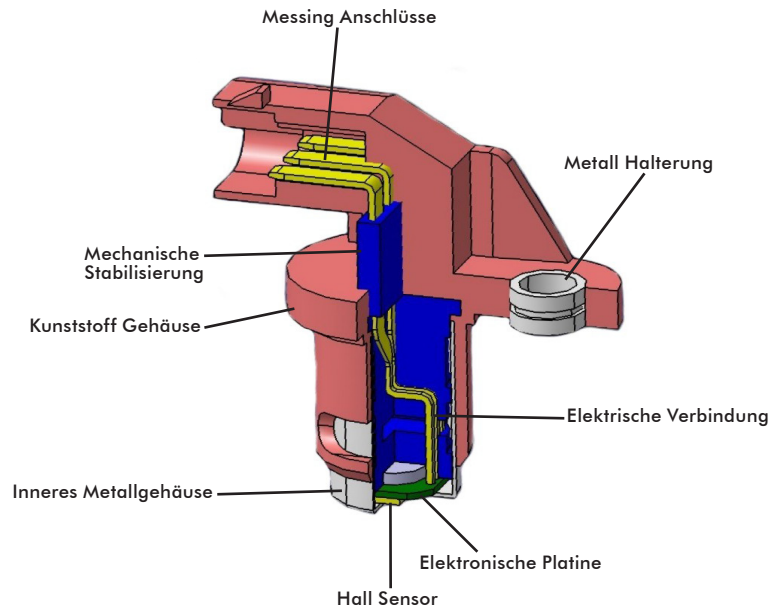

## Anstiegszeit, CSS402

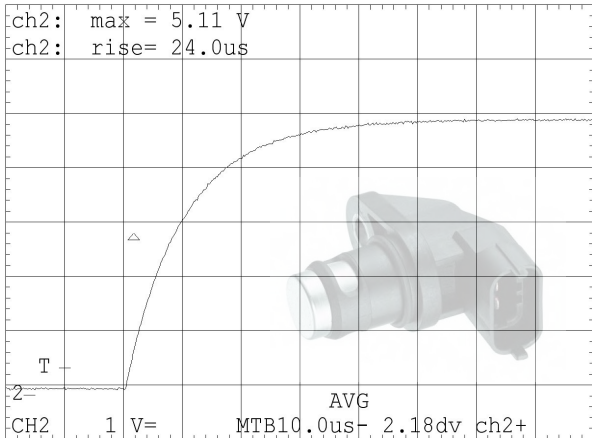

## Kurbelwellensensor

Der Kurbelwellensensor misst die Motordrehzahl, dieser besteht aus einem Dauermagneten und einer Induktionsspule mit Weicheisenkern. Als Impulsgeber wird ein Zahnkranz am Schwungrad angebracht. Zwischen Induktiveber und Zahnkranz befindet sich nur ein kleiner Luftspalt.

Der magnetische Fluss durch die Spule hängt davon ab, ob dem Sensor eine Lücke oder ein Zahn gegenübersteht. Ein Zahn bündelt den Streufluss des Magneten, eine Lücke dagegen schwächt den Magnetfluss. Wenn sich das Schwungrad und somit der Zahnkranz dreht, wird durch jeden einzelnen Zahn eine Magnetfeldänderung bewirkt. Die Änderung des Magnetfeldes erzeugt in der Spule eine Induktionsspannung.

Die Anzahl der Impulse pro Zeiteinheit sind ein Maß für die Drehzahl des Schwungrades. Durch bewusste Zahnluken im Zahnkranz kann das Steuergerät auch die momentane Stellung (Position) des Motors erkennen. Die Drehzahl des Motors ist eine Hauptsteuergröße für die Gemisch Berechnung und für die Zündverstellung.



# Camshaft & Crankshaft Sensors | introduction

## Camshaft Sensor

The camshaft sensor works either on the principle of induction or on the Hall principle just like the crankshaft sensor. The sensor scans a gear rim located on the camshaft.

As the gear rim rotates, the sensor's Hall frequency changes. The Hall tension of the Hall IC located in the sensor head remains constant. This changing frequency is transmitted to the control unit for evaluation in order to determine the required data.

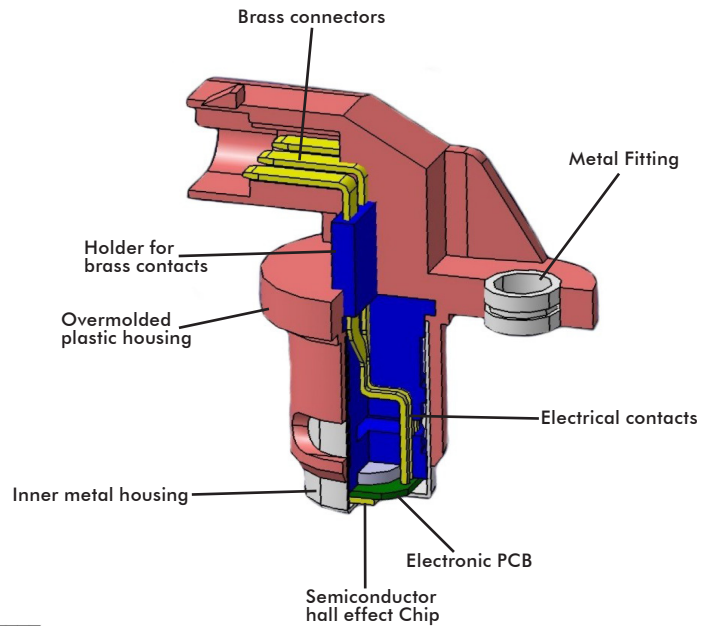

## Rise time, CSS402

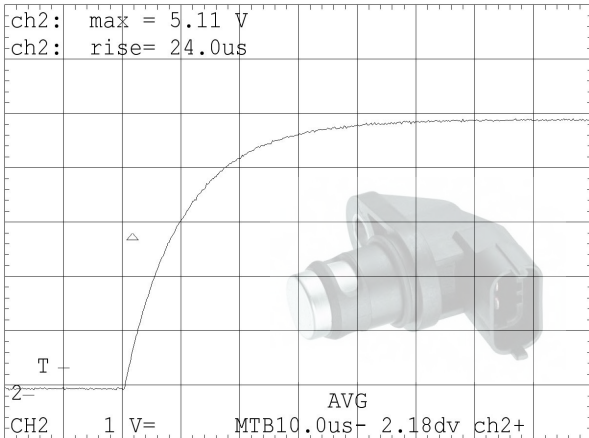

## Crankshaft Sensor

The crankshaft sensor measures the rotational speed of the motor. It consists of a permanent magnet and an induction coil with a soft-iron core. A gear rim is fitted to the fly wheel as a pulse transmitter. There is only a small air gap between the inductive transmitter and the gear rim.

The magnetic flow through the coil depends on whether there is a gap or a gear tooth opposite the sensor. A gear tooth will focus the magnet's leakage flux while a gap reduces the magnetic flux. As the fly wheel and thus the gear rim rotates, each individual gear tooth causes a change in the magnetic field. These changes in the magnetic field create induction voltage inside the coil.

The rotational speed of the fly wheel can be measured by the number of impulses per time unit. Deliberate gaps in the gear rim enable the control unit to detect the current position of the motor as well. The motor's rotational speed is the main control factor for determining the mixture and for ignition advance.

Typ Type	Motornummer Engine-No.	Baujahr Year	Zyl. Cyl.	KW	Kurbelwellen- sensor Crankshaft S.	Nocken- wellensensor Camshaft S.
<b>Alfa Romeo</b>						
145 1.4 i.e. 16V T.S.	AR 33503	12.96 - 01.01	4	76	CSS1000	---
145 1.6 i.e. 16V T.S.	AR 38201, AR 67601	12.96 - 01.01	4	88	CSS1000	---
145 1.8 i.e. 16V T.S.	AR 38401, AR 67601	12.96 - 12.98	4	103	CSS1000	---
145 2.0 i.e. 16V T.S.	AR 67204	10.95 - 01.01	4	110	CSS1000	---
146 1.6 i.e. 16V T.S.	AR 38201, AR 67601	11.96 - 01.01	4	88	CSS1000	---
146 1.8 i.e. 16V T.S.	AR 38401, AR 67106	11.96 - 01.01	4	103	CSS1000	---
146 2.0 16V T.S.	AR 67204	10.95 - 01.01	4	110	CSS1000	---
147 1.9 JTD 16V	192 A5.000	11.02 - 03.10	4	103	CSS1300	CSS1301
147 1.9 JTDM 16V	937 A5.000	07.05 - 03.10	4	110	CSS1300	CSS1301
147 1.9 JTDM 16V	937 A6.000	06.08 - 03.10	4	125	CSS1300	CSS1301
155 1.6 16V T.S.	AR 67601	05.96 - 12.97	4	88	CSS1000	---
155 1.7 16V T.S.	AR 67106	05.96 - 12.97	4	103	CSS1000	---
155 2.0 16V T.S.	AR 67204	03.95 - 12.97	4	110	CSS1000	---
156 1.6 16V T. Spark	AR 32104, AR 67601	09.97 - 09.05	4	88	CSS1000	---
156 1.9 JTD 16V	192 A5.000	11.02 - 09.05	4	103	CSS1300	CSS1301
156 2.4 JTD	841 G.000	10.03 - 09.05	5	129	CSS1300	CSS1301
156 Sportwagon 1.6 16V T. Spark	AR 32104, AR 67601	05.00 - 05.06	4	88	CSS1000	---
156 Sportwagon 1.9 JTD 16V	192 A5.000	11.02 - 05.06	4	103	CSS1300	CSS1301
156 Sportwagon 1.9 JTD 16V Q4	937 A5.000	07.04 - 05.06	4	110	CSS1300	CSS1301
156 Sportwagon 2.4 JTD	841 G.000	10.03 - 05.06	5	129	CSS1300	CSS1301
159 1.8 TBi	939 B1.000	05.09 - 11.11	4	147	CSS1317	CSS716
159 1.9 JTDM 16V	937 A8.000, 939 A8.000	09.05 - 11.11	4	100	CSS1300	CSS1301
159 1.9 JTDM 16V	939 A2.000	09.05 - 11.11	4	110	CSS1300	CSS1301
159 1.9 JTS	939 A6.000	09.05 - 11.11	4	118	---	CSS720
159 1.9 JTS	939 A6.000	09.05 - 11.11	4	118	CSS1300	CSS1301
159 2.2 JTS	939 A5.000	09.05 - 11.11	4	136	---	CSS720
159 2.4 JTDM	939 A3.000	09.05 - 11.11	5	147	CSS1300	CSS1301
159 2.4 JTDM	939 A9.000	05.07 - 11.11	5	154	CSS1300	CSS1301
159 3.2 JTS Q4	939 A.000	12.05 - 11.11	6	191	CSS1300	CSS1301
159 Sportwagon 1.8 TBi	939 B1.000	05.09 - 11.11	4	147	CSS1317	CSS716
159 Sportwagon 1.9 JTS	939 A6.000	03.06 - 11.11	4	118	---	CSS720
159 Sportwagon 2.2 JTS	939 A5.000	03.06 - 11.11	4	136	---	CSS720
166 2.4 JTD	841 G.000, 841 H.000	10.03 - 06.07	5	129	CSS1300	CSS1301
166 2.4 JTD	841 M.000	07.06 - 06.07	5	132	CSS1300	CSS1301
166 2.4 JTD	841 M.000, 936 B.000	07.05 - 06.07	5	136	CSS1300	CSS1301
Brera 1.8 TBi	939 B1.000	05.09 - 06.10	4	147	CSS1317	---
Brera 2.2 JTS	939 A5.000	01.06 - 06.10	4	136	---	CSS720
Brera 2.4 JTDM 20V	939 A3.000	01.06 - 06.10	5	147	CSS1300	CSS1301
Brera 2.4 JTDM 20V	939 A9.000	05.07 - 06.10	5	154	CSS1300	CSS1301
Giulietta 1.6 JTDM	940 A3.000	04.10 ->	4	77	CSS1300	---
Giulietta 1.8 TBi	940 A1.000	04.10 ->	4	173	CSS1317	CSS716
Giulietta 1.8 TBi	960 A1.000	09.13 ->	4	177	CSS1317	CSS716
Giulietta 2.0 JTDM	940 A4.000	04.10 ->	4	125	CSS1300	---
Giulietta 2.0 JTDM	940 A5.000	04.10 ->	4	103	CSS1300	---
Giulietta 2.0 JTDM	940 A7.000	04.10 ->	4	120	CSS1300	---
GT 1.9 JTD	937 A5.000	11.03 - 09.10	4	110	CSS1300	CSS1301
GT 1.9 JTD	937 A6.000	05.08 - 09.10	4	125	CSS1300	CSS1301
GTV 2.0 16V T. Spark	AR 16201, AR 32310	06.95 - 10.05	4	110	CSS1000	---
Mito 0.9	312 A2.000	07.11 ->	2	63	CSS1321	---
Mito 1.3 JTDM	199 A3.000	09.08 ->	4	66	CSS1303	CSS716
Mito 1.3 JTDM	199 B1.000	10.09 ->	4	70	CSS1303	CSS716
Mito 1.3 JTDM	199 B4.000	01.11 ->	4	62	CSS1303	---
Mito 1.3 MultiJet	199 B8.000	12.13 ->	4	59	---	CSS716
Mito 1.4	955 A1.000	03.11 ->	4	57	CSS1318	---
Mito 1.4	955 A9.000	05.11 ->	4	51	CSS1318	---
Mito 1.6 JTDM	198 A2.000	09.08 ->	4	88	CSS1300	CSS1301
Mito 1.6 JTDM	955 A4.000	09.08 ->	4	85	CSS1300	CSS1301
Spider 1.8 TBi	939 B1.000	05.09 - 06.10	4	147	CSS1317	CSS716

Typ Type	Motornummer Engine-No.	Baujahr Year	Zyl. Cyl.	KW	Kurbelwellen- sensor Crankshaft S.	Nocken- wellensensor Camshaft S.
Spider 2.0 16V T. Spark	AR 16201, AR 32310	06.95 - 04.05	4	110	CSS1000	---
Spider 2.2 JTS	939 A5.000	03.06 - 06.10	4	136	---	CSS720
Spider 2.4 JTDM	939 A3.000	04.07 - 06.10	4	147	CSS1300	CSS1301
Spider 2.4 JTDM	939 A3.000	03.08 - 06.10	4	154	CSS1300	CSS1301
<b>Audi</b>						
80 2.6	ABC	07.92 - 12.94	6	110	CSS312	CSS317
80 2.6 quattro	ABC	06.92 - 12.94	6	110	---	CSS317
80 2.8	AAH	09.91 - 12.94	6	128	CSS312	CSS317
80 2.8 quattro	AAH	09.91 - 12.94	6	128	CSS312	CSS317
90 2.0 20V	NM	08.89 - 07.91	5	118	CSS312	---
90 2.3 E 20V	7A	04.90 - 07.91	5	123	CSS312	---
90 2.3 E 20V	7A	08.88 - 07.91	5	125	CSS312	---
90 2.3 E 20V quattro	7A	04.90 - 09.91	5	123	CSS312	---
90 2.3 E 20V quattro	7A	06.88 - 09.91	5	125	CSS312	---
100 2.2 E Turbo quattro	MC	08.86 - 11.90	5	121	CSS312	---
100 2.2 Turbo	MC	08.86 - 11.90	5	121	CSS312	---
100 2.4 D	AAS	12.90 - 06.94	5	60	CSS312	---
100 2.5 TDI	AAT, ABD	12.90 - 06.94	5	85	CSS312	---
100 2.6	ABC	03.92 - 06.94	6	110	CSS312	CSS317
100 2.6 quattro	ABC	04.92 - 06.94	6	110	CSS312	CSS317
100 2.8 E	AAH	12.90 - 06.94	6	128	CSS312	CSS317
100 2.8 E quattro	AAH	12.90 - 06.94	6	128	CSS312	CSS317
200 2.2 Turbo	MC	08.85 - 09.91	5	121	CSS312	---
200 2.2 Turbo	MC	02.88 - 12.90	5	147	CSS312	---
A1 1.0 TFSI	CHZB	03.15 ->	3	70	---	CSS308
A1 1.0 TFSI	CHZE	01.16 ->	3	60	---	CSS308
A1 1.2 TFSI	CBZA	05.10 ->	4	63	CSS322	CSS300
A1 1.4 TDI	CUSB	11.14 ->	3	66	---	CSS331
A1 1.4 TFSI	CAVG, CTHG, CTJA	01.11 ->	4	136	CSS322	CSS300
A1 1.4 TFSI	CAXA, CNVA	05.10 ->	4	90	CSS322	CSS300
A1 1.4 TFSI	CPTA	04.12 ->	4	103	CSS322	CSS308
A1 1.4 TFSI	CZCA, CZDB	11.14 ->	4	92	---	CSS308
A1 1.4 TFSI	CZEA	11.14 ->	4	110	---	CSS308
A1 1.6 TDI	CAYB	03.11 ->	4	66	CSS322	CSS331
A1 1.6 TDI	CAYC	05.10 ->	4	77	---	CSS331
A1 1.6 TDI	CXMA	11.14 ->	4	85	---	CSS331
A1 1.8 TFSI	DAJB	02.15 ->	4	141	---	CSS308
A1 2.0 TDI	CFHB	05.12 ->	4	100	CSS322	CSS331
A1 2.0 TDI	CFHD	09.11 ->	4	105	CSS322	CSS331
A1 S1 quattro	CWZA	03.14 ->	4	170	---	CSS308
A1 Sportback 1.0 TFSI	CHZB	03.15 ->	3	70	---	CSS308
A1 Sportback 1.0 TFSI	CHZE	01.16 ->	3	60	---	CSS308
A1 Sportback 1.2 TFSI	CBZA	01.12 ->	4	63	CSS322	CSS300
A1 Sportback 1.4 TDI	CUSB	11.14 ->	3	66	---	CSS331
A1 Sportback 1.4 TFSI	CAVG, CTHG, CTJA	11.11 ->	4	136	CSS322	CSS300
A1 Sportback 1.4 TFSI	CAXA, CNVA	11.11 ->	4	90	CSS322	CSS300
A1 Sportback 1.4 TFSI	CPTA	04.12 ->	4	103	CSS322	CSS308
A1 Sportback 1.4 TFSI	CZCA	11.14 ->	4	92	---	CSS308
A1 Sportback 1.4 TFSI	CZEA	11.14 ->	4	110	---	CSS308
A1 Sportback 1.6 TDI	CAYB	11.11 ->	4	66	CSS322	CSS331
A1 Sportback 1.6 TDI	CAYC	11.11 ->	4	77	---	CSS331
A1 Sportback 1.6 TDI	CXMA	11.14 ->	4	85	---	CSS331
A1 Sportback 1.8 TFSI	DAJB	02.15 ->	4	141	---	CSS308
A1 Sportback 2.0 TDI	CFHB	05.12 ->	4	100	CSS322	CSS331
A1 Sportback 2.0 TDI	CFHD	09.11 ->	4	105	---	CSS331
A1 Sportback S1 quattro	CWZA	03.14 ->	4	170	---	CSS308
A2 1.2 TDI	ANY	03.01 - 08.05	3	45	---	CSS328
A2 1.4	AUA, BBY	02.00 - 08.05	4	55	---	CSS307

Typ Type	Motornummer Engine-No.	Baujahr Year	Zyl. Cyl.	KW	Kurbelwellen- sensor Crankshaft S.	Nocken- wellensensor Camshaft S.
A2 1.4 TDI	AMF, BHC	02.00 - 08.05	3	55	---	CSS328
A2 1.4 TDI	ATL	11.03 - 08.05	3	66	---	CSS328
A2 1.6 FSI	BAD	05.02 - 08.05	4	81	---	CSS300
A3 1.0 TFSI	CHZD	07.16 ->	3	85	---	CSS308
A3 1.2 TFSI	CJZA	02.13 ->	4	77	---	CSS308
A3 1.2 TFSI	CYVB	05.14 ->	4	81	---	CSS308
A3 1.2 TSI	CBZB	04.10 - 08.12	4	77	CSS322	CSS300
A3 1.4 TFSI	CAXC, CMSA	09.07 - 08.12	4	92	CSS322	CSS300
A3 1.4 TFSI	CMBA, CXSA	04.12 ->	4	90	---	CSS308
A3 1.4 TFSI	CPTA	03.13 ->	4	103	---	CSS308
A3 1.4 TFSI	CXSB, CZCA	05.14 ->	4	92	---	CSS308
A3 1.4 TFSI	CZEA	05.14 ->	4	110	---	CSS308
A3 1.6	AEH, AKL, APF	09.96 - 08.00	4	74	CSS311	CSS316
A3 1.6	AKL, APF, AEH	09.96 - 05.03	4	74	CSS325	---
A3 1.6	AVU, BFQ	08.00 - 05.03	4	75	CSS325	---
A3 1.6	AVU, BFQ	08.00 - 05.03	4	75	CSS311	CSS316
A3 1.6	BGU, CCSA, BSF, CMXA, BSE	05.03 - 08.12	4	75	CSS325	---
A3 1.6	BGU	05.03 - 08.12	4	75	---	CSS303
A3 1.6 E-Power	CMXA	01.11 - 08.12	4	75	---	CSS303
A3 1.6 FSI	BAG, BLP	08.03 - 09.07	4	85	---	CSS300
A3 1.6 TDI	CAYB	05.09 - 08.12	4	66	CSS322	---
A3 1.6 TDI	CLHA	10.12 ->	4	77	---	CSS331
A3 1.6 TDI	CRKB, CXXB, DBKA	09.13 ->	4	81	---	CSS331
A3 1.8	AGN, APG	09.96 - 05.03	4	92	CSS311	CSS318
A3 1.8 quattro	AGN	08.98 - 05.03	4	92	CSS311	CSS318
A3 1.8 S3 quattro	AMK, APY	03.99 - 04.02	4	154	CSS311	CSS318
A3 1.8 S3 quattro	BAM	10.01 - 05.03	4	165	---	CSS318
A3 1.8 T	AGU, AQA, ARZ, AUM	12.96 - 05.03	4	110	CSS311	CSS318
A3 1.8 T	AJQ, APP, ARY, AUQ	12.98 - 05.03	4	132	CSS311	CSS318
A3 1.8 T quattro	AGU, AQA, ARX	12.96 - 05.03	4	110	CSS311	CSS318
A3 1.8 T quattro	AJQ, ARY	10.98 - 05.03	4	132	CSS311	CSS318
A3 1.8 T quattro	ARX, AQA, AGU	12.96 - 05.03	4	110	CSS325	---
A3 1.8 TFSI	BYT, BZB, CDAA	11.06 - 08.12	4	118	CSS313	CSS324
A3 1.8 TFSI	CJSA	04.12 ->	4	132	---	CSS308
A3 1.8 TFSI quattro	CDAA	07.08 - 08.12	4	118	CSS313	CSS324
A3 1.8 TFSI quattro	CJSB	08.12 ->	4	132	---	CSS308
A3 1.9 TDI	AGR, ALH	09.96 - 07.01	4	66	CSS315	---
A3 1.9 TDI	AHF, ASV	08.97 - 07.01	4	81	CSS315	---
A3 1.9 TDI	ASZ	08.00 - 05.03	4	96	---	CSS328
A3 1.9 TDI	AXR, ATD	10.03 - 05.03	4	74	---	CSS328
A3 1.9 TDI	BKC	05.03 - 05.10	4	77	---	CSS302
A3 1.9 TDI	BXE, BKC, BLS	05.03 - 05.10	4	77	---	CSS329
A3 1.9 TDI quattro	ASZ	08.00 - 05.03	4	96	---	CSS328
A3 2.0 FSI	AXW, BLR, BLX, BLY, BMB, BVY	05.03 - 06.08	4	110	CSS326	CSS302
A3 2.0 TDI	AZV	05.03 - 08.12	4	100	---	CSS302
A3 2.0 TDI	AZV, CBAA, CFFA	05.03 - 08.12	4	100	CSS322	---
A3 2.0 TDI	BMM	06.05 - 06.08	4	103	---	CSS329
A3 2.0 TDI	BMN, CBBB, CFGB	03.06 - 08.12	4	125	CSS322	CSS330
A3 2.0 TDI	BUY	06.06 - 06.08	4	120	---	CSS330
A3 2.0 TDI	CBAA, CFFA, AZV	05.03 - 08.12	4	100	---	CSS330
A3 2.0 TDI	CRBD, CRLC	05.13 ->	4	100	---	CSS331
A3 2.0 TDI	CRFA	01.13 ->	4	81	---	CSS331
A3 2.0 TDI	CRFC	09.12 ->	4	105	---	CSS331
A3 2.0 TDI	CUNA	05.13 ->	4	135	---	CSS331
A3 2.0 TDI	CRLB, CRBC, CRUA, DEJA	04.12 ->	4	110	---	CSS331
A3 2.0 TDI 16V	BKD	05.03 - 08.12	4	103	---	CSS302
A3 2.0 TDI 16V	BKD, CBAB, CFFB, CLJA	05.03 - 08.12	4	103	CSS322	CSS330
A3 2.0 TDI 16V quattro	BKD	08.04 - 08.12	4	103	---	CSS302
A3 2.0 TDI 16V quattro	BKD, CBAB, CFFB	08.04 - 08.12	4	103	CSS322	CSS330

Typ Type	Motornummer Engine-No.	Baujahr Year	Zyl. Cyl.	KW	Kurbelwellen- sensor Crankshaft S.	Nocken- wellensensor Camshaft S.
A3 2.0 TDI quattro	AZV	05.03 - 06.08	4	100	---	CSS330
A3 2.0 TDI quattro	BMM	01.06 - 06.08	4	103	---	CSS329
A3 2.0 TDI quattro	BMN, CBBB, CFGB	03.06 - 08.12	4	125	CSS322	CSS330
A3 2.0 TDI quattro	CRBC	10.12 ->	4	110	---	CSS331
A3 2.0 TDI quattro	CUNA	12.12 ->	4	135	---	CSS331
A3 2.0 TFSI	AXX	09.04 - 08.12	4	147	---	CSS302
A3 2.0 TFSI	AXX, BWA, CAWB, CCZA	09.04 - 08.12	4	147	CSS325	CSS324
A3 2.0 TFSI quattro	AXX	09.04 - 08.12	4	147	---	CSS302
A3 2.0 TFSI quattro	AXX, BWA, CCZA	09.04 - 08.12	4	147	CSS325	CSS324
A3 3.2 V6 quattro	BDB, BMJ, BUB	07.03 - 05.09	6	184	---	CSS323
A3 Cabriolet 1.6	BSE	09.08 - 05.10	4	75	CSS325	---
A3 Cabriolet 1.6 TDI	CRKB, CXXB	02.14 ->	4	81	---	CSS331
A3 Cabriolet 1.8 TFSI	BZB, CDAA	04.08 - 05.13	4	118	CSS313	---
A3 Cabriolet 1.8 TFSI	BZB, CDAA	04.08 - 05.13	4	118	---	CSS320
A3 Cabriolet 1.9 TDI	BLS	04.08 - 10.09	4	77	---	CSS329
A3 Cabriolet 2.0 TDI	CRLB	10.13 ->	4	110	---	CSS331
A3 Cabriolet 2.0 TDI	CRLC	10.13 ->	4	100	---	CSS331
A3 Cabriolet 2.0 TDI	CUNA	05.14 ->	4	135	---	CSS331
A3 Cabriolet 2.0 TDI quattro	CRLB	03.14 ->	4	110	---	CSS331
A3 Cabriolet 2.0 TDI quattro	CUNA	05.14 ->	4	135	---	CSS331
A3 Cabriolet 2.0 TFSI	CAWB, CCZA	04.08 - 05.13	4	147	CSS313	---
A3 Limousine 1.0 TFSI	CHZD	07.16 ->	3	85	---	CSS308
A3 Limousine 1.2 TFSI	CJZA	10.13 ->	4	77	---	CSS308
A3 Limousine 1.2 TFSI	CYVB	05.14 ->	4	81	---	CSS308
A3 Limousine 1.4 TFSI	CMBA, CXSA	09.13 ->	4	90	---	CSS308
A3 Limousine 1.4 TFSI	CPTA	05.13 ->	4	103	---	CSS308
A3 Limousine 1.4 TFSI	CXSB, CZCA	09.13 ->	4	92	---	CSS308
A3 Limousine 1.4 TFSI	CZEA	05.14 ->	4	110	---	CSS308
A3 Limousine 1.6 TDI	CLHA	09.13 ->	4	77	---	CSS331
A3 Limousine 1.6 TDI	CRKB, CXXB, DBKA	05.14 ->	4	81	---	CSS331
A3 Limousine 1.6 TDI quattro	CXXB	05.15 ->	4	81	---	CSS331
A3 Limousine 1.8 TFSI	CNSB	11.13 ->	4	125	---	CSS308
A3 Limousine 1.8 TFSI quattro	CJSB	11.13 ->	4	132	---	CSS308
A3 Limousine 2.0 TDI	CRBD, CRLC	09.13 ->	4	100	---	CSS331
A3 Limousine 2.0 TDI	CRFC	10.13 ->	4	105	---	CSS331
A3 Limousine 2.0 TDI	CUNA	05.14 ->	4	135	---	CSS331
A3 Limousine 2.0 TDI	CRLB, CRBC, CRUA, DEJA	05.13 ->	4	110	---	CSS331
A3 Limousine 2.0 TDI	DEJB, CRFA	05.13 ->	4	81	---	CSS331
A3 Limousine 2.0 TDI quattro	CRLB, CRBC	10.13 ->	4	110	---	CSS331
A3 Limousine 2.0 TDI quattro	CUNA	05.14 ->	4	135	---	CSS331
A3 Limousine S3 quattro	CJXB	10.13 ->	4	206	---	CSS308
A3 Limousine S3 quattro	CJXC	10.13 ->	4	221	---	CSS308
A3 Limousine S3 quattro	CJXD, DJHB	08.16 ->	4	213	---	CSS308
A3 Limousine S3 quattro	CJXF	05.14 ->	4	210	---	CSS308
A3 Limousine S3 quattro	CJXG, DJHA	06.16 ->	4	228	---	CSS308
A3 S3 quattro	AMK, APY, AUL	03.99 - 04.02	4	154	CSS325	---
A3 S3 quattro	BAM	10.01 - 05.03	4	165	CSS325	---
A3 S3 quattro	BHZ, CDLA	11.06 - 08.12	4	195	CSS325	CSS302
A3 S3 quattro	BZC, CDLC	02.07 - 08.12	4	188	CSS325	CSS302
A3 S3 quattro	CJXB	02.13 ->	4	206	---	CSS308
A3 S3 quattro	CJXC	11.12 ->	4	221	---	CSS308
A3 S3 quattro	CJXD, DJHB	07.16 ->	4	213	---	CSS308
A3 S3 quattro	CJXF	05.14 ->	4	210	---	CSS308
A3 S3 quattro	CJXG, DJHA	06.16 ->	4	228	---	CSS308
A3 Sportback 1.0 TFSI	CHZD	07.16 ->	3	85	---	CSS308
A3 Sportback 1.2 TFSI	CJZA	05.13 ->	4	77	---	CSS308
A3 Sportback 1.2 TFSI	CYVB	05.14 ->	4	81	---	CSS308
A3 Sportback 1.2 TSI	CBZB	04.10 - 08.12	4	77	CSS322	CSS300
A3 Sportback 1.4 TFSI	CAXC, CMSA	09.07 - 08.12	4	92	CSS322	CSS300

Type	Motornummer Engine-No.	Baujahr Year	Zyl. Cyl.	KW	Kurbelwellen- sensor Crankshaft S.	Nocken- wellensensor Camshaft S.
A3 Sportback 1.4 TFSI	CMBA, CXSA	09.12 ->	4	90	---	CSS308
A3 Sportback 1.4 TFSI	CPTA	03.13 ->	4	103	---	CSS308
A3 Sportback 1.4 TFSI	CXSB, CZCA	05.14 ->	4	92	---	CSS308
A3 Sportback 1.4 TFSI	CZEA	05.14 ->	4	110	---	CSS308
A3 Sportback 1.4 TFSI e-tron	CUKB, CXUA	05.14 ->	4	110	---	CSS308
A3 Sportback 1.4 TFSI g-tron	CPWA	11.13 ->	4	81	---	CSS308
A3 Sportback 1.6	BGU, CCSA, BSF, CMXA, BSE	09.04 - 03.13	4	75	CSS325	CSS303
A3 Sportback 1.6 E-Power	CMXA	01.11 - 03.13	4	75	---	CSS303
A3 Sportback 1.6 FSI	BLP	09.04 - 09.07	4	85	---	CSS300
A3 Sportback 1.6 TDI	CAYB	05.09 - 03.13	4	66	CSS322	---
A3 Sportback 1.6 TDI	CAYC	05.09 - 03.13	4	77	CSS322	---
A3 Sportback 1.6 TDI	CLHA	10.12 ->	4	77	---	CSS331
A3 Sportback 1.6 TDI	CRKB, CXXB, DBKA	09.13 ->	4	81	---	CSS331
A3 Sportback 1.6 TDI quattro	CXXB	05.15 ->	4	81	---	CSS331
A3 Sportback 1.8 TFSI	BYT, BZB, CDAA	11.06 - 03.13	4	118	CSS313	---
A3 Sportback 1.8 TFSI	BYT, BZB, CDAA	11.06 - 03.13	4	118	---	CSS324
A3 Sportback 1.8 TFSI	CJSA, CJSB	09.12 ->	4	132	---	CSS308
A3 Sportback 1.8 TFSI quattro	CDAA	07.08 - 03.13	4	118	CSS313	CSS324
A3 Sportback 1.8 TFSI quattro	CJSB	05.13 ->	4	132	---	CSS308
A3 Sportback 1.9 TDI	BXE, BKC, BLS	09.04 - 05.10	4	77	---	CSS329
A3 Sportback 2.0 FSI	BLY, BMB, BLR, AXW, BVZ, BZY	09.04 - 06.08	4	110	CSS326	---
A3 Sportback 2.0 TDI	BMM	06.05 - 06.08	4	103	---	CSS330
A3 Sportback 2.0 TDI	BMN, CBBB, CFGB	03.06 - 03.13	4	125	CSS322	---
A3 Sportback 2.0 TDI	BUY	06.06 - 06.08	4	120	---	CSS330
A3 Sportback 2.0 TDI	CRBD, CRLC	05.13 ->	4	100	---	CSS331
A3 Sportback 2.0 TDI	CRFC	03.13 ->	4	105	---	CSS331
A3 Sportback 2.0 TDI	CUNA	05.13 ->	4	135	---	CSS331
A3 Sportback 2.0 TDI	CRLB, CRBC, CRUA, DEJA	09.12 ->	4	110	---	CSS331
A3 Sportback 2.0 TDI	DEJB, CRFA	05.13 ->	4	81	---	CSS331
A3 Sportback 2.0 TDI 16V	BKD, CBAB, CFFB, CLJA	09.04 - 03.13	4	103	CSS322	CSS330
A3 Sportback 2.0 TDI 16V quattro	BKD, CBAB, CFFB	11.05 - 03.13	4	103	CSS322	CSS330
A3 Sportback 2.0 TDI quattro	BMM	01.06 - 06.08	4	103	---	CSS329
A3 Sportback 2.0 TDI quattro	BMN, CBBB, CFGB	03.06 - 03.13	4	125	CSS322	CSS330
A3 Sportback 2.0 TDI quattro	CRLB, CRBC	02.13 ->	4	110	---	CSS331
A3 Sportback 2.0 TDI quattro	CUNA	05.13 ->	4	135	---	CSS331
A3 Sportback 2.0 TFSI	AXX, BW, CCZA	09.04 - 03.13	4	147	---	CSS324
A3 Sportback 2.0 TFSI	AXX, BWA, CAWB, CBFA, CCZA	09.04 - 03.13	4	147	CSS325	CSS324
A3 Sportback 2.0 TFSI quattro	BWA, BPY, AXX, CCZA	09.04 - 03.13	4	147	CSS325	---
A3 Sportback 2.5 RS3 quattro	CEPA	01.11 - 12.12	5	250	---	CSS324
A3 Sportback 3.2 V6 quattro	BMJ, BUB	09.04 - 05.09	6	184	---	CSS323
A3 Sportback RS3 quattro	CZGB	03.15 ->	5	270	---	CSS331
A3 Sportback S3 quattro	BHZ, CDLA	06.08 - 03.13	4	195	CSS325	---
A3 Sportback S3 quattro	CDLC	07.08 - 03.13	4	188	CSS325	---
A3 Sportback S3 quattro	CJXB	05.13 ->	4	206	---	CSS308
A3 Sportback S3 quattro	CJXC	11.12 ->	4	221	---	CSS308
A3 Sportback S3 quattro	CJXD, DJHB	07.16 ->	4	213	---	CSS308
A3 Sportback S3 quattro	CJXF	05.14 ->	4	210	---	CSS308
A3 Sportback S3 quattro	CJXG, DJHA	06.16 ->	4	228	---	CSS308
A4 1.4 TFSI	CVNA	08.15 ->	4	110	---	CSS308
A4 1.6	ADP,AHL, ANA, ARM	01.95 - 07.00	4	74	CSS311	CSS316
A4 1.6	ALZ	11.00 - 12.04	4	75	---	CSS303
A4 1.6	ALZ	11.04 - 06.08	4	75	---	CSS303
A4 1.8	ADR, APT, ARG, AVV	01.95 - 11.00	4	92	---	CSS318
A4 1.8 quattro	ADR, APT, ARG	01.95 - 11.00	4	92	---	CSS318
A4 1.8 T	AEB, ANB, APU, ARK, AWT	01.95 - 11.00	4	110	---	CSS318
A4 1.8 T	AVJ	11.00 - 07.02	4	110	---	CSS318
A4 1.8 T	BEX	11.02 - 12.04	4	140	---	CSS318
A4 1.8 T	BFB	07.02 - 12.04	4	120	---	CSS318
A4 1.8 T	BFB, BKB	07.02 - 12.04	4	120	---	CSS318

Typ Type	Motornummer Engine-No.	Baujahr Year	Zyl. Cyl.	KW	Kurbelwellen- sensor Crankshaft S.	Nocken- wellensensor Camshaft S.
A4 1.8 T quattro	AEB, ANB, APU, ARK, AWT	01.95 - 11.00	4	110	---	CSS318
A4 1.8 T quattro	AVJ	11.00 - 07.02	4	110	---	CSS318
A4 1.8 T quattro	BEX	11.02 - 12.04	4	140	---	CSS318
A4 1.8 T quattro	BFB	07.02 - 12.04	4	120	---	CSS318
A4 1.8 T quattro	BFB	07.02 - 12.04	4	120	---	CSS318
A4 1.8 TFSI	CAAB, CCUA, CDHB	11.07 ->	4	118	---	CSS324
A4 1.8 TFSI	CABA, CDHA	01.08 - 12.15	4	88	CSS333	---
A4 1.8 TFSI	CABA, CDHA	01.08 - 12.15	4	88	CSS313	---
A4 1.8 TFSI	CABA, CDHA	01.08 ->	4	88	---	CSS324
A4 1.8 TFSI	CABB, CDHB	11.07 - 03.12	4	118	CSS333	---
A4 1.8 TFSI	CABB, CDHB	11.07 - 03.12	4	118	CSS313	---
A4 1.8 TFSI	CJEB	11.11 - 12.15	4	125	---	CSS308
A4 1.8 TFSI quattro	CDHB	09.08 - 03.12	4	118	CSS333	---
A4 1.8 TFSI quattro	CDHB	09.08 - 03.12	4	118	CSS313	CSS324
A4 1.8 TFSI quattro	CJEB	11.11 - 12.15	4	125	---	CSS308
A4 2.0	ALT	11.00 - 12.04	4	96	---	CSS318
A4 2.0	ALT	11.00 - 12.04	4	96	---	CSS318
A4 2.0 FSI	AWA	07.02 - 12.04	4	110	CSS310	CSS302
A4 2.0 TDI	BNA, BRP	11.04 - 06.08	4	100	---	CSS330
A4 2.0 TDI	BRD	06.06 - 06.08	4	125	---	CSS330
A4 2.0 TDI	BVA	06.06 - 06.08	4	120	---	CSS330
A4 2.0 TDI	BVF	11.05 - 11.06	4	93	---	CSS330
A4 2.0 TDI	BVG	09.05 - 09.06	4	89	---	CSS330
A4 2.0 TDI	CAGA, CJCA, CMEA, CMFA	11.07 - 12.15	4	105	CSS333	---
A4 2.0 TDI	CAGA, CMEA	11.07 - 12.15	4	105	CSS322	---
A4 2.0 TDI	CAGB, CJCB	11.07 ->	4	100	CSS322	---
A4 2.0 TDI	CAGB, CJCB, CSUB	11.07 - 12.15	4	100	CSS333	---
A4 2.0 TDI	CAGC	06.08 - 12.15	4	88	CSS322	---
A4 2.0 TDI	CAGC, CJCC	06.08 - 12.15	4	88	CSS333	---
A4 2.0 TDI	CAHA	01.08 - 03.12	4	125	CSS333	---
A4 2.0 TDI	CAHA	01.08 - 03.12	4	125	CSS322	---
A4 2.0 TDI	CAHB	08.08 - 12.15	4	120	CSS322	---
A4 2.0 TDI	CAHB, CGLD, CNHC	08.08 - 12.15	4	120	CSS333	---
A4 2.0 TDI	CGLC, CMGB	11.11 - 12.15	4	130	---	CSS331
A4 2.0 TDI	CJCD, CMFB	05.13 - 12.15	4	110	CSS322	---
A4 2.0 TDI	CJCD, CMFB, CSUA	05.13 - 12.15	4	110	---	CSS331
A4 2.0 TDI	CNHA	09.13 - 12.15	4	140	---	CSS331
A4 2.0 TDI 16V	BLB, BRE	11.04 - 06.08	4	103	---	CSS330
A4 2.0 TDI quattro	BRD	06.06 - 06.08	4	125	---	CSS330
A4 2.0 TDI quattro	BVA	06.06 - 06.08	4	120	---	CSS330
A4 2.0 TDI quattro	CAGA	11.08 ->	4	105	CSS322	---
A4 2.0 TDI quattro	CAGA, CJCA	11.08 - 12.15	4	105	CSS333	---
A4 2.0 TDI quattro	CAHA	01.08 - 03.12	4	125	CSS333	---
A4 2.0 TDI quattro	CAHA	01.08 ->	4	125	CSS322	---
A4 2.0 TDI quattro	CGLC	11.11 - 12.15	4	130	---	CSS331
A4 2.0 TDI quattro	CJCD	05.13 - 12.15	4	110	CSS322	---
A4 2.0 TDI quattro	CJCD, CSUA	05.13 - 12.15	4	110	---	CSS331
A4 2.0 TDI quattro	CNHA	09.13 - 12.15	4	140	---	CSS331
A4 2.0 TFSI	BGB	11.04 - 06.08	4	147	---	CSS302
A4 2.0 TFSI	BPG, BWT, BGB, BWE	11.04 - 06.08	4	147	CSS325	---
A4 2.0 TFSI	BPJ, BYK	10.06 - 06.08	4	125	CSS325	---
A4 2.0 TFSI	BPJ, BYK	10.06 - 06.08	4	125	---	CSS302
A4 2.0 TFSI	BUL	06.05 - 06.08	4	162	CSS325	CSS302
A4 2.0 TFSI	CAEA, CDNB, CFKA	06.08 - 12.15	4	132	CSS333	---
A4 2.0 TFSI	CAEA, CDNB, CFKA	06.08 - 12.15	4	132	CSS313	---
A4 2.0 TFSI	CAEB, CDNC	06.08 - 05.13	4	155	CSS333	---
A4 2.0 TFSI	CAEB, CDNC	06.08 - 05.13	4	155	CSS313	---
A4 2.0 TFSI	CAED	05.13 - 12.15	4	162	---	CSS324
A4 2.0 TFSI	CNCD	05.13 - 12.15	4	165	---	CSS308

Typ Type	Motornummer Engine-No.	Baujahr Year	Zyl. Cyl.	KW	Kurbelwellen- sensor Crankshaft S.	Nocken- wellensensor Camshaft S.
A4 2.0 TFSI	CNCD	05.13 - 12.15	4	165	---	CSS324
A4 2.0 TFSI	CVKB, DBPA	05.15 ->	4	140	---	CSS308
A4 2.0 TFSI	CYMC, CYRB, DDWA	05.15 ->	4	185	---	CSS308
A4 2.0 TFSI	CADA, CDNA	06.08 - 05.13	4	155	---	CSS324
A4 2.0 TFSI	CAFA, CDNB, CDZA	06.08 - 12.15	4	132	---	CSS324
A4 2.0 TFSI flexible fuel	CFKA	11.09 - 12.15	4	132	CSS333	---
A4 2.0 TFSI flexible fuel	CFKA	11.09 - 12.15	4	132	---	CSS324
A4 2.0 TFSI flexible fuel quattro	CFKA	11.09 - 12.15	4	132	CSS333	---
A4 2.0 TFSI flexible fuel quattro	CFKA	11.09 - 12.15	4	132	---	CSS324
A4 2.0 TFSI quattro	BGB, BWE	11.04 - 06.08	4	147	---	CSS302
A4 2.0 TFSI quattro	BPG, BWT, BGB, BWE	11.04 - 06.08	4	147	CSS325	---
A4 2.0 TFSI quattro	BUL	06.05 - 06.08	4	162	CSS325	CSS302
A4 2.0 TFSI quattro	CDNC	06.08 - 12.15	4	155	---	CSS324
A4 2.0 TFSI quattro	CDNC, CPMA	06.08 - 12.15	4	155	CSS333	---
A4 2.0 TFSI quattro	CDNC, CPMA	06.08 - 12.15	4	155	CSS313	---
A4 2.0 TFSI quattro	CNCD	05.13 - 12.15	4	165	---	CSS308
A4 2.0 TFSI quattro	CNCD	05.13 - 12.15	4	165	---	CSS324
A4 2.0 TFSI quattro	CPMB, CAED	05.13 - 12.15	4	162	---	CSS324
A4 2.0 TFSI quattro	CYMC, CYRB, DDWA	05.15 ->	4	185	---	CSS308
A4 2.4	AGA, ALF, AML, APS, ARJ	03.97 - 11.00	6	121	CSS311	CSS318
A4 2.4	AJG, AMM, APZ	08.97 - 11.00	6	120	CSS311	CSS318
A4 2.4	AMM	09.01 - 12.04	6	120	---	CSS318
A4 2.4	BDV	09.01 - 12.04	6	125	---	CSS318
A4 2.4 quattro	AGA, ALF, AML, APS, ARJ	03.97 - 11.00	6	121	CSS311	CSS318
A4 2.6	ABC	01.95 - 11.00	6	110	CSS312	CSS317
A4 2.6 quattro	ABC	01.95 - 11.00	6	110	CSS312	CSS317
A4 2.7 S4 quattro	AGB, AZB	09.97 - 11.00	6	195	CSS311	---
A4 2.7 TDI	BPP	01.06 - 06.08	6	132	---	CSS332
A4 2.7 TDI	BPP	01.06 - 06.08	6	132	CSS314	---
A4 2.7 TDI	BSG	11.05 - 06.08	6	120	---	CSS332
A4 2.7 TDI	BSG	11.05 - 06.08	6	120	CSS314	---
A4 2.7 TDI	CAMA, CGKA	11.07 - 03.12	6	140	---	CSS324
A4 2.7 TDI	CAMB, CGKB	11.07 - 03.12	6	120	---	CSS324
A4 2.8	AAH	09.95 - 07.97	6	128	CSS312	---
A4 2.8	ABC	09.95 - 07.97	6	128	---	CSS317
A4 2.8	ACK, ALG, AMX, APR, AQD	10.96 - 11.00	6	142	CSS311	CSS318
A4 2.8 quattro	AAH	01.95 - 07.97	6	128	CSS312	CSS317
A4 2.8 quattro	ACK, ALG, AMX, APR, AQD	10.96 - 11.00	6	142	CSS311	CSS318
A4 3.0	ASN	11.00 - 12.04	6	162	CSS311	CSS302
A4 3.0	BBJ	04.01 - 12.04	6	160	---	CSS302
A4 3.0 quattro	ASN	11.00 - 12.04	6	162	CSS311	CSS302
A4 3.0 quattro	BBJ	04.01 - 12.04	6	160	---	CSS302
A4 3.0 S4 quattro	CAKA, CCBA	11.08 - 12.15	6	245	---	CSS324
A4 3.0 TDI quattro	ASB	01.06 - 06.08	6	171	---	CSS332
A4 3.0 TDI quattro	ASB	01.06 - 06.08	6	171	CSS314	---
A4 3.0 TDI quattro	BKN	11.04 - 06.08	6	150	---	CSS332
A4 3.0 TDI quattro	BKN	11.04 - 06.08	6	150	CSS314	---
A4 3.0 TDI quattro	CADA, CCWA, CCLA	11.07 - 03.12	6	176	---	CSS324
A4 3.0 TDI quattro	CCWB	06.08 - 05.10	6	155	---	CSS324
A4 3.0 TDI quattro	CRTC	05.15 ->	6	200	---	CSS308
A4 3.0 TDI quattro	CSWB	09.15 ->	6	160	---	CSS308
A4 3.0 TFSI quattro	CMUA	02.12 - 12.15	6	200	---	CSS324
A4 3.0 TFSI quattro	CMUA, CRED	02.12 - 12.15	6	200	---	CSS308
A4 3.2 FSI	AUK	01.05 - 06.08	6	188	---	CSS332
A4 3.2 FSI	AUK	01.05 - 06.08	6	188	---	CSS324
A4 3.2 FSI	CALA	09.08 - 03.12	6	195	---	CSS324
A4 3.2 FSI quattro	AUK	01.05 - 06.08	6	188	---	CSS332
A4 3.2 FSI quattro	AUK	01.05 - 06.08	6	188	---	CSS324
A4 3.2 FSI quattro	CALA	11.07 - 03.12	6	195	---	CSS324

Typ Type	Motornummer Engine-No.	Baujahr Year	Zyl. Cyl.	KW	Kurbelwellen- sensor Crankshaft S.	Nocken- wellensensor Camshaft S.
A4 4.2 RS4 quattro	BNS	09.05 - 06.08	8	309	---	CSS324
A4 4.2 S4 quattro	BBK	03.03 - 12.04	8	253	---	CSS302
A4 Allroad 2.0 TDI quattro	CAGA, CJCA	09.09 - 05.16	4	105	CSS313	---
A4 Allroad 2.0 TDI quattro	CAGB, CJCB, CSUB	09.09 - 05.16	4	100	CSS313	---
A4 Allroad 2.0 TDI quattro	CAHA	04.09 - 05.16	4	125	CSS313	---
A4 Allroad 2.0 TDI quattro	CAHB, CGLD, CNHC	04.09 - 05.16	4	120	CSS313	---
A4 Allroad 2.0 TDI quattro	CGLC	11.11 - 05.16	4	130	CSS313	CSS331
A4 Allroad 2.0 TDI quattro	CJCD	05.13 ->	4	110	CSS322	---
A4 Allroad 2.0 TDI quattro	CJCD, CSUA	05.13 - 05.16	4	110	CSS313	CSS331
A4 Allroad 2.0 TDI quattro	CNHA	09.13 - 05.16	4	140	CSS313	CSS331
A4 Allroad 2.0 TFSI quattro	CNCD	05.13 - 05.16	4	165	CSS313	---
A4 Allroad 2.0 TFSI quattro	CPMB	05.13 - 05.16	4	162	CSS313	---
A4 Allroad 2.0 TFSI quattro	CPMB	05.13 ->	4	162	---	CSS324
A4 Cabriolet 2.0 TFSI 16V	BWT, BWE	01.06 - 03.09	4	147	CSS325	CSS302
A4 Cabriolet 2.7 TDI	BPP	06.06 - 03.09	6	132	---	CSS332
A4 Cabriolet 3.0 TDI quattro	ASB	01.06 - 03.09	6	171	---	CSS332
A4 Cabriolet 3.0 TDI quattro	BKN	01.06 - 03.09	6	150	---	CSS332
A4 Cabriolet 3.2 FSI	AUK	01.06 - 03.09	6	188	---	CSS332
A4 Cabriolet 3.2 FSI quattro	AUK	01.06 - 03.09	6	188	---	CSS332
A4 Cabriolet S4 quattro	BBK	03.04 - 03.09	8	253	---	CSS332
A4 S4 quattro	BBK	03.03 - 12.04	8	253	---	CSS332
A4 S4 quattro	BBK	11.04 - 06.08	8	253	---	CSS332
A4 S4 quattro	CGWC, CGXC, CREC, CTUB	11.08 - 12.15	6	245	---	CSS308
A5 1.8 TFSI	CABD	10.07 ->	4	125	---	CSS324
A5 1.8 TFSI	CABD, CJEB	10.07 - 01.17	4	125	CSS313	CSS308
A5 1.8 TFSI	CDHB	05.09 - 09.11	4	118	CSS313	---
A5 1.8 TFSI	CJEE	05.15 - 01.17	4	130	---	CSS308
A5 1.8 TFSI	DHHB	05.09 ->	4	118	---	CSS324
A5 2.0 TDI	CAHA	08.08 - 03.12	4	125	CSS333	---
A5 2.0 TDI	CAHA	08.08 ->	4	125	CSS322	---
A5 2.0 TDI	CAHB	08.08 ->	4	120	CSS322	---
A5 2.0 TDI	CAHB, CGLD, CNHC	08.08 - 01.17	4	120	CSS333	---
A5 2.0 TDI	CGLC	10.11 - 01.17	4	130	---	CSS331
A5 2.0 TDI	CNHA	09.13 - 01.17	4	140	---	CSS331
A5 2.0 TDI   quattro	CAHA	08.08 - 03.12	4	125	CSS333	---
A5 2.0 TDI quattro	CAHB	08.08 ->	4	125	CSS322	---
A5 2.0 TDI quattro	CGLC	12.11 - 01.17	4	130	---	CSS331
A5 2.0 TDI quattro	CNHA	09.13 - 01.17	4	140	---	CSS331
A5 2.0 TFSI	CDNB	11.08 - 03.12	4	132	CSS333	---
A5 2.0 TFSI	CDNB	11.08 - 03.12	4	132	CSS313	CSS324
A5 2.0 TFSI	CDNC	06.08 - 11.13	4	155	CSS313	CSS324
A5 2.0 TFSI	CNCD	05.13 - 05.16	4	165	---	CSS308
A5 2.0 TFSI	CNCE	08.15 - 01.17	4	169	---	CSS308
A5 2.0 TFSI	CVKB	09.16 ->	4	140	---	CSS308
A5 2.0 TFSI	CYRB, DDWA	11.16 ->	4	185	---	CSS308
A5 2.0 TFSI   quattro	CAEB, CDNC	06.08 - 01.17	4	155	CSS333	---
A5 2.0 TFSI   quattro	CAEB, CDNC	06.08 - 01.17	4	155	CSS313	---
A5 2.0 TFSI   quattro	CNCE	08.15 - 01.17	4	169	---	CSS308
A5 2.0 TFSI quattro	CAEB, CDNC	06.08 ->	4	155	---	CSS324
A5 2.0 TFSI quattro	CNCD	05.13 - 05.16	4	165	---	CSS308
A5 2.0 TFSI quattro	CYMC, CYRB, DDWA	06.16 ->	4	185	---	CSS308
A5 2.0 TFSI quattro	CYRC	06.16 ->	4	183	---	CSS308
A5 2.7 TDI	CAMA, CGKA	06.07 ->	6	140	---	CSS324
A5 2.7 TDI	CAMB, CGKB	09.07 ->	6	120	---	CSS324
A5 3.0 S5 quattro	CAKA	10.11 ->	6	245	---	CSS324
A5 3.0 TDI quattro	CAPA, CCWA	06.07 ->	6	176	---	CSS324
A5 3.0 TDI quattro	CCWB	03.08 ->	6	155	---	CSS324
A5 3.0 TFSI   quattro	CHMB, CMUA, CRED	12.11 - 01.17	6	200	---	CSS308
A5 3.2 FSI	CALA	06.07 ->	6	195	---	CSS324

Typ Type	Motornummer Engine-No.	Baujahr Year	Zyl. Cyl.	KW	Kurbelwellen- sensor Crankshaft S.	Nocken- wellensensor Camshaft S.
A5 3.2 FSI quattro	CALA	06.07 ->	6	195	---	CSS324
A5 4.2 RS5 quattro	CFSA	03.10 ->	8	331	---	CSS324
A5 4.2 S5 quattro	CAUA	06.07 ->	8	260	---	CSS324
A5 Cabriolet 1.8 TFSI	CDHB	09.09 - 03.13	4	118	CSS313	---
A5 Cabriolet 2.0 TDI	CGLC	10.11 - 01.17	4	130	---	CSS331
A5 Cabriolet 2.0 TDI	CJCA	10.11 - 05.15	4	105	---	CSS331
A5 Cabriolet 2.0 TDI	CJCD	05.13 ->	4	110	CSS322	---
A5 Cabriolet 2.0 TDI	CJCD, CSUA	05.13 - 01.17	4	110	---	CSS331
A5 Cabriolet 2.0 TDI	CNHA	09.13 - 01.17	4	140	---	CSS331
A5 Cabriolet 2.0 TDI quattro	CGLC	01.12 - 05.15	4	130	---	CSS331
A5 Cabriolet 2.0 TDI quattro	CGLC	01.12 ->	4	130	CSS322	---
A5 Cabriolet 2.0 TDI quattro	CNHA	09.13 - 01.17	4	140	---	CSS331
A5 Cabriolet 2.0 TFSI	CAEA, CDNB	03.09 - 03.12	4	132	CSS313	---
A5 Cabriolet 2.0 TFSI	CAEB, CDNC	03.09 - 06.14	4	155	CSS313	---
A5 Cabriolet RS 5 quattro	CFSA	02.13 ->	8	331	---	CSS324
A5 S5 quattro	CGXC, CREC, CTDA, CTUB	10.11 - 01.17	6	245	---	CSS308
A5 Sportback 1.8 TFSI	CDHB	11.09 - 09.11	4	118	CSS313	CSS324
A5 Sportback 1.8 TFSI	CJEB	08.11 - 01.17	4	125	---	CSS308
A5 Sportback 1.8 TFSI	CJED	09.14 - 01.17	4	106	---	CSS308
A5 Sportback 1.8 TFSI	CJEE	05.15 - 01.17	4	130	---	CSS308
A5 Sportback 2.0 TDI	CAGA, CJCA, CMEA, CMFA	09.09 - 01.17	4	105	CSS333	---
A5 Sportback 2.0 TDI	CAGA, CMEA	09.09 ->	4	105	CSS322	---
A5 Sportback 2.0 TDI	CAGB	09.09 ->	4	100	CSS322	---
A5 Sportback 2.0 TDI	CAGB, CJCB, CSUB	09.09 - 01.17	4	100	CSS333	---
A5 Sportback 2.0 TDI	CAHA	09.09 - 03.12	4	125	CSS333	---
A5 Sportback 2.0 TDI	CAHA	09.09 ->	4	125	CSS322	---
A5 Sportback 2.0 TDI	CAHB	09.09 ->	4	120	CSS322	---
A5 Sportback 2.0 TDI	CAHB, CGLD, CNHC	09.09 - 01.17	4	120	CSS333	---
A5 Sportback 2.0 TDI	CJCD	05.13 ->	4	110	CSS322	---
A5 Sportback 2.0 TDI	CJCD, CMFB, CSUA	05.13 - 01.17	4	110	---	CSS331
A5 Sportback 2.0 TDI quattro	CAHA	09.09 - 03.13	4	125	CSS333	---
A5 Sportback 2.0 TDI quattro	CAHA	09.09 ->	4	125	CSS322	---
A5 Sportback 2.0 TDI quattro	CNHA	09.13 - 01.17	4	140	---	CSS331
A5 Sportback 2.0 TFSI	CDNB	09.09 - 06.14	4	132	CSS333	---
A5 Sportback 2.0 TFSI	CDNB	09.09 - 06.14	4	132	CSS313	---
A5 Sportback 2.0 TFSI	CDNB	09.09 ->	4	132	---	---
A5 Sportback 2.0 TFSI	CDNC	09.09 - 11.13	4	155	CSS313	CSS324
A5 Sportback 2.0 TFSI	CNCD	05.13 - 05.16	4	165	---	CSS308
A5 Sportback 2.0 TFSI	CNCE	08.15 - 01.17	4	169	---	CSS308
A5 Sportback 2.0 TFSI   quattro	CAEB, CDNC	09.09 - 01.17	4	155	CSS313	---
A5 Sportback 2.0 TFSI   quattro	CNCE	08.15 - 01.17	4	169	---	CSS308
A5 Sportback 2.0 TFSI quattro	CDNC	09.09 ->	4	155	---	CSS324
A5 Sportback 2.0 TFSI quattro	CNCD	05.13 - 05.16	4	165	---	CSS308
A5 Sportback 2.7 TDI	CGKA	09.09 ->	6	120	---	CSS324
A5 Sportback 2.7 TDI	CGKB	09.09 ->	6	140	---	CSS324
A5 Sportback 3.0 S5 quattro	CAKA	01.10 ->	6	245	---	CSS324
A5 Sportback 3.0 TDI quattro	CCWA	09.09 ->	6	176	---	CSS324
A5 Sportback 3.0 TFSI quattro	CHMB, CMUA, CRED	12.11 - 01.17	6	200	---	CSS308
A5 Sportback 3.2 FSI quattro	CALA	09.09 ->	6	195	---	CSS324
A5 Sportback S5 quattro	CAKA, CGWC, CGXC, CREC	01.10 - 01.17	6	245	---	CSS308
A6 1.4	BDW	05.04 - 10.08	6	130	---	CSS332
A6 1.8	ADR	12.95 - 10.97	4	92	---	CSS318
A6 1.8	AFY	05.97 - 01.05	4	85	CSS325	---
A6 1.8	AJP, AQE, ARH	07.97 - 01.05	4	92	---	CSS318
A6 1.8	AJP, AQE, ARH	07.97 - 01.05	4	92	CSS311	---
A6 1.8 quattro	ADR	12.95 - 10.97	4	92	---	CSS318
A6 1.8 T	AEB, ANB, APU, ARK, AWL, AWT	01.97 - 01.05	4	110	---	CSS318
A6 1.8 T	AJL	12.97 - 01.05	4	132	---	CSS318
A6 1.8 T quattro	AEB, ANB, APU, ARK, AWT	02.97 - 01.05	4	110	---	CSS318

Typ Type	Motornummer Engine-No.	Baujahr Year	Zyl. Cyl.	KW	Kurbelwellen- sensor Crankshaft S.	Nocken- wellensensor Camshaft S.
A6 1.8 T quattro	AJL	12.97 - 01.05	4	132	---	CSS318
A6 1.8 TFSI	CYGA	09.14 ->	4	140	---	CSS308
A6 2.0	ALT	08.01 - 01.05	4	96	---	CSS318
A6 2.0 TDI	BLB, BRE	07.04 - 10.08	4	103	---	CSS330
A6 2.0 TDI	BNA, BRF, CAGB	07.04 - 03.11	4	100	CSS322	---
A6 2.0 TDI	BVG	09.05 - 06.06	4	89	---	CSS330
A6 2.0 TDI	CAGB, BNA, BRF	07.04 - 03.11	4	100	---	CSS330
A6 2.0 TDI	CAHA	11.08 - 03.11	4	125	CSS322	---
A6 2.0 TDI	CGLC, CMGB	03.11 ->	4	130	CSS322	CSS331
A6 2.0 TDI	CGLD	03.11 ->	4	120	CSS322	CSS331
A6 2.0 TDI	CGLE	01.12 ->	4	100	CSS322	---
A6 2.0 TDI	CSUD, DDCB	09.14 ->	4	110	---	CSS331
A6 2.0 TDI	CSUE, CGLE	01.12 ->	4	100	---	CSS331
A6 2.0 TDI	CZJA, CNHA, DDDA	11.13 ->	4	140	---	CSS331
A6 2.0 TDI quattro	CNHA, DDDA	04.15 ->	4	140	---	CSS331
A6 2.0 TFSI	BPJ, BYK	06.05 - 03.11	4	125	CSS325	CSS302
A6 2.0 TFSI	CAEB	03.11 - 05.13	6	155	---	CSS324
A6 2.0 TFSI	CAED	05.13 ->	4	162	---	CSS324
A6 2.0 TFSI	CDNB	05.11 ->	6	132	---	CSS324
A6 2.0 TFSI	CYNB, CYPA	09.14 ->	4	185	---	CSS308
A6 2.0 TFSI hybrid	CHJA	11.11 ->	6	155	---	CSS324
A6 2.0 TFSI quattro	CAEB	05.12 - 05.13	4	155	---	CSS324
A6 2.0 TFSI quattro	CAED	05.13 ->	4	162	---	CSS324
A6 2.0 TFSI quattro	CYNB, CYPA	05.14 ->	4	185	---	CSS308
A6 2.0 TFSI quattro	CYPB	05.15 ->	4	183	---	CSS308
A6 2.2 S6 Turbo quattro	AAN	06.94 - 10.97	5	169	CSS312	---
A6 2.4	AGA, ALF, AML, APS, ARJ	02.97 - 01.05	6	121	CSS311	CSS318
A6 2.4	ALW, ARN, ASM	07.98 - 01.05	6	100	CSS311	CSS318
A6 2.4	APC	02.97 - 01.05	6	115	---	CSS318
A6 2.4	BDV	08.01 - 01.05	6	125	CSS311	CSS318
A6 2.4	BDW	05.04 - 10.08	6	130	---	CSS324
A6 2.4 quattro	AGA, ALF, AML, APS, ARJ	02.97 - 01.05	6	121	CSS311	CSS318
A6 2.4 quattro	AJG, APZ	02.97 - 01.05	6	120	CSS311	CSS318
A6 2.4 quattro	APC	08.98 - 07.99	6	115	CSS311	CSS318
A6 2.4 quattro	BDV	08.01 - 01.05	6	125	---	CSS318
A6 2.4 quattro	BDW	01.05 - 10.08	6	130	---	CSS332
A6 2.5 TDI	AAT	01.95 - 10.97	5	84	CSS312	---
A6 2.5 TDI	AAT	06.94 - 10.97	5	85	CSS312	---
A6 2.5 TDI	AEL	08.94 - 10.97	5	103	CSS312	---
A6 2.5 TDI quattro	AEL	10.95 - 10.97	5	103	CSS312	---
A6 2.6	ABC	06.94 - 12.97	6	110	CSS312	CSS317
A6 2.6	ABC	06.94 - 10.97	6	110	CSS312	CSS317
A6 2.6 quattro	ABC	06.94 - 10.97	6	110	---	CSS317
A6 2.7 T	AJK	02.99 - 01.05	6	169	CSS311	CSS318
A6 2.7 T quattro	AJK	12.97 - 01.05	6	169	CSS311	CSS318
A6 2.7 T quattro	ARE, BES	08.01 - 01.05	6	184	CSS311	CSS318
A6 2.7 TDI	BPP	11.04 - 10.08	6	132	CSS314	CSS332
A6 2.7 TDI	BSG, CANB	11.04 - 03.11	6	120	CSS314	CSS332
A6 2.7 TDI	BSG, CAND	10.08 - 03.11	6	140	---	CSS324
A6 2.7 TDI	BSG, CAND	10.08 - 03.11	6	140	---	CSS324
A6 2.7 TDI	CANA	11.04 - 03.11	6	120	---	CSS324
A6 2.7 TDI quattro	BPP	11.04 - 10.08	6	132	CSS314	CSS332
A6 2.7 TDI quattro	BSG, CAND	06.05 - 03.11	6	120	CSS314	CSS332
A6 2.7 TDI quattro	CANC	06.05 - 03.11	6	120	---	CSS324
A6 2.8	AAH	06.94 - 10.97	6	128	CSS312	CSS317
A6 2.8	ACK	12.95 - 10.97	6	142	---	CSS318
A6 2.8	ACK, ALG, AMX, APR, AQD	02.97 - 01.05	6	142	CSS311	CSS318
A6 2.8	ATX	07.99 - 01.05	6	140	---	CSS318
A6 2.8	AGE	10.97 - 07.98	6	132	---	CSS318

Typ Type	Motornummer Engine-No.	Baujahr Year	Zyl. Cyl.	KW	Kurbelwellen- sensor Crankshaft S.	Nocken- wellensensor Camshaft S.
A6 2.8 FSI	BDX	10.08 - 03.11	6	162	---	CSS324
A6 2.8 FSI	CCDA	10.08 - 03.11	6	140	---	CSS324
A6 2.8 FSI	CCEA	11.06 - 10.08	6	154	---	CSS324
A6 2.8 FSI	CHVA	03.11 - 04.15	6	150	---	CSS324
A6 2.8 FSI quattro	BDX	06.07 - 10.08	6	154	---	CSS324
A6 2.8 FSI quattro	CCDA	10.08 - 03.11	6	140	---	CSS324
A6 2.8 FSI quattro	CCEA	10.08 - 03.11	6	162	---	CSS324
A6 2.8 FSI quattro	CHVA	03.11 - 04.15	6	150	---	CSS324
A6 2.8 quattro	AAH	06.94 - 10.97	6	128	CSS312	CSS317
A6 2.8 quattro	ACK	12.95 - 10.97	6	142	---	CSS318
A6 2.8 quattro	ACK, ALG, AMX, APR, AQD	02.97 - 01.05	6	142	CSS311	CSS318
A6 3.0	ASN	08.01 - 01.05	6	162	---	CSS302
A6 3.0	ASN	08.01 - 01.05	6	162	CSS311	---
A6 3.0 quattro	ASN	08.01 - 01.05	6	162	CSS311	CSS302
A6 3.0 TDI	CLAB	03.11 ->	6	150	---	CSS324
A6 3.0 TDI	CTCB, CZVD	09.14 ->	6	155	---	CSS308
A6 3.0 TDI quattro	ASB	06.06 - 10.08	6	171	CSS314	CSS332
A6 3.0 TDI quattro	BMK	05.04 - 05.06	6	165	CSS314	CSS332
A6 3.0 TDI quattro	BNG, CDYB	05.04 - 03.11	6	155	CSS314	CSS332
A6 3.0 TDI quattro	BNG, CDYB	05.04 - 03.11	6	155	---	CSS324
A6 3.0 TDI quattro	CDUC, CDUD, CKVB, CKVC	03.11 ->	6	180	---	CSS324
A6 3.0 TDI quattro	CDYA, CDYB	10.08 - 03.11	6	176	---	CSS324
A6 3.0 TDI quattro	CDYA, CDYC	10.08 - 03.11	6	176	---	CSS332
A6 3.0 TDI quattro	CGQB	11.11 ->	6	230	---	CSS324
A6 3.0 TDI quattro	CLAA	03.11 ->	6	150	---	CSS324
A6 3.0 TDI quattro	CPNB	05.13 ->	6	176	---	CSS324
A6 3.0 TDI quattro	CRTD	09.14 ->	6	200	---	CSS308
A6 3.0 TDI quattro	CRTE, CZVA	09.14 ->	6	160	---	CSS308
A6 3.0 TDI quattro	CRTF, CZVC	09.14 ->	6	155	---	CSS308
A6 3.0 TFSI quattro	CAJA	10.08 - 03.11	6	213	---	CSS324
A6 3.0 TFSI quattro	CCAA	10.08 - 03.11	6	220	---	CSS324
A6 3.0 TFSI quattro	CGWB	11.10 - 05.12	6	220	---	CSS324
A6 3.0 TFSI quattro	CGWD, CGXB, CTUA	03.11 ->	6	228	---	CSS324
A6 3.0 TFSI quattro	CREC	09.14 ->	6	245	---	CSS308
A6 3.2 FSI	AUK, BKH	05.04 - 05.09	6	188	---	CSS332
A6 3.2 FSI	AUK, BKH	05.04 - 10.08	6	188	---	CSS324
A6 3.2 FSI quattro	AUK	05.04 - 10.08	6	188	---	CSS332
A6 4.2   quattro	BAT	05.04 - 05.06	8	246	---	CSS332
A6 4.2 FSI quattro	BVJ	06.06 - 03.11	8	257	---	CSS324
A6 4.2 quattro	ARS, ASG	11.98 - 01.05	8	220	---	CSS318
A6 4.2 quattro	BAT	05.04 - 05.06	8	246	---	CSS302
A6 4.2 S6 quattro	AEC	06.94 - 10.97	8	213	CSS312	---
A6 4.2 S6 quattro	ANK, AQJ	09.99 - 01.05	8	250	---	CSS318
A6 5.0 RS6 quattro	BUH	09.08 - 03.11	10	426	---	CSS324
A6 5.2 S6 quattro	BXA	03.06 - 03.11	10	320	---	CSS324
A6 Allroad 2.7 TDI quattro	BPP	05.06 - 10.08	6	132	---	CSS332
A6 Allroad 2.7 TDI quattro	BSG, CAND	05.06 - 08.11	6	120	---	CSS332
A6 Allroad 3.0 TDI quattro	ASB	05.06 - 10.08	6	171	---	CSS332
A6 Allroad 3.0 TDI quattro	BNG, CDYB	05.06 - 08.11	6	155	---	CSS332
A6 S6 quattro	CTGE	10.14 ->	8	331	---	CSS308
A7 Sportback 2.0 TFSI	CYPA	09.14 ->	4	185	---	CSS308
A7 Sportback 2.0 TFSI quattro	CYNB, CYPA	05.15 ->	4	185	---	CSS308
A7 Sportback 2.0 TFSI quattro	CYPB	05.15 ->	4	183	---	CSS308
A7 Sportback 2.8 FSI	CHVA	02.11 ->	6	150	---	CSS324
A7 Sportback 2.8 FSI quattro	CHVA, CNYA	10.10 ->	6	150	---	CSS324
A7 Sportback 3.0 TDI	CLAB	11.10 ->	6	150	---	CSS324
A7 Sportback 3.0 TDI quattro	CDUC, CDUD, CKVB, CKVC	10.10 ->	6	180	---	CSS324
A7 Sportback 3.0 TDI quattro	CGWB	10.10 ->	6	220	---	CSS324
A7 Sportback 3.0 TDI quattro	CPNB	05.13 ->	6	176	---	CSS324

Typ Type	Motornummer Engine-No.	Baujahr Year	Zyl. Cyl.	KW	Kurbelwellen- sensor Crankshaft S.	Nocken- wellensensor Camshaft S.
A7 Sportback 3.0 TDI quattro	CRTD	05.14 ->	6	200	---	CSS308
A7 Sportback 3.0 TDI quattro	CRTE, CZVA	07.14 ->	6	160	---	CSS308
A7 Sportback 3.0 TDI quattro	CRTF, CTCB, CZVC	07.14 ->	6	155	---	CSS308
A7 Sportback S7 quattro	CTGE	07.14 ->	8	331	---	CSS308
A8 2.0 TFSI hybrid	CHJA	02.12 ->	4	155	---	CSS324
A8 2.0 TFSI quattro	CYPA	09.16 ->	4	185	---	CSS308
A8 2.5 TFSI	CPAA	07.12 ->	6	150	---	CSS324
A8 2.8	AAH	03.94 - 03.96	6	128	CSS312	CSS317
A8 2.8	ACK, ALG, AMX, APR, AQD	04.96 - 09.02	6	142	CSS311	CSS318
A8 2.8	AEJ	07.95 - 03.96	6	120	---	CSS317
A8 2.8 FSI	BDX	08.07 - 07.10	6	154	---	CSS324
A8 2.8 quattro	AAH	03.94 - 03.96	6	128	CSS312	CSS317
A8 2.8 quattro	ACK, AMX, APR, AQD	04.96 - 09.02	6	142	CSS311	CSS318
A8 2.8 quattro	AEJ	07.95 - 03.96	6	120	---	CSS317
A8 3.0	ASN	08.03 - 07.10	6	162	---	CSS302
A8 3.0	BBJ	07.03 - 07.10	6	160	---	CSS302
A8 3.0 TDI quattro	ASB	08.03 - 07.10	6	171	CSS314	CSS332
A8 3.0 TDI quattro	BNG	11.03 - 07.10	6	155	CSS314	CSS332
A8 3.0 TDI quattro	CPNA	11.12 ->	6	176	---	CSS324
A8 3.0 TDI quattro	CTBA	10.13 ->	6	190	---	CSS324
A8 3.0 TFSI quattro	CGWA, CGXA, CREG	07.10 ->	6	213	---	CSS308
A8 3.0 TFSI quattro	CGWD, CREA	11.11 ->	6	228	---	CSS308
A8 3.0 TFSI quattro	CGXC, CMDA, CREC, CTDA	06.10 ->	6	245	---	CSS308
A8 3.2 FSI	BPK	06.05 - 07.10	6	191	---	CSS324
A8 3.2 FSI quattro	BPK	06.05 - 07.10	6	191	---	CSS324
A8 3.7	ACK, AQD	11.98 - 09.02	8	191	---	CSS318
A8 3.7	AEW	07.95 - 12.98	8	169	---	CSS318
A8 3.7 quattro	AEW, AKJ	07.95 - 11.98	8	169	---	CSS318
A8 3.7 quattro	AKC, AQG	11.98 - 09.02	8	191	---	CSS318
A8 3.7 quattro	BFL	10.02 - 07.10	8	206	---	CSS318
A8 4.0 TDI quattro	ASE	05.03 - 07.05	8	202	---	CSS332
A8 4.0 TFSI quattro	CEUA	03.12 ->	8	309	---	CSS308
A8 4.0 TFSI quattro	CTGA	10.13 ->	8	320	---	CSS308
A8 4.2 FSI quattro	BVJ	06.06 - 07.10	6	257	---	CSS324
A8 4.2 FSI quattro	CDRA	11.09 ->	8	273	---	CSS324
A8 4.2 quattro	ABZ, AKG	03.94 - 11.98	8	220	---	CSS318
A8 4.2 quattro	AEM	03.94 - 07.96	8	180	---	CSS318
A8 4.2 quattro	AGF, AUW, AUK	11.98 - 09.02	8	228	---	CSS318
A8 4.2 quattro	ARU	02.99 - 04.00	8	175	---	CSS318
A8 4.2 quattro	BFM	10.02 - 07.10	8	246	---	CSS318
A8 4.2 S8 quattro	AHC, AKH	07.96 - 06.99	8	250	---	CSS318
A8 4.2 S8 quattro	AQH, AVP	06.99 - 09.02	8	265	---	CSS318
A8 4.2 TDI quattro	BVN	07.05 - 07.10	8	240	---	CSS332
A8 4.2 TDI quattro	CDSB	11.09 ->	8	258	---	CSS324
A8 4.2 TDI quattro	CTEC	10.13 ->	8	283	---	CSS324
A8 5.2 S8 quattro	BSM	06.06 - 07.10	10	331	---	CSS324
A8 6.0 W12 quattro	AZC	01.01 - 09.02	12	309	---	CSS323
A8 6.0 W12 quattro	BHT	12.03 - 07.10	12	331	---	CSS323
A8 S8 plus quattro	DDTA	11.15 ->	8	445	---	CSS308
A8 S8 quattro	CGTA, CTFA	04.12 ->	8	382	---	CSS308
Allroad 4.2 V8 quattro	BAS	07.02 - 08.05	8	220	---	CSS332
Q3 1.4 TFSI	CHPB, CZDA, CZEA	10.13 ->	4	110	---	CSS308
Q3 1.4 TFSI	CZDB	07.16 ->	4	92	---	CSS308
Q3 2.0 TDI	CFGC	05.13 ->	4	130	CSS322	---
Q3 2.0 TDI	CUVD, DFTC	03.15 ->	4	88	---	CSS331
Q3 2.0 TDI	CUWA	05.15 ->	4	135	---	CSS331
Q3 2.0 TDI	DBBA, CUVC, DFTA	11.14 ->	4	110	---	CSS331
Q3 2.0 TDI quattro	CFFB	01.12 ->	4	103	CSS322	---
Q3 2.0 TDI quattro	CUVC, DFTA	11.14 ->	4	110	---	CSS331

Typ Type	Motornummer Engine-No.	Baujahr Year	Zyl. Cyl.	KW	Kurbelwellen- sensor Crankshaft S.	Nocken- wellensensor Camshaft S.
Q3 2.0 TDI quattro	CYLA, DFUA, CUWA	11.14 ->	4	135	---	CSS331
Q5 2.0 TDI	CAGA, CJCA	08.09 ->	4	105	CSS322	---
Q5 2.0 TDI	CAGB	08.09 ->	4	100	CSS322	---
Q5 2.0 TDI	CAHA, CGLB, CMGA	11.08 ->	4	125	CSS322	---
Q5 2.0 TDI	CAHB, CGLA	11.08 ->	4	120	CSS322	---
Q5 2.0 TDI	CJCA	11.10 ->	4	105	CSS333	---
Q5 2.0 TDI	CJCB, CSUB	11.10 ->	4	100	---	CSS331
Q5 2.0 TDI	CJCB, CSUB	11.10 ->	4	100	CSS333	---
Q5 2.0 TDI	CJCD	05.13 ->	4	110	CSS322	---
Q5 2.0 TDI	CJCD, CSUA	05.13 ->	4	110	---	CSS331
Q5 2.0 TDI quattro	CAGA, CJCA	08.09 ->	4	105	CSS333	---
Q5 2.0 TDI quattro	CAGB, CJCB, CSUB	08.09 ->	4	100	CSS333	---
Q5 2.0 TDI quattro	CGLC, CMGB	06.12 ->	4	130	---	CSS331
Q5 2.0 TDI quattro	CGLC, CMGB	06.12 ->	4	130	CSS322	---
Q5 2.0 TDI quattro	CJCD	05.13 ->	4	110	CSS322	---
Q5 2.0 TDI quattro	CJCD, CSUA	05.13 ->	4	110	---	CSS331
Q5 2.0 TDI quattro	CNHA	11.13 ->	4	140	CSS322	CSS331
Q5 2.0 TFSI	CDNB	08.09 ->	4	132	---	CSS324
Q5 2.0 TFSI	CDNC	11.08 ->	4	155	---	CSS324
Q5 2.0 TFSI hybrid	CHJA	06.11 ->	4	155	---	CSS324
Q5 2.0 TFSI quattro	CAEB, CDNC, CPMA	11.08 ->	4	155	CSS313	---
Q5 2.0 TFSI quattro	CDNB, CNCB	08.09 ->	4	132	CSS313	CSS308
Q5 2.0 TFSI quattro	CNCD	06.12 ->	4	165	---	CSS308
Q5 2.0 TFSI quattro	CNCD	06.12 ->	4	165	---	CSS324
Q5 2.0 TFSI quattro	CNCE	08.15 ->	4	169	---	CSS308
Q5 2.0 TFSI quattro	CPMB	05.13 ->	4	162	---	CSS324
Q5 2.0 TFSI quattro	DAXB, DAYB	06.16 ->	4	185	---	CSS308
Q5 2.0 TFSI quattro	DAXC	01.17 ->	4	183	---	CSS308
Q5 3.0 TDI	CCWA	11.08 ->	6	176	---	CSS324
Q5 3.0 TDI	CCWB	11.08 ->	6	155	---	CSS324
Q5 3.0 TDI quattro	CDUD	06.12 ->	6	180	---	CSS324
Q5 3.0 TDI quattro	CTBA	11.13 ->	6	190	---	CSS324
Q5 3.0 TFSI quattro	CTVA, CTUC	06.12 ->	6	200	---	CSS324
Q5 3.2 FSI	CALB	11.08 ->	6	199	---	CSS324
Q5 SQ5 TDI quattro	CGQB	12.12 ->	6	230	CSS322	CSS324
Q5 SQ5 TFSI quattro	CTUD, CTXA	05.13 ->	6	260	---	CSS324
Q7 2.0 TFSI quattro	CYRB	08.15 ->	4	185	---	CSS308
Q7 3.0 TDI	BUN, CASB	03.06 - 05.10	6	155	---	CSS324
Q7 3.0 TDI	CASA, CCMA, CJGA	11.07 - 09.15	6	176	---	CSS324
Q7 3.0 TDI	CATA	06.09 - 05.10	6	165	---	CSS324
Q7 3.0 TDI	CJGC, CJMA	05.10 - 08.15	6	150	---	CSS324
Q7 3.0 TDI quattro	BUG	03.06 - 05.08	6	171	---	CSS332
Q7 3.0 TDI quattro	BUN, CASB	03.06 - 05.10	6	155	---	CSS332
Q7 3.0 TFSI	CJTC, CJWC	05.10 - 08.15	6	200	---	CSS324
Q7 3.0 TFSI	CTJB, CJWB, CNAA	05.10 - 08.15	6	245	---	CSS324
Q7 3.0 TFSI quattro	CREC	01.15 ->	6	245	---	CSS308
Q7 4.2 FSI	BAR	03.06 - 05.10	8	257	---	CSS324
Q7 4.2 TDI	CCFA, CCFA	05.09 - 08.15	8	250	---	CSS324
Q7 4.2 TDI quattro	BTR	03.07 - 06.09	8	240	---	CSS332
Q7 6.0 TDI	CCGA	09.08 - 05.14	12	368	---	CSS324
R8 4.2 FSI quattro	BYH	04.07 - 09.10	8	309	---	CSS324
R8 4.2 FSI quattro	CNDA	07.10 - 07.15	8	316	---	CSS324
R8 5.2 FSI quattro	BUJ	04.09 - 07.15	10	386	---	CSS324
R8 5.2 FSI quattro	CMPA	11.10 - 07.15	10	412	---	CSS324
R8 5.2 FSI quattro	CTPA	05.12 - 07.15	10	404	---	CSS324
R8 Spyder 4.2 FSI quattro	CNDA	09.10 - 07.15	8	316	---	CSS324
R8 Spyder 5.2 FSI quattro	BUJ	02.10 - 07.15	10	386	---	CSS324
R8 Spyder 5.2 FSI quattro	CTPA	05.12 - 07.15	10	404	---	CSS324
TT 1.8 T	AJQ, APP, ARY, AUQ	10.98 - 06.06	4	132	---	CSS318

Typ Type	Motornummer Engine-No.	Baujahr Year	Zyl. Cyl.	KW	Kurbelwellen- sensor Crankshaft S.	Nocken- wellensensor Camshaft S.
TT 1.8 T	AJQ, APP, ARY, AUQ	10.98 - 06.06	4	132	CSS311	---
TT 1.8 T	AJQ, APP, AUQ, ATC	10.98 - 06.06	4	132	CSS325	---
TT 1.8 T	AUM	09.02 - 06.06	4	110	CSS325	CSS318
TT 1.8 T	BVP	09.05 - 06.06	4	120	CSS325	---
TT 1.8 T	BVR	09.05 - 06.06	4	140	CSS325	CSS318
TT 1.8 T quattro	AJQ, ARY, AUQ	10.98 - 06.06	4	132	CSS325	---
TT 1.8 T quattro	BAM, APX	10.98 - 06.06	4	165	CSS325	---
TT 1.8 T quattro	BVR	09.05 - 06.06	4	140	CSS325	---
TT 1.8 T quattro	AJQ, ARY	10.98 - 06.06	4	132	CSS311	CSS318
TT 1.8 T quattro	APX, BAM	10.98 - 06.06	4	165	CSS311	CSS318
TT 1.8 T quattro	BFV	03.05 - 06.06	4	176	---	CSS318
TT 1.8 T quattro	BVR	09.05 - 06.06	4	140	---	CSS318
TT 1.8 TFSI	CDAA	06.08 - 06.14	4	118	CSS313	CSS324
TT 1.8 TFSI	CJSA, CJSB	08.15 ->	4	132	---	CSS308
TT 2.0 quattro	CDMA, CDLA	05.08 - 06.14	4	195	CSS325	CSS302
TT 2.0 TDI	CUNA	07.14 ->	4	135	---	CSS331
TT 2.0 TDI quattro	CBBB, CFGB	06.08 ->	4	125	CSS322	---
TT 2.0 TFSI	BWA, BPY, CCTA	08.06 - 06.10	4	147	CSS325	CSS302
TT 2.0 TFSI	BWA, CCZA	08.06 - 06.10	4	147	---	CSS324
TT 2.0 TFSI	CESA	05.10 - 06.14	4	155	---	CSS324
TT 2.0 TFSI	CHHC	07.14 ->	4	169	---	CSS308
TT 2.0 TFSI quattro	BWA, CCZA	06.08 - 06.10	4	147	CSS313	---
TT 2.0 TFSI quattro	CCZA	06.08 - 06.10	4	147	---	CSS324
TT 2.0 TFSI quattro	CDLB	05.08 ->	4	200	CSS325	---
TT 2.0 TFSI quattro	CESA, CETA	05.10 - 06.14	4	155	---	CSS324
TT 2.0 TFSI quattro	CHHC	07.14 ->	4	169	---	CSS308
TT 2.0 TTS quattro	CJXF	02.15 ->	4	210	---	CSS308
TT 2.0 TTS quattro	CJXG	11.14 ->	4	228	---	CSS308
TT 2.5 TFSI RS quattro	CEPA	07.09 - 06.14	5	250	---	CSS324
TT 3.2 VR6 quattro	BHE, BPF	07.03 - 06.06	6	184	---	CSS323
TT Roadster 1.8 T	AJQ, APP, AUQ	10.99 - 06.06	4	132	CSS311	CSS318
TT Roadster 1.8 T	AUM	01.01 - 06.06	4	110	CSS325	CSS318
TT Roadster 1.8 T	BVP	09.05 - 06.06	4	120	CSS325	---
TT Roadster 1.8 T	BVP	09.05 - 06.06	4	120	---	CSS318
TT Roadster 1.8 T	BVR	09.05 - 06.06	4	140	CSS325	---
TT Roadster 1.8 T quattro	AJQ, ARY	02.00 - 06.06	4	132	CSS311	CSS318
TT Roadster 1.8 T quattro	APX, BAM	10.99 - 06.06	4	165	CSS311	CSS318
TT Roadster 1.8 T quattro	BVR	09.05 - 06.06	4	140	CSS325	---
TT Roadster 1.8 TFSI	CDAA	06.08 - 06.14	4	118	CSS313	---
TT Roadster 1.8 TFSI	CJSA, CJSB	08.15 ->	4	132	---	CSS308
TT Roadster 2.0 quattro	CDMA, CDLA	05.08 - 06.14	4	195	CSS325	CSS302
TT Roadster 2.0 TDI	CUNA	11.14 ->	4	135	---	CSS331
TT Roadster 2.0 TFSI	BWA	03.07 - 06.10	4	147	CSS313	---
TT Roadster 2.0 TFSI	BWA, BPY, CCTA	03.07 - 06.10	4	147	CSS325	CSS302
TT Roadster 2.0 TFSI	CHHC	11.14 ->	4	169	---	CSS308
TT Roadster 2.0 TFSI quattro	CCZA	06.08 - 06.10	4	147	CSS313	---
TT Roadster 2.0 TFSI quattro	CDLB	05.08 - 06.14	4	200	CSS325	CSS302
TT Roadster 2.5 TFSI RS quattro	CEPB	03.12 - 06.14	5	265	---	CSS324
<b>BMW</b>						
114 d (F20)	B37 D15 A	06.15 ->	3	70	---	CSS922
114 d (F21)	B37 D15 A	06.15 ->	3	70	---	CSS922
114 i (F20)	N13 B16 A	11.11 ->	4	75	CSS912	CSS920
114 i (F21)	N13 B16 A	12.11 ->	4	75	CSS912	CSS920
116 d (F20)	B37 D15 A	03.15 ->	3	85	---	CSS922
116 i (E81)	N43 B20 A	11.08 - 09.12	4	90	CSS917	---
116 i (E81)	N45 B16 A	04.07 - 12.11	4	85	CSS924	---
116 i (E81)	N45 B16 A, N43 B16 A	03.07 - 09.12	4	90	CSS917	---
116 i (E81, E87)	N45 B16 A	09.04 - 09.12	4	85	---	CSS902

Typ Type	Motornummer Engine-No.	Baujahr Year	Zyl. Cyl.	KW	Kurbelwellen- sensor Crankshaft S.	Nocken- wellensensor Camshaft S.
116 i (E87)	N45 B16 A	11.03 - 06.11	4	85	CSS924	---
116 i (F20)	B38 B15 A	03.15 ->	3	80	---	CSS922
116 i (F20)	N13 B16 A	12.10 ->	4	100	CSS912	CSS920
116 i (F21)	B38 B15 A	03.15 ->	3	80	---	CSS922
116 i (F21)	N13 B16 A	12.11 ->	4	100	CSS912	CSS920
118 d (E81, E87)	M47 D20 (204D4), N47 D20 A	09.06 - 09.12	4	90	---	CSS902
118 d (E87)	N47 D20 A, M47 D20 (204D4)	11.03 - 09.12	4	90	CSS919	CSS918
118 d (F20)	B47 D20 A	03.15 ->	4	110	---	CSS922
118 d (F21)	B47 D20 A	03.15 ->	4	110	---	CSS922
118 d xDrive (F20)	B47 D20 A	03.15 ->	4	110	---	CSS922
118 d xDrive (F21)	B47 D20 A	03.15 ->	4	110	---	CSS922
118 i (E81, E87)	N43 B20 A, N46 B20 B	09.06 - 09.12	4	95	---	CSS902
118 i (E81, E87)	N43 B20 A, N64 B20 B	09.06 - 09.12	4	105	CSS917	CSS902
118 i (E87)	N46 B20 B	07.04 - 02.07	4	95	CSS924	---
118 i (E87)	N46 B20 B	10.06 - 06.11	4	100	CSS924	---
118 i (F20)	B38 B15 A	03.15 ->	3	100	---	CSS922
118 i (F20)	N13 B16 A	11.10 ->	4	125	CSS912	CSS920
118 i (F20)	N13 B16 A	03.15 ->	4	100	---	CSS920
118 i (F21)	B38 B15 A	03.15 ->	3	100	---	CSS922
118 i (F21)	N13 B16 A	07.12 ->	4	125	CSS912	CSS920
118 i (F21)	N13 B16 A	03.15 ->	4	100	---	CSS920
118 i Cabriolet (E88)	N43 B20 A	03.08 - 12.13	4	105	CSS917	---
120 d (E81)	N47 D20 A, M47 D20 (204D4)	09.06 - 09.12	4	120	---	CSS918
120 d (E87)	N47 D20 A, M47 D20 (204D4), N47 D20C	11.03 - 09.12	4	120	CSS919	CSS918
120 d (E87)	N47 D20 A, M47 D20 (204D4)	11.03 - 09.12	4	130	CSS919	---
120 d (F20)	B47 D20 A	03.15 ->	4	140	---	CSS922
120 d (F21)	B47 D20 A	03.15 ->	4	140	---	CSS922
120 d xDrive (F20)	B47 D20 A	03.15 ->	4	140	---	CSS922
120 d xDrive (F21)	B47 D20 A	03.15 ->	4	140	---	CSS922
120 i (E81)	N46 B20 B, N43 B20 A	09.06 - 09.12	4	120	CSS917	CSS902
120 i (E81)	N46 B20 B, N43 B20 A	09.06 - 09.12	4	125	CSS917	CSS902
120 i (E81)	N46 B20 B, N46 B20 C	09.06 - 10.11	4	115	CSS924	---
120 i (E81, E87)	N43 B20 A, N46 B20B	09.04 - 09.12	4	110	---	CSS902
120 i (E87)	N46 B20 A, N46 B20 B	11.03 - 06.11	4	115	CSS924	---
120 i (E87)	N46 B20 B, N46 B20 BD	11.03 - 06.11	4	110	CSS924	---
120 i (F20)	N13 B16 A	03.15 ->	4	130	---	CSS920
120 i (F21)	N13 B16 A	03.15 ->	4	130	---	CSS920
120 i Cabriolet (E88)	N43 B20 A	03.08 - 12.13	4	120	CSS917	---
120 i Cabriolet (E88)	N43 B20 A	03.08 - 12.13	4	125	CSS917	---
120 i Cabriolet (E88)	N46 B20 B, N46 B20 C	03.08 - 12.13	4	115	CSS924	---
120 i Coupe (E82)	N46 B20 B	09.09 - 10.13	4	115	CSS924	---
120 i Coupe (E82)	N46 B20 B, N43 B20 A	10.07 - 10.13	4	125	CSS917	---
125 d (F20)	B47 D20 B	03.15 ->	4	165	---	CSS922
125 d (F21)	B47 D20 B	03.15 ->	4	165	---	CSS922
125 i Cabriolet (E88)	N52 B30 A	03.08 - 12.13	6	160	CSS923	---
125 i Coupe (E82)	N52 B30 A	10.07 - 10.13	6	160	CSS923	---
125 i Coupe (E82)	N53 B30 A	10.07 - 10.13	6	160	CSS912	---
130 i (E81)	N52 B30 A, N52 B30 B, N52 B30 BF	09.06 - 12.11	6	195	CSS923	---
130 i (E81)	N52 B30 A, N52 B30 B	09.06 - 12.11	6	190	CSS923	---
130 i (E81, E87)	N52 B30 A, -B, -BF	09.06 - 09.12	4	195	---	CSS902
130 i (E81, E87)	N52 B30, N52 B30 A	09.06 - 09.12	6	195	CSS912	---
130 i (E87)	N52 B30 A, N52 B30 AF	03.05 - 09.12	6	190	CSS923	---
130 i (E87)	N52 B30 A, N52 B30 AF	03.05 - 09.12	6	195	CSS923	---
135 i Cabriolet (E88)	N54 B30 A, N55 B30 A	03.08 - 12.13	6	225	CSS923	---
135 i Cabriolet (E88)	N54 B30 A	03.08 - 12.13	6	225	CSS912	---
135 i Coupe (E82)	N54 B30 A, N55 B30 A	10.07 - 10.13	6	225	CSS923	---
135 i Coupe (E82)	N54 B30 A	10.07 - 10.13	6	225	CSS912	---
214 d Active Tourer (F45)	B37 C15 A	07.14 ->	3	70	---	CSS922

Typ Type	Motornummer Engine-No.	Baujahr Year	Zyl. Cyl.	KW	Kurbelwellen- sensor Crankshaft S.	Nocken- wellensensor Camshaft S.
214 d Gran Tourer (F46)	B37 C15 A	10.14 ->	3	70	---	CSS922
216 d Active Tourer (F45)	B37 C15 A	03.14 ->	3	85	---	CSS922
216 d Gran Tourer (F46)	B37 C15 A	08.14 ->	3	85	---	CSS922
216 i Active Tourer (F45)	B38 A15 A	02.15 ->	3	75	---	CSS922
216 i Gran Tourer (F46)	B38 A15 A	09.14 ->	3	75	---	CSS922
218 d Active Tourer (F45)	B47 C20 A	11.13 ->	4	110	---	CSS922
218 d Active Tourer (F45)	B47 C20 A	11.13 ->	4	100	---	CSS922
218 d Cabriolet (F23)	B47 D20 A	07.15 ->	4	110	---	CSS922
218 d Cabriolet (F23)	B47 D20 A	07.15 ->	4	100	---	CSS922
218 d Coupe (F22, F87)	B47 D20 A	07.15 ->	4	110	---	CSS922
218 d Coupe (F22, F87)	B47 D20 A	07.15 ->	4	100	---	CSS922
218 d Gran Tourer (F46)	B47 C20 A	07.14 ->	4	110	---	CSS922
218 d Gran Tourer (F46)	B47 C20 A	07.14 ->	4	100	---	CSS922
218 d xDrive Active Tourer (F45)	B47 C20 A	12.14 ->	4	110	---	CSS922
218 d xDrive Active Tourer (F45)	B47 C20 A	12.14 ->	4	100	---	CSS922
218 i Active Tourer (F45)	B38 A15 A	11.13 ->	3	100	---	CSS922
218 i Gran Tourer (F46)	B38 A15 A	07.14 ->	3	100	---	CSS922
220 d Active Tourer (F45)	B47 C20 A	03.14 ->	4	120	---	CSS922
220 d Active Tourer (F45)	B47 C20 A, B47 D20 A	03.14 ->	4	140	---	CSS922
220 d Cabriolet (F23)	B47 D20 A	03.14 ->	4	140	---	CSS922
220 d Cabriolet (F23)	B47 D20 A	03.14 ->	4	120	---	CSS922
220 d Coupe (F22, F87)	B47 D20 A	03.14 ->	4	140	---	CSS922
220 d Coupe (F22, F87)	B47 D20 A	03.15 ->	4	120	---	CSS922
220 d Gran Tourer (F46)	B47 C20 A	09.14 ->	4	140	---	CSS922
220 d Gran Tourer (F46)	B47 C20 A	09.14 ->	4	120	---	CSS922
220 d xDrive (F45)	B47 D20 A	03.14 ->	4	140	---	CSS922
220 d xDrive Active Tourer (F45)	B47 C20 A	03.14 ->	4	120	---	CSS922
220 d xDrive Coupe (F22, F87)	B47 D20 A	06.14 ->	4	140	---	CSS922
220 d xDrive Gran Tourer (F46)	B47 C20 A	07.14 ->	4	140	---	CSS922
220 d xDrive Gran Tourer (F46)	B47 C20 A	07.14 ->	4	120	---	CSS922
220 i Active Tourer (F45)	B48 A20 A	03.14 ->	4	141	---	CSS922
220 i Active Tourer (F45)	B48 A20 A	03.14 ->	4	120	---	CSS922
220 i Gran Tourer (F46)	B48 A20 A	07.14 ->	4	141	---	CSS922
225 d Cabriolet (F23)	B47 D20 B	07.15 ->	4	165	---	CSS922
225 d Coupe (F22, F87)	B47 D20 B	07.15 ->	4	165	---	CSS922
225 i Active Tourer (F45)	B48 A20 B	11.13 ->	4	170	---	CSS922
225 i xDrive Active Tourer (F45)	B48 A20 B	03.14 ->	4	170	---	CSS922
225 xe Active Tourer (F45)	B38 A15 A	11.14 ->	3	165	---	CSS922
225 xe Active Tourer (F45)	B38 A15 A	11.14 ->	3	100	---	CSS922
316 Ci Coupe (E46)	M43 B16	04.00 - 07.06	4	77	---	CSS902
316 Ci Coupe (E46)	N45 B16 A	06.02 - 07.06	4	85	CSS924	---
316 Ci Coupe (E46)	N45 B18A	06.02 - 07.06	4	85	---	CSS902
316 g Compact (E36)	M43 B16	03.94 - 08.00	4	75	---	CSS902
316 i (E36)	M43 B16	09.93 - 04.99	4	75	CSS907	---
316 i (E36)	M40 B16	09.90 - 09.93	4	73	---	CSS902
316 i (E36)	M40 B16	09.90 - 09.93	4	75	---	CSS902
316 i (E36)	M43 B16	07.93 - 02.98	4	75	CSS907	CSS902
316 i (E46)	M43 164E3	09.98 - 02.05	4	77	CSS913	CSS902
316 i (E46)	M43 B16	04.00 - 02.05	4	77	CSS913	CSS902
316 i (E46)	N40 B16 A, N45 B16 A	06.02 - 02.05	4	85	CSS924	---
316 i (E46)	N42 B18 A, N46 B18 A	02.02 - 02.05	4	85	CSS924	CSS902
316 i (E46)	N45 B16 A	06.02 - 02.05	4	85	---	CSS902
316 i (E90)	N43 B16 A	09.07 - 12.11	4	90	CSS917	---
316 i (F30, F35, F80)	N13 B16 A	10.12 ->	4	100	CSS912	CSS920
316 i 3 Touring (F31)	N13 B16 A	03.13 ->	4	100	---	CSS920
316 i Cabriolet (E90)	N45 B16 A	03.05 - 10.11	4	85	CSS924	---
316 i Compact (E36)	M43 B16	03.94 - 08.00	4	75	CSS907	CSS902
316 i Coupe (E36)	M43 B16	09.93 - 04.99	4	75	---	CSS902
316 i Touring (E36)	M43 B16	01.96 - 10.99	4	75	---	CSS902

Typ Type	Motornummer Engine-No.	Baujahr Year	Zyl. Cyl.	KW	Kurbelwellen- sensor Crankshaft S.	Nocken- wellensensor Camshaft S.
316 i Touring (E46)	N42 B18 A, N46 B18 A	03.02 - 02.05	4	85	CSS924	CSS902
316 i Touring (E46)	N45 B16 A	06.02 - 02.05	4	85	CSS924	---
316 i Touring (E46)	N45 B16 A	06.02 - 02.05	4	85	---	CSS902
316 i Touring (E91)	N43 B16 A	05.08 - 05.12	4	90	CSS917	---
316 i Touring (F31)	N13 B16 A	03.13 ->	4	100	CSS912	---
316 ti Compact (E46)	N40 B16 A, N45 B16 A	06.02 - 02.05	4	85	CSS924	---
316 ti Compact (E46)	N42 B18 A, N46 B18 A	06.01 - 02.05	4	85	CSS924	CSS902
318 Ci Cabriolet (E46)	N42 B20 A, N46 B20 A	09.01 - 12.07	4	105	CSS924	---
318 Ci Cabriolet (E46)	N46 B20 A, N46 B20 B	02.05 - 12.07	4	110	CSS924	---
318 Ci Coupe (E46)	M43 B19	11.99 - 09.01	4	87	---	CSS902
318 Ci Coupe (E46)	N42 B20 A, N46 B20 A	12.00 - 05.06	4	105	CSS924	---
318 Ci Coupe (E46)	N46 B20 A	03.05 - 07.06	4	110	CSS924	---
318 d (E46)	M47 D20 (204D4)	03.03 - 02.05	4	85	CSS919	CSS916
318 d (E90)	M47 D20 (204D4)	09.05 - 12.11	4	90	CSS919	CSS918
318 d (F30, F80)	B47 D20 A	10.14 ->	4	110	---	CSS922
318 d Gran Turismo (F34)	B47 D20 A	07.15 ->	4	110	---	CSS922
318 d Touring (E46)	M47 D20 (204D4)	03.03 - 02.05	4	85	---	CSS916
318 d Touring (E91)	M47N 204 D4	09.05 - 06.12	4	90	CSS919	CSS918
318 d Touring (F31)	B47 D20 A	09.14 ->	4	110	---	CSS922
318 d xDrive Touring (F31)	B47 D20 A	03.15 ->	4	110	---	CSS922
318 i (E36)	M43 B18	10.93 - 02.98	4	85	CSS907	---
318 i (E46)	N42 B20 A, N46 B20 A	09.01 - 02.05	4	105	CSS924	---
318 i (E90)	N43 B20 A	09.07 - 12.11	4	105	CSS917	---
318 i (E90)	N46 B20 B	08.04 - 08.07	4	95	CSS924	CSS902
318 i (F30, F80)	B38 B15 A	03.15 ->	3	100	---	CSS922
318 i Cabriolet (E36)	M43 B18	01.94 - 04.99	4	85	CSS907	---
318 i Touring (E46)	N42 B20 A, N46 B20 A	09.01 - 02.05	4	105	CSS924	---
318 i Touring (E91)	N43 B20 A	09.07 - 06.12	4	105	CSS917	---
318 i Touring (E91)	N46 B20 B	01.06 - 08.07	4	95	CSS924	---
318 i Touring (F31)	B38 B15 A	01.15 ->	3	100	---	CSS922
318 td Compact (E46)	M47 D20 (204D4)	03.03 - 02.05	4	85	CSS919	CSS916
318 ti Compact (E46)	N42 B20 A, N46 B20 A	03.01 - 12.04	4	105	CSS924	---
320 Cd Cabriolet (E46)	M47 D20 (204D4)	02.05 - 12.07	4	110	CSS919	CSS916
320 Cd Coupe (E46)	M47 D20 (204D4)	11.03 - 07.06	4	110	CSS919	CSS916
320 Ci Cabriolet (E46)	M54 B22, M54 226S1	09.00 - 12.07	6	125	CSS913	CSS902
320 Ci Cabriolet (E46)	M54 B22, M54 226S1	09.00 - 12.07	6	125	CSS913	CSS904
320 Ci Coupe (E46)	M54 226S1	09.00 - 07.06	6	125	---	CSS902
320 Ci Coupe (E46)	M54 226S1	09.00 - 07.06	6	125	---	CSS904
320 Ci Coupe (E46)	M54 B	08.99 - 09.00	6	110	---	CSS902
320 Ci Coupe (E46)	M54 B	08.99 - 09.00	6	110	---	CSS904
320 d (E46)	M47 D20 (204D4)	09.01 - 02.05	4	110	CSS919	CSS916
320 d (E90)	M47 D20 (204D4)	09.05 - 12.11	4	110	CSS919	CSS918
320 d (E90)	M47 D20 (204D4), N47 D20C	01.05 - 12.11	4	120	CSS919	CSS918
320 d (F30, F80)	B47 D20 A	10.14 ->	4	140	---	CSS922
320 d Gran Turismo (F34)	B47 D20 A	07.15 ->	4	140	---	CSS922
320 d Touring (E46)	M47 D20 (204D4)	09.01 - 02.05	4	110	CSS919	CSS916
320 d Touring (E91)	M47 D20 (204D4)	09.01 - 02.05	4	110	CSS919	CSS918
320 d Touring (E91)	M47N 204 D5, N47 D20 A	09.05 - 06.12	4	120	---	CSS918
320 d Touring (F31)	B47 D20 A	09.14 ->	4	140	---	CSS922
320 d xDrive (F30, F80)	B47 D20 A	10.14 ->	4	140	---	CSS922
320 d xDrive (F31)	B47 D20 A	07.15 ->	4	140	---	CSS922
320 d xDrive Gran Turismo (F34)	B47 D20 A	07.15 ->	4	140	---	CSS922
320 i (E30)	M20 B 20	12.85 - 06.91	6	95	CSS905	---
320 i (E30)	M20 B 20	09.82 - 12.85	6	92	CSS905	---
320 i (E36)	M50 B	09.90 - 02.98	6	110	CSS906	---
320 i (E36)	M50 B	09.90 - 02.98	6	110	CSS901	CSS900
320 i (E46)	M52 B	03.98 - 09.00	6	110	CSS913	CSS902
320 i (E46)	M52 B	03.98 - 09.00	6	110	CSS913	CSS904
320 i (E46)	M54 226S1	09.00 - 02.05	6	125	CSS913	CSS902

Typ Type	Motornummer Engine-No.	Baujahr Year	Zyl. Cyl.	KW	Kurbelwellen- sensor Crankshaft S.	Nocken- wellensensor Camshaft S.
320 i (E46)	M54 226S1	09.00 - 02.05	6	125	CSS913	CSS904
320 i (E90)	N43 B20 A	09.07 - 12.11	4	125	CSS917	---
320 i (E90)	N46 B20 A, N46 B20 B	06.04 - 03.07	4	110	CSS924	---
320 i (E90)	N46 B20 B, N43 B20 A	03.07 - 12.11	4	115	CSS917	---
320 i (E90)	N46 B20 A, N46 B20C	01.05 - 03.07	4	110	---	CSS902
320 i (F30, F35, F80)	N13 B16 A	02.12 ->	4	125	CSS912	CSS920
320 i (F30, F80)	B48 B20 A	09.14 ->	4	135	---	CSS922
320 i Cabriolet (E30)	M20 B20	04.86 - 10.93	6	95	CSS905	---
320 i Cabriolet (E36)	M50 B	12.93 - 04.99	6	110	CSS901	CSS900
320 i Cabriolet (E36)	M50 B	12.93 - 04.99	6	110	CSS903	---
320 i Cabriolet (E36)	M50 B	12.93 - 04.99	6	110	CSS906	---
320 i Cabriolet (E93)	N43 B20 A	03.07 - 12.13	4	125	CSS917	---
320 i Coupe (E36)	M50 B	03.92 - 04.99	6	110	CSS906	---
320 i Coupe (E36)	M50 B	03.92 - 04.99	6	110	CSS901	CSS900
320 i Coupe (E92)	N43 B20 A	03.07 - 12.13	4	125	CSS917	---
320 i Coupe (E92)	N46 B20 A	11.06 - 06.07	4	110	CSS924	---
320 i Touring (E30)	M20 B 20	01.88 - 12.91	6	95	CSS905	---
320 i Touring (E36)	M52 B	01.95 - 10.99	6	110	CSS903	CSS900
320 i Touring (E46)	M52 B	10.99 - 09.00	6	110	CSS913	CSS902
320 i Touring (E46)	M52 B	10.99 - 09.00	6	110	CSS913	CSS904
320 i Touring (E46)	M54 226S1	09.00 - 02.05	6	125	CSS913	CSS902
320 i Touring (E46)	M54 226S1	09.00 - 02.05	6	125	CSS913	CSS904
320 i Touring (E91)	N43 B20 A	09.07 - 06.12	4	125	CSS917	---
320 i Touring (E91)	N46 B20 B	09.05 - 06.12	4	110	CSS924	---
320 i Touring (E91)	N46 B20 A, N46 B20C	09.05 - 06.12	4	110	---	CSS902
320 i Touring (F31)	B48 B20 A	10.14 ->	4	135	---	CSS922
320 i xDrive (F30, F80)	B48 B20 A	09.14 ->	4	135	---	CSS922
320 i xDrive Touring (F31)	B48 B20 A	09.14 ->	4	135	---	CSS922
320 si (E90)	N45 B20 A	09.05 - 08.06	4	127	CSS924	---
320 si (E90)	N45 B20 A	05.06 - 12.11	4	127	---	CSS902
320 td Compact (E46)	M47 D20 (204D4)	09.01 - 02.05	4	110	CSS919	CSS916
323 Ci Cabriolet (E46)	M52 B25	04.00 - 09.00	6	125	CSS913	CSS902
323 Ci Cabriolet (E46)	M54 B25	04.00 - 09.00	6	125	CSS913	CSS904
323 Ci Coupe (E46)	M52 B25	04.99 - 09.00	6	125	---	CSS902
323 Ci Coupe (E46)	M52 B25	04.99 - 09.00	6	125	---	CSS904
323 i (E46)	M52 B25	03.98 - 09.00	6	125	CSS913	CSS902
323 i (E46)	M52 B25	03.98 - 09.00	6	125	CSS913	CSS904
323 i (E90)	N52 B25 A	03.08 - 12.11	6	140	CSS923	---
323 i 2.5 (E36)	M52 B25	03.95 - 02.98	6	125	CSS903	CSS900
323 i Cabriolet 2.5 (E36)	M52 B25	06.95 - 04.99	6	125	CSS903	---
323 i Coupe 2.5 (E36)	M52 B25	03.95 - 04.99	6	125	CSS913	CSS900
323 i Coupe 2.5 (E36)	M52 B25	03.95 - 04.99	6	125	CSS903	---
323 i Touring 2.5 (E36)	M52 B25	09.95 - 10.99	6	125	CSS903	CSS900
323 ti Compact (E36)	M50 B25	08.97 - 08.00	6	125	CSS903	CSS900
325 Ci Cabriolet (E46)	M54 256S5	09.00 - 12.07	6	141	CSS913	CSS902
325 Ci Coupe (E46)	M54 256S5	09.00 - 07.06	6	141	CSS913	CSS902
325 Ci Coupe (E46)	M54 256S5	09.00 - 07.06	6	141	CSS913	CSS904
325 d (E90)	M57 D30 (306D3)	09.06 - 12.11	6	145	CSS919	CSS918
325 d Cabriolet (E93)	M57 D30 (306D3)	03.07 - 12.13	6	145	CSS919	CSS918
325 d Cabriolet (E93)	M57 D30 (306D3)	01.07 - 12.09	6	155	CSS919	---
325 d Coupe (E92)	---	01.07 - 12.09	6	155	CSS919	---
325 d Coupe (E92)	M57 D30 (306D3)	03.07 - 12.13	6	145	CSS919	CSS918
325 d Touring (E91)	M57 D30 (306D3)	09.06 - 06.12	6	145	CSS919	CSS918
325 e 2.7 (E30)	M20 B27	01.85 - 08.87	6	95	CSS905	---
325 e 2.7 (E30)	M20 B27	10.83 - 12.88	6	90	CSS905	---
325 i (E30)	M20 B25	12.86 - 06.91	6	125	CSS905	---
325 i (E30)	M20 B25	09.83 - 11.89	6	126	CSS905	---
325 i (E36)	M50 B25	09.90 - 09.95	6	141	CSS906	---
325 i (E46)	M54 256S5	09.00 - 02.05	6	141	CSS913	CSS902

Typ Type	Motornummer Engine-No.	Baujahr Year	Zyl. Cyl.	KW	Kurbelwellen- sensor Crankshaft S.	Nocken- wellensensor Camshaft S.
325 i (E46)	M54 256S5	09.00 - 02.05	6	141	CSS913	CSS904
325 i (E90)	N52 B25 A	01.05 - 12.11	6	160	CSS923	---
325 i (E90)	N52 B25 A	01.06 - 12.11	6	155	CSS923	---
325 i (E90)	N52 B25, N52 B25 A	01.05 - 12.11	6	160	CSS912	---
325 i (E90)	N52 B25 A	01.05 - 12.11	6	160	---	CSS902
325 i (E90)	N53 B30 A	03.07 - 12.11	6	160	CSS923	---
325 i (E91)	N53 B30 A	09.07 - 06.12	6	155	CSS923	---
325 i (E93)	N52 B25 A	03.07 - 12.13	6	160	CSS923	---
325 i Cabriolet (E30)	M20 B25	09.87 - 10.93	6	125	CSS905	---
325 i Cabriolet (E30)	M20 B25	12.87 - 12.87	6	126	CSS905	---
325 i Cabriolet (E36)	M56 B25	03.93 - 03.95	6	141	CSS906	---
325 i Cabriolet (E93)	N52 B25, N52 B25 A	03.07 - 12.13	6	160	CSS912	---
325 i Cabriolet (E93)	N53 B30 A	03.07 - 12.13	6	160	CSS923	---
325 i Cabriolet (E93)	N53 B30 A	10.06 - 12.13	6	155	CSS923	---
325 i Coupe (E36)	M50 B25	03.92 - 04.99	6	141	CSS906	---
325 i Coupe (E92)	---	05.05 - 06.13	6	155	CSS923	---
325 i Coupe (E92)	N52 B25 A	05.05 - 06.13	6	160	CSS923	---
325 i Coupe (E92)	N52 B25, N52 B25 A, N52 25C	09.06 - 12.13	6	160	CSS912	---
325 i Coupe (E92)	N53 B30 A	01.05 - 06.13	6	160	CSS923	---
325 i Coupe (E92)	N53 B30 A	01.05 - 06.13	6	155	CSS923	---
325 i Touring (E30)	M20 B25	07.87 - 03.93	6	125	CSS905	---
325 i Touring (E46)	M54 256S5	09.00 - 02.05	6	141	CSS913	CSS902
325 i Touring (E46)	M54 256S5	09.00 - 02.05	6	141	CSS913	CSS904
325 i Touring (E91)	N52 B25 A	12.04 - 12.10	6	160	CSS923	---
325 i Touring (E91)	N52 B25, N52 B25 A, N52 25C	09.05 - 06.12	6	160	CSS912	---
325 i Touring (E91)	N52 B25 A, N52 B25C	09.05 - 06.12	6	160	---	CSS902
325 i Touring (E91)	N53 B30 A	09.07 - 06.12	6	160	CSS923	---
325 i X (E30)	M20 B25	03.86 - 12.87	6	126	CSS905	---
325 i X (E30)	M20 B25	12.86 - 08.91	6	125	CSS905	---
325 i X Touring (E30)	M20 B25	06.88 - 10.93	6	125	CSS905	---
325 i xDrive (E90)	N53 B30 A	06.08 - 10.11	6	160	CSS923	---
325 i xDrive Coupe (E92)	N53 B30 A	09.08 - 12.13	6	160	CSS923	---
325 i xDrive Touring (E91)	N53 B30 A	09.07 - 06.12	6	160	CSS923	---
325 ti Compact (E46)	M54 256S5	06.01 - 02.05	6	141	CSS913	CSS904
325 xi (E46)	M54 256S5	09.00 - 02.05	6	141	CSS913	CSS902
325 xi (E46)	M54 256S5	09.00 - 02.05	6	141	CSS913	CSS904
325 xi (E90)	N52 B25 A	03.05 - 10.11	6	160	CSS923	CSS902
325 xi (E90)	N53 B30 A	03.07 - 06.08	6	160	CSS923	---
325 xi (E90)	N54 B30 A	09.07 ->	6	225	CSS912	---
325 xi (E91)	N53 B30 A	09.07 - 06.12	6	160	CSS923	---
325 xi Coupe (E92)	N52 B25 A	09.06 - 12.13	6	160	CSS923	---
325 xi Coupe (E92)	N52 B25 A, N52 B25C	09.06 - 12.13	6	160	CSS912	---
325 xi Coupe (E92)	N53 B30 A	09.07 - 12.13	6	160	CSS923	---
325 xi Touring (E46)	M54 256S5	09.00 - 02.05	6	141	CSS913	CSS902
325 xi Touring (E46)	M54 256S5	09.00 - 02.05	6	141	CSS913	CSS904
325 xi Touring (E91)	N52 B25 A	09.05 - 08.11	6	160	CSS923	---
325 xi Touring (E91)	N52 B25C	09.05 - 06.12	6	160	---	CSS902
325 xi Touring (E91)	N52 B25C	09.05 - 06.12	6	160	CSS912	---
328 Ci Coupe (E46)	M52 B28	04.99 - 06.00	6	142	CSS913	CSS902
328 i (E36)	M52 B28	01.95 - 02.98	6	142	---	CSS900
328 i (E46)	M52 B28	02.98 - 06.00	6	142	CSS913	CSS902
328 i (E46)	M52 B28	02.98 - 06.00	6	142	CSS913	CSS904
328 i Cabriolet (E36)	M52 B28	03.95 - 04.99	6	142	CSS903	CSS900
328 i Coupe (E36)	M52 B28	01.95 - 04.99	6	142	CSS903	CSS900
328 i Gran Turismo (F34)	N20 B20 A, N26 B20 A	08.12 - 02.15	4	180	---	CSS922
328 i Touring (E36)	M52 B28	01.95 - 10.99	6	142	CSS903	CSS900
328 i Touring (E46)	M52 B28	10.99 - 06.00	6	142	CSS913	CSS902
328 i Touring (E46)	M52 B28	10.99 - 06.00	6	142	CSS913	CSS904
328 i xDrive Gran Turismo (F34)	N20 B20 A, N26 B20 A	03.13 - 07.16	4	180	---	CSS922

Typ Type	Motornummer Engine-No.	Baujahr Year	Zyl. Cyl.	KW	Kurbelwellen- sensor Crankshaft S.	Nocken- wellensensor Camshaft S.
330 Cd Cabriolet (E46)	M57 D30 (306D2)	08.05 - 12.07	6	150	CSS919	CSS916
330 Cd Coupe (E46)	M57 D30 (306D2)	03.03 - 07.06	6	150	CSS919	CSS916
330 Ci Cabriolet (E46)	M54 306S3	06.00 - 12.07	6	170	CSS913	CSS902
330 Ci Cabriolet (E46)	M54 306S3	06.00 - 12.07	6	170	CSS913	CSS904
330 d (E46)	M57 D30 (306D2)	03.03 - 02.05	6	150	CSS919	CSS916
330 d (E46)	M57 D30, M57 D30 (306D1)	10.99 - 02.05	6	135	---	CSS916
330 d (E90)	M57 D30 TU2, M57 306 D3	09.05 - 12.11	6	170	CSS919	CSS918
330 d (E90)	M57N2 306 D3, N57 D30A	01.09 - 12.11	6	180	---	CSS918
330 d Cabriolet (E93)	M57 D30 (306D3)	03.07 - 12.13	6	170	CSS919	CSS918
330 d Coupe (E92)	M57 D30 TU2, M57 306 D3	09.06 - 12.13	6	170	CSS919	CSS918
330 d Touring (E46)	M57 D30 (306D2)	03.03 - 02.05	6	150	CSS919	CSS916
330 d Touring (E46)	M57 D30, M57 D30 (306D1)	11.99 - 02.05	6	135	---	CSS916
330 d Touring (E91)	M57 306 D3	09.05 - 06.12	6	170	CSS919	CSS918
330 d Touring (E91)	M57N2 306 D3, N57 D30A	01.09 - 06.12	6	180	---	CSS918
330 e (F30, F80)	B48 B20 A	02.15 ->	4	185	---	CSS922
330 e (F30, F80)	B48 B20 A	02.15 ->	4	135	---	CSS922
330 i (E46)	M54 306S3	06.00 - 02.05	6	170	CSS913	CSS902
330 i (E46)	M54 306S3	06.00 - 02.05	6	170	CSS913	CSS904
330 i (E90)	N52 B30 A, N52 B30 B	01.05 - 08.07	6	190	CSS923	---
330 i (E90)	N52 B30 A	01.05 - 12.11	6	190	---	CSS902
330 i (E90)	N53 B30 A	09.07 - 12.11	6	200	CSS923	---
330 i (F30, F80)	B46 B20 B, B48 B20 A	09.14 ->	4	185	---	CSS922
330 i Cabriolet (E93)	N52 B30 A	03.07 - 12.13	6	190	CSS923	---
330 i Cabriolet (E93)	N53 B30 A	03.07 . 12.13	6	200	CSS923	---
330 i Cabriolet (E93)	N53 B30, N52 B30 A, N53 B30 A	03.07 - 12.13	6	200	CSS912	---
330 i Coupe (E92)	N52 B30 A	09.06 - 12.13	6	190	CSS923	---
330 i Coupe (E92)	N52 B30 A, N52 B30 AF	09.06 - 02.10	6	200	CSS923	---
330 i Coupe (E92)	N53 B30, N52 B30 A	09.06 - 02.10	6	200	CSS912	---
330 i Gran Turismo (F34)	B48 B20 B	10.15 ->	4	185	---	CSS922
330 i Touring (E46)	M54 306S3	06.00 - 02.05	6	170	CSS913	CSS902
330 i Touring (E46)	M54 306S3	06.00 - 02.05	6	170	CSS913	CSS904
330 i Touring (E91)	N52 B30 A	09.05 - 08.07	6	190	CSS923	---
330 i Touring (E91)	N52 B30, N52 B30 A	09.05 - 08.07	6	190	CSS912	---
330 i Touring (E91)	N52 B30 A	09.05 - 08.07	6	190	---	CSS902
330 i Touring (E91)	N53 B30 A	09.07 - 06.12	6	200	CSS923	---
330 i Touring (F31)	B48 B20 A	09.14 ->	4	185	---	CSS922
330 i xDrive (E90)	N53 B30 A	09.08 - 12.11	6	200	CSS923	---
330 i xDrive (F30, F80)	B48 B20 A, B48 B20 B	10.14 ->	4	185	---	CSS922
330 i xDrive Coupe (E92)	N53 B30 A	09.08 - 12.13	6	200	CSS923	---
330 i xDrive Gran Turismo (F34)	B48 B20 B	10.15 ->	4	185	---	CSS922
330 i xDrive Touring (E91)	N53 B30 A	09.07 - 06.12	6	200	CSS923	---
330 i xDrive Touring (F31)	B48 B20 A, B48 B20 B	10.14 ->	4	185	---	CSS922
330 xd (E46)	M57 D30	06.00 - 02.05	6	135	---	CSS916
330 xd (E46)	M57 D30 (306D2)	03.03 - 02.05	6	150	CSS919	CSS916
330 xd (E90)	M57 D30 TU2, M57 306 D3	09.05 - 12.11	6	170	CSS919	CSS918
330 xd Coupe (E92)	M57 D30 TU2, M57 306 D3	09.06 - 12.13	6	170	CSS919	CSS918
330 xd Touring (E46)	M57 D30	06.00 - 02.05	6	135	---	CSS916
330 xd Touring (E46)	M57 D30 (306D2)	03.03 - 02.05	6	150	CSS919	CSS916
330 xd Touring (E91)	M57 306D3	09.05 - 06.12	6	170	---	CSS902
330 xd Touring (E91)	M57 D30 TU2, M57 306 D3	09.05 - 06.12	6	170	CSS919	CSS918
330 xi (E46)	M54 306S3	06.00 - 02.05	6	170	CSS913	CSS902
330 xi (E46)	M54 306S3	06.00 - 02.05	6	170	CSS913	CSS904
330 xi (E90)	N52 B30 A	01.05 - 08.07	6	190	CSS923	CSS902
330 xi (E90)	N53 B30 A	07.09 - 12.11	6	200	CSS923	---
330 xi Coupe (E46)	M54 306S3	06.00 - 07.06	6	170	CSS913	CSS902
330 xi Coupe (E46)	M54 306S3	06.00 - 07.06	6	170	CSS913	CSS904
330 xi Coupe (E92)	N52 B30 A	09.06 - 12.13	6	200	CSS923	---
330 xi Touring (E46)	M54 306S3	06.00 - 02.05	6	170	CSS913	CSS902
330 xi Touring (E46)	M54 306S3	06.00 - 02.05	6	170	CSS913	CSS904

Typ Type	Motornummer Engine-No.	Baujahr Year	Zyl. Cyl.	KW	Kurbelwellen- sensor Crankshaft S.	Nocken- wellensensor Camshaft S.
330 xi Touring (E91)	N52 B30 A	09.05 - 08.07	6	190	CSS923	CSS902
330 xi Touring (E91)	N53 B30 A	09.07 - 06.12	6	200	CSS923	---
335 d (E90)	M57 D30 (306D5)	09.06 - 12.11	6	210	CSS919	CSS918
335 d Coupe (E92)	M57 D30 (306D5)	09.06 - 12.13	6	210	CSS919	CSS918
335 d Touring (E91)	M57 D30 (306D5)	09.06 - 06.12	6	210	CSS919	CSS918
335 i (E90)	N54 B30 A, N55 B30 A	03.06 - 12.11	6	225	CSS923	---
335 i Cabriolet (E93)	N54 B30 A, N54 B30 B	05.06 - 10.13	6	225	CSS923	---
335 i Cabriolet (E93)	N54 B30 A, N54 B30B	03.07 - 12.13	6	225	CSS912	---
335 i Coupe (E92)	N54 B30 A, N55 B30 A	05.11 - 06.13	6	225	CSS923	---
335 i Coupe (E92)	N54 B30 A	09.06 - 12.13	6	225	CSS912	---
335 i Touring (E91)	N54 B30 A, N55 B30 A	03.06 - 05.12	6	225	CSS923	---
335 i Touring (E91)	N54 B30 A	09.06 - 06.12	6	225	CSS912	---
335 i xDrive (E90)	N54 B30 A, N55 B30 A	05.08 - 10.11	6	225	CSS923	---
335 i xDrive Touring (E91)	N54 B30 A, N55 B30 A	05.08 - 05.12	6	225	CSS923	---
335 xi (E90)	N54 B30 A, N55 B30 A	09.06 - 06.08	6	225	CSS923	---
335 xi Coupe (E92)	N54 B30 A, N55 B30 A	03.07 - 02.10	6	225	CSS923	---
335 xi Coupe (E92)	N54 B30 A	09.06 - 12.13	6	225	CSS912	---
335 xi Touring (E91)	N54 B30 A, N55 B30 A	09.06 - 08.08	6	225	CSS923	---
335 xi Touring (E91)	N54 B30 A	03.07 - 06.12	6	225	CSS912	---
340 i (F30, F80)	B58 B30 A	10.14 ->	6	240	---	CSS922
340 i (F30, F80)	B58 B30 A	10.14 ->	6	265	---	CSS922
340 i Gran Turismo (F34)	B58 B30 A	10.15 ->	6	240	---	CSS922
340 i Gran Turismo (F34)	B58 B30 A	09.15 ->	6	265	---	CSS922
340 i Touring (F31)	B58 B30 A	10.14 ->	6	240	---	CSS922
340 i Touring (F31)	B58 B30 A	10.14 ->	6	265	---	CSS922
340 i xDrive (F30, F80)	B58 B30 A	10.14 ->	6	265	---	CSS922
340 i xDrive Gran Turismo (F34)	B58 B30 A	10.15 ->	6	240	---	CSS922
340 i xDrive Gran Turismo (F34)	B58 B30 A	09.15 ->	6	265	---	CSS922
340 i xDrive Touring (F31)	B58 B30 A	10.14 ->	6	240	---	CSS922
340 i xDrive Touring (F31)	B58 B30 A	10.14 ->	6	265	---	CSS922
418 d Coupe (F32, F82)	B47 D20 A	03.15 ->	4	110	---	CSS922
418 d Coupe (F32, F82)	B47 D20 A	03.15 ->	4	100	---	CSS922
418 d Gran Coupe (F36)	B47 D20 A	07.15 ->	4	110	---	CSS922
418 d Gran Coupe (F36)	B47 D20 A, N47 D20 C	03.14 ->	4	100	---	CSS922
418 i Gran Coupe (F36)	B38 B15 A	07.15 ->	3	100	---	CSS922
420 d Cabriolet (F33, F83)	B47 D20 A	07.15 ->	4	140	---	CSS922
420 d Cabriolet (F33, F83)	B47 D20 A, N47 D20 C	10.13 ->	4	120	---	CSS922
420 d Coupe (F32, F82)	B47 D20 A	03.15 ->	4	140	---	CSS922
420 d Coupe (F32, F82)	B47 D20 A, N47 D20 C	07.13 ->	4	120	---	CSS922
420 d Gran Coupe (F36)	B47 D20 A	03.15 ->	4	140	---	CSS922
420 d Gran Coupe (F36)	B47 D20 A, N47 D20 C	03.14 ->	4	120	---	CSS922
420 d xDrive Coupe (F32, F82)	B47 D20 A	03.15 ->	4	140	---	CSS922
420 d xDrive Coupe (F32, F82)	B47 D20 A, N47 D20 C	11.13 ->	4	120	---	CSS922
420 d xDrive Gran Coupe (F36)	B47 D20 A	03.15 ->	4	140	---	CSS922
420 d xDrive Gran Coupe (F36)	B47 D20 A, N47 D20 C	03.14 ->	4	120	---	CSS922
420 i Cabriolet (F33, F83)	B48 B20 A	02.16 ->	4	135	---	CSS922
420 i Cabriolet (F33, F83)	N20 B20 B	07.14 ->	4	135	---	CSS922
420 i Cabriolet (F33, F83)	N20 B20 B	07.14 ->	4	120	---	CSS922
425 d Cabriolet (F33, F83)	B47 D20 B	03.16 ->	4	165	---	CSS922
425 d Cabriolet (F33, F83)	N47 D20 D	07.14 ->	4	160	---	CSS922
425 d Gran Coupe (F36)	B47 D20 B	03.16 ->	4	165	---	CSS922
425 d Gran Coupe (F36)	B47 D20 B	03.16 ->	4	155	---	CSS922
428 i Cabriolet (F33, F83)	N20 B20 A, N26 B20 A	10.13 ->	4	180	---	CSS922
428 i Gran Coupe (F36)	N20 B20 A, N26 B20 A	03.14 ->	4	180	---	CSS922
428 i xDrive Gran Coupe (F36)	N20 B20 A, N26 B20 A	03.14 ->	4	180	---	CSS922
430 i Cabriolet (F33, F83)	B48 B20 B	03.16 ->	4	185	---	CSS922
430 i Gran Coupe (F36)	B48 B20 B	03.16 ->	4	185	---	CSS922
430 i xDrive Cabriolet (F33, F83)	B48 B20 B	03.16 ->	4	185	---	CSS922
430 i xDrive Gran Coupe (F36)	B48 B20 B	03.16 ->	4	185	---	CSS922

Typ Type	Motornummer Engine-No.	Baujahr Year	Zyl. Cyl.	KW	Kurbelwellen- sensor Crankshaft S.	Nocken- wellensensor Camshaft S.
440 i Cabriolet (F33, F83)	B58 B30 A	03.16 ->	6	240	---	CSS922
440 i Cabriolet (F33, F83)	B58 B30 A	03.16 ->	6	265	---	CSS922
440 i Gran Coupe (F36)	B58 B30 A	03.16 ->	6	240	---	CSS922
440 i Gran Coupe (F36)	B58 B30 A	03.16 ->	6	265	---	CSS922
440 i xDrive Cabriolet (F33, F83)	B58 B30 A	03.16 ->	6	240	---	CSS922
440 i xDrive Cabriolet (F33, F83)	B58 B30 A	03.16 ->	6	265	---	CSS922
503 i Touring (F11)	N53 B30 A	07.11 - 06.13	6	200	CSS923	---
518 d (F10)	B47 D20 A	10.13 - 10.16	4	110	---	CSS922
518 d Touring (F11)	B47 D20 A	01.14 ->	4	110	---	CSS922
518 g Touring (E34)	M43 B18	11.95 - 06.96	4	85	CSS907	---
518 i (E34)	M43 B18	08.89 - 09.95	4	85	CSS907	---
520 d (E60)	M47 D20 (204D4)	09.05 - 03.10	4	110	CSS919	CSS918
520 d (E60)	N47 D20 A, M47 D20 (204D4)	07.05 - 03.05	4	120	---	CSS918
520 d (E60)	N47 D20 A, M47 D20 (204D4), N47 D20C	09.07 - 03.10	4	130	---	CSS918
520 d (E60)	N47 D20 A, M47 D20 (204D4)	07.05 - 03.10	4	120	CSS919	---
520 d (F10)	B47 D20 A	10.13 - 10.16	4	140	---	CSS922
520 d (G30)	B47 D20 A	09.16 ->	4	140	---	CSS922
520 d (G30)	B47 D20 A	09.16 ->	4	120	---	CSS922
520 d Touring (E61)	N47 D20 A, M47 D20 (204D4)	09.05 - 12.10	4	110	CSS919	CSS918
520 d Touring (E61)	N47 D20 A, M47 D20 (204D4)	07.05 - 12.10	4	120	CSS919	CSS918
520 d Touring (E61)	N47 D20 A, N47 D20C	09.07 - 12.10	4	130	---	CSS918
520 d Touring (F11)	B47 D20 A	10.13 ->	4	140	---	CSS922
520 d Touring (G31)	B47 D20 A	03.17 ->	4	140	---	CSS922
520 d Touring (G31)	B47 D20 A	03.17 ->	4	120	---	CSS922
520 d xDrive (F10)	B47 D20 A	10.13 - 10.16	4	140	---	CSS922
520 d xDrive (G30)	B47 D20 A	09.16 ->	4	140	---	CSS922
520 d xDrive (G30)	B47 D20 A	09.16 ->	4	120	---	CSS922
520 d xDrive Touring (F11)	B47 D20 A	10.13 ->	4	140	---	CSS922
520 i (E28)	M20 B 20	08.85 - 12.87	6	95	CSS905	---
520 i (E34)	M20 B 20	01.88 - 08.91	6	95	CSS905	---
520 i (E39)	M52 B	01.96 - 09.00	6	110	CSS903	CSS900
520 i (E39)	M52 B	04.99 - 06.03	6	100	---	CSS902
520 i (E39)	M52 B	01.96 - 09.00	6	110	---	CSS902
520 i (E39)	M52 B	04.99 - 06.03	6	100	---	CSS904
520 i (E39)	M52 B	01.96 - 09.00	6	110	---	CSS904
520 i (E39)	M54 B22	09.00 - 06.03	6	125	CSS913	CSS902
520 i (E39)	M54 B22	09.00 - 06.03	6	125	CSS913	CSS904
520 i (E60)	M54 306S3	07.03 - 03.10	6	125	CSS913	CSS902
520 i (E60)	M54 306S3	07.03 - 03.10	6	125	CSS913	CSS904
520 i (E60)	N43 B20 A	09.07 - 03.10	4	125	CSS917	---
520 i (E60)	N46 B20 B	04.06 - 12.09	4	115	CSS924	---
520 i 24V (E34)	M50 B	09.89 - 09.95	6	110	CSS906	---
520 i 24V (E34)	M50 B	09.89 - 09.95	6	110	CSS901	---
520 i Touring (E34)	M50 B	11.91 - 01.97	6	110	CSS906	---
520 i Touring (E34)	M50 B	11.91 - 01.97	6	110	CSS901	---
520 i Touring (E39)	M52 B	01.97 - 09.00	6	110	CSS903	---
520 i Touring (E39)	M52 B	04.99 - 05.04	6	100	---	CSS902
520 i Touring (E39)	M52 B	01.97 - 09.00	6	110	CSS913	CSS902
520 i Touring (E39)	M52 B	01.97 - 09.00	6	110	CSS913	CSS904
520 i Touring (E39)	M54 B22	09.00 - 05.04	6	125	CSS913	CSS902
520 i Touring (E39)	M54 B22	09.00 - 05.04	6	125	CSS913	CSS904
520 i Touring (E61)	M54 226S1	06.04 ->	6	125	---	CSS902
520 i Touring (E61)	N43 B20 A	09.07 - 12.10	4	125	CSS917	---
523 i (E39)	M52 B25	11.95 - 09.00	6	125	CSS903	CSS900
523 i (E39)	M52 B25	11.95 - 09.00	6	125	CSS913	CSS902
523 i (E39)	M52 B25	11.95 - 09.00	6	125	CSS913	CSS904
523 i (E60)	N52 B25 A, N52 B25 B, N52 B25 BE	10.04 - 02.07	6	130	CSS923	---
523 i (E60)	N52 B25 A, N52 B25 BE	01.07 - 03.10	6	140	CSS923	---

Typ Type	Motornummer Engine-No.	Baujahr Year	Zyl. Cyl.	KW	Kurbelwellen- sensor Crankshaft S.	Nocken- wellensensor Camshaft S.
523 i (E60)	N52 B25, N52 B30 A	07.05 - 03.10	6	130	CSS912	---
523 i (E60)	N52 B25 A	01.07 - 03.10	6	140	---	CSS902
523 i (E61)	N52 B25 A	03.07 - 01.10	6	140	CSS923	---
523 i (F10)	N52 B25 A, N52 B25 AF	01.09 - 08.11	6	150	CSS923	---
523 i (F10)	N53 B30 A	06.09 - 08.11	6	150	CSS923	---
523 i Touring (E39)	M52 B25	01.97 - 09.00	6	125	CSS903	CSS902
523 i Touring (E39)	M52 B25	01.97 - 09.00	6	125	CSS913	CSS904
523 i Touring (E61)	N52 B25 A, N52 B25 B	10.04 - 02.07	6	130	CSS923	---
523 i Touring (E61)	N52 B25, N52 B30 A	07.05 - 12.10	6	130	CSS912	---
523 i Touring (F11)	N52 B25 A, N52 B25 AF	11.09 - 08.11	6	150	CSS923	---
523 i Touring (F11)	N53 B30 A	10.09 - 08.11	6	150	CSS923	---
525 d (E39)	M57 D25, M57 D25 (256D1)	02.00 - 06.00	6	120	---	CSS916
525 d (E60)	M57 306 D3	01.07 - 03.10	6	145	CSS919	CSS918
525 d (E60)	M57 D25 (256D1)	12.04 - 03.10	6	120	CSS919	CSS918
525 d (E60)	M57 D25 TU, M57N 256 D4	06.04 - 03.10	6	130	CSS919	CSS918
525 d Touring (E39)	M57 D25, M57 D25 (256D1)	02.00 - 05.04	6	120	---	CSS916
525 d Touring (E61)	M57 D25 TU, M57N 256 D4	06.04 - 12.10	6	130	CSS919	CSS918
525 d Touring (E61)	M57 D30 (306D3)	01.07 - 12.10	6	145	CSS919	CSS918
525 d Touring (E61)	M57N 256 D4	12.04 - 12.10	6	120	CSS919	CSS918
525 d xDrive (E60)	M57 D30 (306D3)	09.08 - 03.10	6	145	CSS919	CSS918
525 d xDrive Touring (E61)	M57 D30 (306D3)	09.08 - 12.10	6	145	CSS919	CSS918
525 e 2.7 (E28)	M20 B27	09.81 - 12.87	6	90	CSS905	---
525 e 2.7 (E28)	M20 B27	12.84 - 12.87	6	95	CSS905	---
525 e 2.7 (E28)	M20 B27	05.83 - 12.87	6	92	CSS905	---
525 i (E34)	M20 B25	01.88 - 08.91	6	125	CSS905	---
525 i (E39)	M54 256S5	09.00 - 06.03	6	141	CSS913	CSS902
525 i (E39)	M54 256S5	09.00 - 06.03	6	141	CSS913	CSS904
525 i (E60)	M54 256S5	09.03 - 03.10	6	141	CSS913	CSS902
525 i (E60)	M54 256S5	09.03 - 03.10	6	141	CSS913	CSS904
525 i (E60)	N52 B25 A, N52 B25 B	10.04 - 12.09	6	160	CSS923	---
525 i (E60)	N52 B25, N52 B25 A	07.05 - 03.10	6	160	CSS912	---
525 i (E60)	N52 B25 A	07.05 - 03.10	6	160	---	CSS902
525 i (E60)	N52 B25 A	07.05 - 03.10	6	160	---	CSS904
525 i (E60)	N53 B30 A	01.07 - 03.10	6	160	CSS923	CSS902
525 i (E61)	N53 B30 A	01.07 - 12.10	6	160	CSS923	---
525 i 24V (E34)	M50 B25	09.89 - 09.95	6	141	CSS906	---
525 i Touring (E34)	M50 B25	11.91 - 01.97	6	141	CSS906	---
525 i Touring (E39)	M54 256S5	09.00 - 05.04	6	141	CSS913	CSS902
525 i Touring (E39)	M54 256S5	09.00 - 05.04	6	141	CSS913	CSS904
525 i Touring (E61)	M54 256S5	09.00 - 05.04	6	141	CSS913	CSS902
525 i Touring (E61)	M54 256S5	09.00 - 05.04	6	141	CSS913	CSS904
525 i Touring (E61)	N52 B25 A, N52 B25 B	10.04 - 03.10	6	160	CSS923	---
525 i Touring (E61)	N52 B25, N52 B25 A	07.05 - 03.10	6	160	CSS912	---
525 i Touring (E61)	N52 B25 A	07.05 - 12.10	6	160	---	CSS902
525 i Touring (E61)	N53 B30, N53 B30 A	01.07 - 12.10	6	160	---	CSS902
525 i X 24V (E34)	M52 B25	10.91 - 09.95	6	141	CSS906	---
525 i X Touring (E34)	M50 B25	02.92 - 01.97	6	141	CSS906	---
525 i xDrive (E60)	N53 B30 A	09.08 - 03.10	6	160	CSS923	---
525 i xDrive Touring (E61)	N53 B30 A	09.08 - 12.10	6	160	CSS923	---
525 xd (E60)	M57 306 D3	01.07 - 03.10	6	145	CSS919	CSS918
525 xd Touring (E61)	M57 306 D3	01.07 - 12.10	6	145	CSS919	CSS918
525 xi (E60)	N52 B25 A	07.05 - 03.10	6	160	CSS923	---
525 xi (E60)	N53 B30 A	01.07 - 03.10	6	160	CSS923	---
525 xi (E61)	N53 B30 A	01.07 - 12.10	6	160	CSS923	---
525 xi Touring (E61)	N52 B25 A	07.05 - 12.10	6	160	CSS923	---
528 i (E39)	M52 B28	11.95 - 09.00	6	142	CSS903	CSS902
528 i (E39)	M52 B28	11.95 - 09.00	6	142	CSS913	CSS904
528 i (F10)	N20 B20 A	10.10 - 10.16	4	180	CSS923	CSS922
528 i (F10)	N53 B30 A	01.09 - 08.11	6	190	CSS923	---

Typ Type	Motornummer Engine-No.	Baujahr Year	Zyl. Cyl.	KW	Kurbelwellen- sensor Crankshaft S.	Nocken- wellensensor Camshaft S.
528 i (F11)	N20 B20 A	10.10 ->	4	180	CSS923	CSS922
528 i Gran Turismo (F07)	N20 B20 A	01.13 ->	4	180	---	CSS922
528 i Touring (E39)	M52 B28	01.97 - 09.00	6	142	CSS903	CSS902
528 i Touring (E39)	M52 B28	01.97 - 09.00	6	142	CSS913	CSS904
528 i Touring (F11)	N53 B30 A	11.09 - 08.11	6	190	CSS923	---
528 i xDrive (F10)	N20 B20 A	10.10 - 10.16	4	180	---	CSS922
528 i xDrive Touring (F11)	N20 B20 A	03.11 ->	4	180	---	CSS922
530 d (E39)	M57 D30	08.98 - 09.00	6	135	---	CSS916
530 d (E39)	M57 D30	09.00 - 06.03	6	142	---	CSS916
530 d (E60)	M57 306 D3	07.03 - 03.10	6	170	CSS919	CSS918
530 d (E60)	M57 D30 (306D2)	07.03 - 03.10	6	160	CSS919	CSS916
530 d (E60)	M57 D30 (306D2), M57 D30	07.03 - 03.10	6	155	CSS919	---
530 d (E60)	M57 D30 (306D3)	01.07 - 03.10	6	173	CSS919	CSS918
530 d (G30)	B57 D30 A	09.16 ->	6	195	---	CSS922
530 d Touring (E39)	M57 D30	08.98 - 09.00	6	135	---	CSS916
530 d Touring (E39)	M57 D30 (306D1)	09.00 - 05.04	6	142	---	CSS916
530 d Touring (E61)	M57 306 D3	07.05 - 12.10	6	170	CSS919	CSS918
530 d Touring (E61)	M57 D30 (306D2)	06.04 - 12.10	6	160	CSS919	CSS916
530 d Touring (E61)	M57 D30 (306D3)	01.07 - 12.10	6	173	CSS919	CSS918
530 d Touring (G31)	B57 D30 A	03.17 ->	6	195	---	CSS922
530 d xDrive (E60)	M57 D30 (306D3)	09.08 - 03.10	6	173	CSS919	CSS918
530 d xDrive (G30)	B57 D30 A	09.16 ->	6	195	---	CSS922
530 d xDrive (G30)	B57 D30 A	09.16 ->	6	183	---	CSS922
530 d xDrive (G31)	B57 D30 A	03.17 ->	6	195	---	CSS922
530 d xDrive Touring (E61)	M57 D30 (306D3)	09.08 - 12.10	6	173	CSS919	CSS918
530 e iPerformance (G30)	B48 B20 B	03.17 ->	4	185	---	CSS922
530 i (E34)	M30 B30	01.88 - 08.91	6	138	CSS908	---
530 i (E39)	M54 306S3	09.00 - 06.03	6	170	CSS913	CSS902
530 i (E39)	M54 306S3	09.00 - 06.03	6	170	CSS913	CSS904
530 i (E60)	M54 306S3	07.03 - 03.10	6	170	CSS913	CSS902
530 i (E60)	M54 306S3	07.03 - 03.10	6	170	CSS913	CSS904
530 i (E60)	N52 B30 A, N52 B30 BF	09.04 - 02.07	6	190	CSS923	---
530 i (E60)	N52 B30, N52 B30 A	07.05 - 03.10	6	190	CSS912	---
530 i (E60)	N52 B30 A	03.05 - 03.10	6	187	CSS912	---
530 i (E60)	N52 B30 A	07.05 - 03.10	6	190	---	CSS902
530 i (E60)	N52 B30 A	07.05 - 03.10	6	190	---	CSS904
530 i (E60)	N53 B30 A	09.06 - 12.09	6	200	CSS923	---
530 i (E60)	N53 B30, N52 B30 A	01.07 - 03.10	6	200	---	CSS902
530 i (E61)	N53 B30 A	01.07 - 12.10	6	200	CSS923	---
530 i (F10)	N53 B30 A	05.11 - 06.13	6	200	CSS923	---
530 i (G30)	B46 B20 B, B48 B20 B	09.16 ->	4	185	---	CSS922
530 i Touring (E39)	M54 306S3	09.00 - 05.04	6	170	CSS913	CSS902
530 i Touring (E61)	M54 306S3	06.04 - 12.10	6	170	---	CSS902
530 i Touring (E61)	N52 B30, N52 B30 A	07.05 - 12.10	6	190	CSS912	---
530 i Touring (E61)	N52 B30 A	07.05 - 12.10	6	190	---	CSS902
530 i Touring (G31)	B48 B20 B	03.17 ->	4	185	---	CSS922
530 i Touring V8 (E34)	M60 B30	09.92 - 01.97	8	160	CSS909	---
530 i V8 (E34)	M60 B30	09.92 - 09.95	8	160	CSS909	---
530 i xDrive (E60)	N53 B30 A	07.09 - 12.09	6	200	CSS923	---
530 i xDrive (G30)	B46 B20 B, B48 B20 B	09.16 ->	4	185	---	CSS922
530 i xDrive Touring (E61)	N53 B30 A	09.08 - 12.10	6	200	CSS923	---
530 xd (E60)	M57 306 D3	07.05 - 03.10	6	170	CSS919	CSS918
530 xd (E60)	M57 D30 (306D3)	01.07 - 03.10	6	173	CSS919	CSS918
530 xd Touring (E61)	M57 306 D3	07.05 - 12.10	6	170	CSS919	CSS918
530 xd Touring (E61)	M57 306 D3	01.07 - 12.10	6	173	CSS919	CSS918
530 xi (E60)	N52 B30 A	09.04 - 02.07	6	190	CSS923	---
530 xi (E60)	N52 B30 A	07.05 - 03.10	6	190	CSS912	---
530 xi (E60)	N53 B30 A	11.05 - 08.07	6	200	CSS923	---
530 xi (E61)	N52 B30 A	01.07 - 12.10	6	200	CSS923	---

Typ Type	Motornummer Engine-No.	Baujahr Year	Zyl. Cyl.	KW	Kurbelwellen- sensor Crankshaft S.	Nocken- wellensensor Camshaft S.
530 xi Touring (E61)	N52 B30 A	07.05 - 12.10	6	190	CSS923	---
530 xi Touring (E61)	N52 B30 A	07.05 - 12.10	6	190	CSS912	---
535 d (E60)	M57 D30 (306D4)	09.04 - 03.10	6	200	CSS919	CSS918
535 d (E60)	M57 D30 (306D5)	01.07 - 03.10	6	210	CSS919	CSS918
535 d Touring (E61)	M57 D30 (306D4)	09.04 - 12.10	6	200	CSS919	CSS918
535 d Touring (E61)	M57 D30 (306D5)	01.07 - 12.10	6	210	CSS919	CSS918
535 i (E34)	M30 B35	01.88 - 09.95	6	155	CSS908	---
535 i (E39)	M62 B(35 8 S1), M62 B35	04.96 - 03.99	8	173	CSS915	CSS910
535 i (E39)	M62 B(35 8 S2), M62 B35 TU	04.99 - 06.03	8	180	CSS915	CSS910
539 i Touring (E61)	N52 B30 A, N52 B30 BF	09.04 - 02.07	6	190	CSS923	---
540 i (E39)	M62 B44 (448S2)	04.96 - 06.03	8	210	CSS915	CSS910
540 i (G30)	B58 B30 A	09.16 ->	6	250	---	CSS922
540 i (G30)	B58 B30 A	09.16 ->	6	265	---	CSS922
540 i Touring (E34)	M60 B40	09.93 - 01.97	8	210	CSS909	---
540 i Touring (E39)	M62 B44 (448S2)	01.97 - 05.04	8	210	CSS915	CSS910
540 i V8 (E34)	M60 B40	09.92 - 09.95	8	210	CSS909	---
540 i xDrive (G30)	B58 B30 A	09.16 ->	6	250	---	CSS922
540 i xDrive (G30)	B58 B30 A	09.16 ->	6	265	---	CSS922
540 i xDrive Touring (G31)	B58 B30 A	03.17 ->	6	250	---	CSS922
540 i xDrive Touring (G31)	B58 B30 A	03.17 ->	6	265	---	CSS922
545 i (E60)	N62 B44	09.03 - 03.10	8	245	---	CSS902
545 i (E60)	N62 B44 A	09.03 - 03.10	8	245	CSS924	---
545 i Touring (E61)	N62 B44	06.04 - 12.10	8	245	---	CSS902
545 i Touring (E61)	N62 B44 A	06.04 - 12.10	8	245	CSS924	---
549 i (E60)	N62 B40 A	07.05 - 03.10	8	225	CSS924	---
550 i (E60)	N62 B48 A, N62 B48 B	07.05 - 03.10	8	270	CSS924	---
550 i Touring (E61)	N62 B48 A, N62 B48 B	07.05 - 12.10	8	270	CSS924	---
630 i (E63)	N52 B30, N52 B30 A	09.04 - 07.10	6	190	CSS912	---
630 i (E63)	N53 B30 A	07.07 - 07.10	6	200	CSS923	---
630 i Cabriolet (E63)	N52 B30, N52 B30 A	09.04 - 07.10	6	190	CSS912	---
630 i Cabriolet (E64)	N53 B30 A	07.07 - 07.10	6	200	CSS923	---
635 CSi E24	M30 B35	06.78 - 08.88	6	160	CSS908	---
635 d (E63)	M57 D30 (306D5)	07.07 - 07.10	6	210	CSS919	CSS918
635 d Cabriolet (E64)	M57 D30 (306D5)	07.07 - 07.10	6	210	CSS919	CSS918
645 Ci (E63)	N62 B44 A	01.04 - 08.05	8	245	CSS924	---
645 Ci (E63)	N62 B44, N62 B44A	01.04 - 08.05	8	245	---	CSS902
645 Ci Cabriolet (E63)	N62 B44, N62 B44A	04.04 - 08.05	8	245	---	CSS902
645 Ci Cabriolet (E64)	N62 B44 A	04.04 - 08.05	8	245	CSS924	---
650 i (E63)	N62 B48 B	07.05 - 07.10	8	270	CSS924	---
650 i (F12)	N63 B44 A	03.11 ->	8	300	CSS923	---
650 i (F13)	N63 B44 A	11.10 ->	8	300	CSS923	---
650 i Cabriolet (E64)	N62 B48 B	07.05 - 07.10	8	270	CSS924	---
650 i Cabriolet (F12)	N63 B44 A, N63 B44 B	10.11 ->	8	330	CSS923	---
650 i Coupe (F13)	N63 B44 B	10.11 ->	8	330	CSS923	---
725 d, Ld (G11, G12)	B47 D20 B	09.15 ->	4	170	---	CSS922
728 i iL (E38)	M52 B28	08.95 - 11.01	6	142	CSS913	CSS900
728 i iL (E38)	M52 B28	08.95 - 11.01	6	142	CSS903	CSS902
730 d (E38)	M57 D30	08.98 - 04.00	6	135	---	CSS916
730 d (E38)	M57 D30 (306D1)	04.00 - 11.01	6	142	---	CSS916
730 d (E65, E66, E67)	M57 D30 (306D2)	10.02 - 07.08	6	160	CSS919	CSS916
730 d (E65, E66, E67)	M57 D30 (306D3)	10.02 - 07.08	6	155	CSS919	CSS918
730 d (G11, G12)	B57 D30 A	09.15 ->	6	195	---	CSS922
730 d (G11, G12)	B57 D30 A	09.15 ->	6	155	---	CSS922
730 d , Ld xDrive (G11, G12)	B57 D30 A	09.15 ->	6	195	---	CSS922
730 d xDrive (G11, G12)	B57 D30 A	09.15 ->	6	155	---	CSS922
730 i iL (E32)	M30 B30	12.86 - 09.94	6	138	CSS908	---
730 i iL (E38)	M60 B30	10.94 - 11.01	8	155	CSS909	CSS902
730 i iL (E38)	M60 B30	10.94 - 11.01	8	160	CSS909	CSS902
730 i iL V8 (E32)	M60 B30	04.92 - 09.94	8	160	CSS909	---

Typ Type	Motornummer Engine-No.	Baujahr Year	Zyl. Cyl.	KW	Kurbelwellen- sensor Crankshaft S.	Nocken- wellensensor Camshaft S.
730 i Li (E65, E66)	M54 306S3	03.03 - 08.06	6	170	CSS913	CSS902
730 i, Li (E65, E66)	N52 B30, N52 B30 A	03.05 - 07.08	6	190	CSS912	---
730 i, Li (F01, F02, F03, F04)	N52 B30 A, N52 B30 BF	06.08 - 12.15	6	190	CSS923	---
730 i, Li (G11, G12)	B48 B20 B	02.16 ->	4	190	---	CSS922
730 i, Li (E65, E66, E67)	N52 B30 A	03.05 - 07.08	6	190	CSS923	---
730 Ld (E65, E66, E67)	N57N 306 D2	07.05 - 12.09	6	170	CSS919	CSS918
735 i iL (E32)	M30 B35	09.86 - 09.92	6	155	CSS908	---
735 i iL (E32)	M30 B35	09.86 - 12.87	6	162	CSS908	---
735 i Li (E65, E66)	N62 B36	11.01 - 02.05	8	200	---	CSS902
735 i, iL (E38)	M62 B(35 8 S1), M62 B35	01.96 - 11.01	8	173	CSS915	CSS910
740 d (E38)	M67 D39	05.99 - 11.01	8	180	CSS915	CSS916
740 d (E65, E66, E67)	M67 D39 (398D1)	10.02 - 02.05	8	190	---	CSS916
740 d, Ld xDrive (G11, G12)	B57 D30 B	11.15 ->	6	235	---	CSS922
740 e, Le (G11, G12)	B48 B20 B	04.16 ->	4	240	---	CSS922
740 e, Le (G11, G12)	B48 B20 B	04.16 ->	4	190	---	CSS922
740 e, Le xDrive (G11, G12)	B48 B20 B	04.16 ->	4	240	---	CSS922
740 e, Le xDrive (G11, G12)	B48 B20 B	04.16 ->	4	190	---	CSS922
740 i (F01, F02)	N54 B30 A	10.08 - 12.15	6	240	CSS912	---
740 i (F01, F02, F03, F04)	N54 B30 A	10.08 - 12.15	6	240	CSS923	---
740 i, Li (G11, G12)	B58 B30 A	09.15 ->	6	240	---	CSS922
740 i iL (E38)	M60 B40	10.94 - 11.01	8	210	CSS909	---
740 i iL V8 (E32)	M60 B40	04.92 - 09.94	8	210	CSS909	---
740 i, Li xDrive (G11, G12)	B58 B30 A	03.16 ->	6	240	---	CSS922
740 i, iL (E38)	M62 B44 (448S2)	01.96 - 11.01	8	210	CSS915	CSS910
745 d (E65, E66, E67)	M67 D44 (448D1)	03.05 - 08.05	8	220	---	CSS918
745 d (E65, E66, E67)	M67 D44 (448D1)	07.05 - 07.08	8	242	---	CSS918
745 i Li (E65, E66)	N62 B44, N62 B44A	11.01 - 07.08	8	245	---	CSS902
750 d, Ld xDrive (G11, G12)	B57 D30 C	07.16 ->	6	294	---	CSS922
750 i (F01, F02)	N63 B44A	10.08 - 12.15	8	300	CSS912	---
750 i, Li xDrive (G11, G12)	N63 B44 C	09.15 ->	8	330	---	CSS922
750 i, iL (E38)	M73 B54 (54122)	12.94 - 11.01	12	240	CSS915	---
750 i, Li (G11, G12)	N63 B44 C	11.15 ->	8	330	---	CSS922
760 i, Li (E65, E66, E67)	N73 B60 A	01.03 - 07.08	12	327	CSS924	---
760 i, Li (E65, E66, E67)	N73 B60A	01.03 ->	12	327	---	CSS911
840 Ci (E31)	M62 B44, M62 B44 TU	01.96 - 12.99	8	210	CSS915	CSS910
840 i (E31)	M60 B40	02.93 - 02.96	8	210	CSS909	---
850 Ci (E31)	M73 B54, M73 B54 (54121)	09.94 - 12.99	12	240	CSS915	---
i3 Hybrid (I01)	IB1P25B, W20K06A	08.13 ->	2	75	CSS923	---
i3 Hybrid (I01)	IB1P25B, W20K06A	09.14 ->	2	125	CSS923	---
i8 Hybrid (I12)	B38 K15 A	03.14 ->	3	170	---	CSS922
M3 (E90)	S65 B40 A	03.07 - 12.11	8	309	CSS923	---
M3 4.0 (E90)	S65 B40 A	03.07 - 12.11	8	309	CSS915	---
M3 Cabriolet (E93)	S65 B40 A	03.07 - 12.13	8	309	CSS915	---
M3 Cabriolet (E93)	S65 B40 A	03.07 - 10.13	8	309	CSS923	---
M3 Coupe (E92)	S65 B40 A	03.07 - 12.13	8	309	CSS923	---
M3 Coupe (E92)	S65 B40 A	03.07 - 12.13	8	309	CSS915	---
M5 (E60)	S85 B50 A	09.04 - 03.10	10	373	CSS923	---
M5 4.9 (E39)	S62 B50, S38 B49	10.98 - 06.03	8	294	CSS915	---
M5 Touring (E61)	S85 B50 A	02.07 - 12.10	10	373	CSS915	---
M6 (E63)	S85 B50 A	09.05 - 07.10	10	373	CSS923	---
M6 (E63)	S85 B50 A	09.05 - 07.10	10	373	CSS915	---
M6 Cabriolet (E64)	S85 B50 A	07.06 - 07.10	10	373	CSS923	---
M6 Cabriolet (E64)	S85 B50 A	07.06 - 07.10	10	373	CSS915	---
M6 Cabriolet (F12)	S63 B44 B	01.12 ->	8	412	CSS923	---
M6 Cabriolet (F12)	S63 B44 B	02.14 ->	8	423	CSS923	---
M6 Cabriolet (F12)	S63 B44 B	07.15 ->	8	441	CSS923	---
M6 Coupe (F13)	S63 B44 B	01.12 ->	8	412	CSS923	---
M6 Coupe (F13)	S63 B44 B	02.14 ->	8	423	CSS923	---
M6 Coupe (F13)	S63 B44 B	07.15 ->	8	441	CSS923	---

Typ Type	Motornummer Engine-No.	Baujahr Year	Zyl. Cyl.	KW	Kurbelwellen- sensor Crankshaft S.	Nocken- wellensensor Camshaft S.
M6 Gran Coupe (F06)	S63 B44 B	12.12 ->	8	412	CSS923	---
M6 Gran Coupe (F06)	S63 B44 B	02.14 ->	8	423	CSS923	---
M6 Gran Coupe (F06)	S63 B44 B	07.15 ->	8	441	CSS923	---
X1 sDrive 16 d (F48)	B37 C15 A	11.14 ->	3	85	---	CSS922
X1 sDrive 18 d (F48)	B47 C20 A	11.14 ->	4	110	---	CSS922
X1 sDrive 18 d (F48)	B47 C20 A	11.14 ->	4	100	---	CSS922
X1 sDrive 18 d (F48)	B47 C20 A	11.14 ->	4	100	---	CSS922
X1 sDrive 18 i (E84)	N46 B20 B	01.10 - 06.15	4	110	CSS924	---
X1 sDrive 18 i (F48)	B38 A15 A	11.14 - 05.17	3	100	---	CSS922
X1 sDrive 20 d (F48)	B47 C20 A	01.15 ->	4	140	---	CSS922
X1 sDrive 20 d (F48)	B47 C20 A	01.15 ->	4	120	---	CSS922
X1 sDrive 20 i (F48)	B48 A20 A	11.14 ->	4	141	---	CSS922
X1 xDrive 18 d (F48)	B47 C20 A	11.14 ->	4	110	---	CSS922
X1 xDrive 20 d (F48)	B47 C20 A	11.14 ->	4	140	---	CSS922
X1 xDrive 20 d (F48)	B47 C20 A	11.14 ->	4	120	---	CSS922
X1 xDrive 20 i (F48)	B48 A20 A, B48 A20 B	11.14 ->	4	141	---	CSS922
X1 xDrive 25 d (F48)	B47 C20 B	11.14 ->	4	170	---	CSS922
X1 xDrive 25 i (E84)	N52 B30 A	01.10 - 06.15	6	160	CSS923	---
X1 xDrive 25 i (F48)	B46 A20 B, B48 A20 A	11.14 ->	4	170	---	CSS922
X1 xDrive 28 i (E84)	N20 B20 A	04.11 - 06.15	4	180	CSS923	---
X1 xDrive 28 i (E84)	N52 B30 A	10.09 - 06.15	6	190	CSS923	---
X3 2.0 d (E83)	M47 N204D4	10.04 - 12.10	4	110	---	CSS902
X3 2.0 d (E83)	N47 D20 A	09.07 - 03.09	4	130	---	CSS918
X3 2.0 i (E83)	N46 B20 B	07.05 - 08.08	4	110	CSS924	---
X3 2.0 i (E83)	N46 B20 A	07.05 - 08.08	4	110	---	CSS902
X3 2.5 i (E83)	M54 256S5	01.04 - 08.06	6	141	CSS913	CSS902
X3 2.5 i (E83)	M54 256S5	01.04 - 08.06	6	141	CSS913	CSS904
X3 2.5 si (E83)	N52 B25 A	09.06 - 08.08	6	160	CSS923	---
X3 2.5 si (E83)	N52 B25 A	09.06 - 08.08	6	160	CSS912	---
X3 2.5 si xDrive (E83)	N52 B25 A	07.06 - 12.08	6	155	CSS923	---
X3 3.0 d (E83)	M54 N306D2	01.04 - 08.05	6	150	---	CSS902
X3 3.0 d (E83)	M54 N306D2	01.04 - 08.05	6	150	---	CSS904
X3 3.0 d (E83)	M57 D30 (306D2)	01.04 - 08.05	6	150	CSS919	CSS916
X3 3.0 d (E83)	M57N2 306D2	01.04 - 08.08	6	160	CSS919	CSS918
X3 3.0 i (E83)	M54 306S3	01.04 - 08.06	6	170	CSS913	CSS902
X3 3.0 i (E83)	M54 306S3	01.04 - 08.06	6	170	CSS913	CSS904
X3 3.0 sd (E83)	M57 D30 (306D5)	09.06 - 08.08	6	210	CSS919	CSS918
X3 3.0 si (E83)	N52 B30 A	09.06 - 08.08	6	200	CSS923	---
X3 3.0 si (E83)	N52 B30 A	09.06 - 08.08	6	200	CSS912	---
X3 sDrive 18 d (F25)	B47 D20 A	02.14 ->	4	110	---	CSS922
X3 xDrive 20i (E83)	N46 B20 B	09.08 - 08.11	4	110	CSS924	---
X3 xDrive 28 i (F25)	N20 B20 A	08.11 ->	4	180	---	CSS922
X3 xDrive 28 i (F25)	N52 B30 A	04.11 ->	6	190	CSS923	---
X3 xDrive 30 d (E83)	M57 D30 (306D3)	09.08 - 04.11	6	155	CSS919	CSS918
X3 xDrive 30 d (E83)	M57 D30 (306D3)	09.08 - 04.11	6	160	CSS919	CSS918
X3 xDrive 35 d (E83)	M57 D30 (306D5)	09.08 - 08.11	6	210	CSS919	CSS918
X4 xDrive 20 d (F26)	B47 D20 A	07.13 ->	4	140	---	CSS922
X4 xDrive 20 d (F26)	B47 D20 A	07.13 ->	4	120	---	CSS922
X4 xDrive 28 i (F26)	N20 B20 A	05.13 ->	4	180	---	CSS922
X5 3.0 d (E53)	M57 D30 (306D1)	05.01 - 12.03	6	135	---	CSS916
X5 3.0 d (E53)	M57 D30 (306D2)	09.03 - 12.06	6	155	CSS919	---
X5 3.0 d (E53)	M57N 306 D4	12.03 - 12.06	6	160	CSS919	CSS916
X5 3.0 d (E70)	M57 D30 (306D3)	02.07 - 09.08	6	155	CSS919	CSS918
X5 3.0 d (E70)	M57 D30 (306D3)	02.07 - 09.08	6	173	CSS919	CSS918
X5 3.0 i (E53)	M54 306S3	05.00 - 12.06	6	170	CSS913	CSS904
X5 3.0 sd (E70)	M57 D30 (306D5)	09.07 - 02.09	6	210	CSS919	CSS918
X5 3.0 si (E70)	N52 B30 A, N52 B30 AF	02.06 - 09.08	6	200	CSS923	---
X5 3.0 si (E70)	N52 B30, N52 B30 A	02.07 - 09.08	6	200	CSS912	---
X5 sDrive 25 d (F15, F85)	B47 D20 B	07.15 ->	4	170	---	CSS922

Typ Type	Motornummer Engine-No.	Baujahr Year	Zyl. Cyl.	KW	Kurbelwellen- sensor Crankshaft S.	Nocken- wellensensor Camshaft S.
X5 xDrive 25 d (F15, F85)	B47 D20 B	07.15 ->	4	170	---	CSS922
X5 xDrive 30 d (E70)	N57 D30A	09.08 - 06.13	6	173	CSS919	CSS918
X5 xDrive 35 d (E70)	M57N 306 D5	09.08 - 06.13	6	210	---	CSS918
X5 xDrive 40e (F15, F85)	N20 B20 A	09.15 ->	4	230	---	CSS922
X5 xDrive 40e (F15, F85)	N20 B20 A	09.15 ->	4	180	---	CSS922
X5 xDrive 40e (F15, F85)	N20 B20 A	09.15 ->	4	205	---	CSS922
X5 xDrive 40e (F15, F85)	N20 B20 A	09.15 ->	4	155	---	CSS922
X5 xDrive30i (E70)	N52 B30 A	09.08 - 03.10	6	200	CSS912	---
X6 30 d (E71, E72)	M57N2 306 D3	05.08 - 08.08	6	173	CSS919	CSS918
X6 35 d (E71, E72)	M57 D30 (306D5)	05.08 - 08.08	6	210	CSS919	CSS918
X6 35i (E71)	N54 B30 A	05.08 - 08.08	6	225	CSS912	---
X6 50i (E71)	N63 B44A	05.08 - 06.14	8	300	CSS912	---
X6 xDrive 30 d (E71, E72)	N57 D30A	09.08 - 06.14	6	173	CSS919	CSS918
X6 xDrive 35 d (E71, E72)	M57 D30 (306D5)	09.08 - 06.14	6	210	CSS919	CSS918
X6 xDrive 35 i (E71, E72)	N54 B30 A	06.07 - 03.10	6	240	CSS923	---
X6 xDrive 35 i (E71, E72)	N54 B30 A, N55 B30 A	06.07 - 03.10	6	225	CSS923	---
Z1 2.5	M20 B25	06.88 - 06.91	6	125	CSS905	---
Z3 1.8	M43 B18	10.95 - 10.98	4	85	---	CSS902
Z3 1.9	M43 19E1	01.99 - 01.03	4	85	---	CSS902
Z3 1.9	M43 B 19, M43 194E1	07.98 - 01.03	4	87	CSS913	CSS902
Z3 1.9	M44 B19	10.95 - 03.99	4	103	---	CSS902
Z3 2.0	M52 B	04.99 - 01.03	6	110	---	CSS902
Z3 2.0	M52 B	04.99 - 01.03	6	110	CSS913	CSS904
Z3 2.2	M54 B22, M54 226S1	08.00 - 01.03	6	125	CSS913	CSS902
Z3 2.2	M54 B22, M54 226S1	08.00 - 01.03	6	125	CSS913	CSS904
Z3 2.8	M52 B28	04.97 - 06.00	6	141	CSS903	CSS902
Z3 2.8	M52 B28	04.97 - 06.00	6	141	CSS913	CSS904
Z3 3.0	M54 306S3	06.00 - 01.03	6	170	CSS913	CSS902
Z3 3.0	M54 306S3	06.00 - 01.03	6	170	CSS913	CSS904
Z3 Coupe 2.8	M52 B28	07.97 - 06.00	6	141	CSS903	CSS902
Z3 Coupe 2.8	M52 B28	07.97 - 06.00	6	141	CSS913	CSS904
Z3 Coupe 3.0	M54 306S3	06.00 - 06.03	6	170	CSS913	CSS902
Z3 Coupe 3.0	M54 306S3	06.00 - 06.03	6	170	CSS913	CSS904
Z4 2.0 i Roadster (E85)	N46 B20 A, N46 B20 B	03.05 - 02.09	4	110	CSS924	CSS902
Z4 2.2 i (E84)	M54 226S1	10.03 - 10.05	6	125	---	CSS902
Z4 2.2 i (E84)	M54 226S1	10.03 - 10.05	6	125	---	CSS904
Z4 2.5 i (E85)	M54 256S5	02.03 - 12.05	6	141	CSS913	CSS902
Z4 2.5 i (E85)	M54 256S5	02.03 - 12.05	6	141	CSS913	CSS904
Z4 2.5 i Roadster (E85)	N52 B25 A	09.05 - 02.09	6	130	CSS923	CSS902
Z4 2.5 si (E85)	N52 B25 A	09.05 - 02.09	6	160	CSS912	---
Z4 2.5 si Roadster (E85)	N52 B25 A	09.05 - 02.09	6	160	CSS923	---
Z4 3.0 i (E85)	M54 306S3	02.03 - 10.05	6	170	CSS913	CSS902
Z4 3.0 i (E85)	M54 B30 (30S6S3)	02.03 - 10.05	6	170	CSS913	CSS904
Z4 3.0 si (E85)	N52 B30, N52 B30 A	01.06 - 12.08	6	195	CSS912	---
Z4 3.0 si Coupe (E86)	N52 B30 A	03.06 - 01.09	6	195	CSS923	---
Z4 3.0 si Roadster (E85)	N52 B30 A	01.06 - 12.08	6	195	CSS923	---
Z4 sDrive 30 i Roadster (E89)	N52 B30 A	05.09 ->	6	190	CSS923	---
Z4 sDrive 35 i Roadster (E89)	N54 B30 A	05.09 ->	6	225	CSS923	---
Z4 sDrive 35 is Roadster (E89)	N54 B30 A	09.10 ->	6	250	CSS923	---
Z8 4.9 (E52)	S62 B50, S38 B49	06.00 - 06.03	8	294	CSS915	---

### Chevrolet

300 C 3.0 CRD	EXL	09.05 - 11.12	6	160	---	CSS407
300 C 3.0 V6 CRD	EXL	11.10 - 11.12	6	155	---	CSS407
300 C Touring 3.0 CRD	EXL	09.05 - 12.10	6	160	---	CSS407
Aveo 1.2	A 12 XEL	03.11 ->	4	51	CSS706	CSS722
Aveo 1.2	A 12 XER	03.11 ->	4	63	CSS706	CSS722
Aveo 1.2	F12S3	10.08 ->	4	53	CSS1401	---
Aveo 1.2	F12S3, B12S1, LY4	03.06 - 12.07	4	53	CSS1401	---

Typ Type	Motornummer Engine-No.	Baujahr Year	Zyl. Cyl.	KW	Kurbelwellen- sensor Crankshaft S.	Nocken- wellensensor Camshaft S.
Aveo 1.2 LPG	A 12 XER	11.12 ->	4	63	CSS706	CSS722
Aveo 1.3 D	LDV	07.11 ->	4	55	---	CSS716
Aveo 1.3 D	LSF	07.11 ->	4	70	---	CSS716
Aveo 1.4	A 14 XER	07.11 ->	4	74	CSS706	CSS722
Aveo 1.4	F14D3, L14	03.06 - 12.07	4	69	CSS1401	---
Aveo 1.4 Turbo	LUJ, LUV	08.13 ->	4	103	---	CSS722
Cruze 1.6	F16D3, LXT, LXV	05.09 ->	4	80	---	CSS715
Cruze 1.6	F16D4	05.09 ->	4	83	---	CSS715
Cruze 1.6	F16D4, LDE	05.09 ->	4	91	---	CSS715
Cruze 1.8	2H0, F18D4	05.09 ->	4	104	---	CSS715
Cruze 1.8 LPG	2H0, F18D4	06.11 ->	4	104	---	CSS715
Kalos 1.2	B12S1	03.05 ->	4	53	CSS1402	---
Kalos 1.2	B12S1, F12S3	04.03 ->	4	53	CSS1402	---
Kalos 1.2	F12S3	03.05 ->	4	53	CSS1402	---
Kalos 1.2	F12S3, B12S1	04.03 ->	4	53	CSS1401	---
Kalos 1.4 16V	F14D3	03.05 ->	4	69	CSS1401	---
Lacetti 1.4 16V	F14D3	03.05 ->	4	70	CSS1401	---
Matiz 0.8	F8CV	03.05 ->	3	38	CSS1401	---
Matiz 0.8	F8CV	03.05 ->	3	38	CSS1402	---
Matiz 0.8 LPG	F8CV	03.05 ->	3	38	CSS1401	---
Matiz 1.0	B10S	03.05 ->	4	47	CSS1401	---
Matiz 1.0	B10S	03.05 ->	4	47	CSS1402	---
Matiz 1.0	B10S1	03.05 ->	4	49	CSS1401	---
Matiz 1.0	B10S1	03.05 ->	4	49	CSS1402	---
Matiz 1.0 LPG	B10S1	03.05 ->	4	49	CSS1401	---
Nubira 1.4	F14D3	01.06 ->	4	70	CSS1401	---
Nubira 1.4	F14D3	01.05 ->	4	69	CSS1401	---
Orlando 1.8	2H0, F18D4	02.11 ->	4	104	---	CSS715
PT Cruiser 2.2 CRD	EDJ	03.02 - 12.10	4	89	---	CSS407
PT Cruiser 2.2 CRD	EDJ	08.05 - 12.10	4	110	---	CSS407
Spark 0.8	F8CV	05.05 ->	3	37	CSS1401	---
Spark 0.8	F8CV	05.05 ->	3	37	CSS1402	---
Spark 0.8	F8CV	09.00 - 12.04	3	38	CSS1401	---
Spark 1.0	B10D1	03.10 ->	4	50	CSS1402	---
Spark 1.0 LPG	B10D1	03.10 ->	4	50	CSS1402	---
Spark 1.0 SX	B10S1	05.05 ->	4	49	CSS1401	---
Spark 1.0 SX	LA2, B10S	05.05 ->	4	46	CSS1401	---
Spark 1.2	B12D1, LMU	03.10 ->	4	60	CSS1402	---
Spark 1.2 LPG	B12D1, LMU	03.10 ->	4	60	CSS1402	---
<b>Citroën</b>						
AX 1.4	KDX (TU3M/Z), KDY (TU3FM)	04.87 - 04.97	4	55	CSS1501	---
AX 1.4 4x4	KDY (TU3M), KDZ (TU3M/Z)	08.91 - 12.96	4	55	CSS1501	---
AX 1.4 GTI	KFY (TU3FJ2)	08.91 - 12.96	4	66	CSS1507	---
AX 1.4 GTI	KFZ (TU3FJ2)	06.91 - 12.96	4	69	CSS1502	---
AX 10	CDY (TU9M)	07.86 - 12.98	4	33	CSS1508	---
AX 10	CDY (TU9M)	02.87 - 12.98	4	37	CSS1508	---
AX 11	H1B, HDZ (TU1M)	09.86 - 12.97	4	44	CSS1507	---
AX 14	KDX (TU3M/Z), KDY (TU3FM)	04.87 - 04.97	4	55	CSS1508	---
AX 14 4x4	KDX (TU3M/Z), KDY (TU3FM)	08.91 - 12.96	4	55	CSS1508	---
Berlingo 1.1i	HDZ (TU1M), HFX (TU1JP)	07.96 ->	4	44	CSS1507	---
Berlingo 1.2 PureTech 110	---	02.16 ->	3	81	CSS1548	---
Berlingo 1.4 bivalent	KFW (TU3JP)	11.02 ->	4	48	CSS1518	---
Berlingo 1.4i	KFW (TU3JP), KFX (TU3JP)	07.96 ->	4	55	CSS1502	---
Berlingo 1.4i bivalent	KFW (TU3JP)	04.03 ->	4	55	CSS1518	---
Berlingo 1.6 16V	NFU (TU5JP4)	10.00 ->	4	80	CSS1515	---
Berlingo 1.6 BlueHDI 100	BHY (DV6FD)	12.14 ->	4	73	CSS1547	---
Berlingo 1.6 HDI 75	9HN (DV6ETED)	04.08 ->	4	55	CSS1538	CSS1510
Berlingo 1.6 HDi 75	9HW (DV6BTED4), DV6B	07.05 - 12.11	4	55	CSS1547	---

Typ Type	Motornummer Engine-No.	Baujahr Year	Zyl. Cyl.	KW	Kurbelwellen- sensor Crankshaft S.	Nocken- wellensensor Camshaft S.
Berlingo 1.6 HDI 75	DV6B	07.05 ->	4	55	CSS1517	CSS1510
Berlingo 1.6 HDi 75/BlueHDi 75	9HN (DV6ETED), BHW (DV6FE)	04.08 ->	4	55	CSS1547	---
Berlingo 1.6 HDi 90	9HP (DV6DTED)	07.10 ->	4	68	CSS1547	---
Berlingo 1.6 HDi 90	9HX (DV6ATED4)	04.08 ->	4	66	CSS1538	CSS1510
Berlingo 1.6 HDi 90	9HX (DV6ATED4), DV6ATED4	07.05 ->	4	66	CSS1517	CSS1510
Berlingo 1.6 HDi 110	9HL (DV6C), 9HR (DV6C)	07.10 ->	4	82	CSS1547	---
Berlingo 1.6 HDi 110	9HR (DV6C)	07.10 ->	4	82	CSS1538	---
Berlingo 1.6 HDi 110	9HW (DV6ETED), DV6B	08.05 ->	4	80	---	CSS1510
Berlingo 1.6 HDi 110	9HZ (DV6TED4)	04.08 ->	4	80	CSS1538	CSS1510
Berlingo 1.6 HDi 115	9HR (DV6C)	07.10 ->	4	84	CSS1547	---
Berlingo 1.6 BlueHDi 120	BHZ (DV6FC)	12.14 ->	4	88	CSS1547	---
Berlingo 1.6 VTi 95	5FK (EP6CB)	07.10 ->	4	72	CSS1545	---
Berlingo 1.6 VTi 95	5FK (EP6CB)	07.10 ->	4	72	---	CSS920
Berlingo 1.6 VTi 120	5FS (EP6C)	11.09 ->	4	88	CSS1545	CSS920
Berlingo 1.8 D	A9A (XUD7)	07.98 ->	4	43	CSS1504	---
Berlingo 1.8i	LFX (XU7JB)	05.97 ->	4	66	CSS1506	---
Berlingo 1.9 D	D9B (XUD9A/L), DJY (XUD9A)	07.96 ->	4	50	CSS1504	---
Berlingo 1.9 D	WJY (DW8B), WJZ (DW8)	07.98 - 10.05	4	51	CSS1514	---
Berlingo 2.0 HDi 90	RHY (DW10TD)	12.99 ->	4	66	CSS1514	CSS1510
Berlingo Box 1.6 BlueHDi 100	BHY (DV6FD)	12.14 ->	4	73	CSS1547	---
Berlingo Box 1.6 BlueHDi 120	BHZ (DV6FC)	12.14 ->	4	88	CSS1547	---
Berlingo Box 1.6 HDi 75	9HW (DV6BTED4), DV6B	07.05 - 12.11	4	55	CSS1547	---
Berlingo Box 1.6 HDi 90	9HF (DV6DTED)	07.10 ->	4	66	CSS1547	---
Berlingo Box 1.6 HDi 90	9HP (DV6DTED)	07.10 ->	4	68	CSS1547	---
Berlingo Box 1.6 HDi 110	9HL (DV6C), 9HR (DV6C)	07.10 ->	4	82	CSS1547	---
Berlingo Box 1.6 HDi 115	9HL (DV6C)	07.10 ->	4	84	CSS1547	---
Berlingo Box 1.6 HDi/BlueHDi 75	9HN (DV6ETED), BHW (DV6FE)	07.10 ->	4	55	CSS1547	---
Berlingo Box 1.6 VTi 120	5FS (EP6C)	11.09 ->	4	88	CSS1545	---
Berlingo Box 1.6 VTi 95	5FK (EP6CB)	07.10 ->	4	72	CSS1545	---
Berlingo Platform/Chassis 1.6 BlueHDi 100	BHY (DV6FD)	12.14 ->	4	73	CSS1547	---
Berlingo Platform/Chassis 1.6 HDi 92	9HJ (DV6DTEDM)	07.10 ->	4	68	CSS1547	---
BX 16E	BDY (XU5M), BDZ (XU5M)	05.89 - 02.93	4	65	CSS1501	---
C1 1.4 HDi	DV4D	06.05 ->	4	40	CSS1517	CSS1519
C1 II 1.0 VTi 68	1KR-FE	04.14 ->	3	51	CSS1548	---
C1 II 1.2 VTi 82	HMT (EB2D)	04.14 ->	3	60	CSS1548	---
C15 1.8 D	161A (XUD7)	07.86 - 12.00	4	44	CSS1504	---
C2 1.1	HFX (TU1JP)	09.03 ->	4	44	CSS1518	---
C2 1.4	KFV (TU3JP)	09.03 ->	4	54	CSS1518	---
C2 1.4 16V	KFU (ET3J4)	06.06 ->	4	65	CSS1518	---
C2 1.4 HDi	8HX (DV4TD)	09.03 ->	4	50	CSS1517	CSS1519
C2 1.6	NFU (TU5JP4)	09.03 ->	4	80	CSS1518	---
C3 1,6 HDi	9HZ (DV6TED4)	09.05 ->	4	80	CSS1517	CSS1510
C3 I 1.1i	HFX (TU1JP)	02.02 ->	4	44	CSS1518	---
C3 I 1.4	KFT (TU3A)	11.09 ->	4	54	CSS1518	---
C3 I 1.4 16V	KFU (ET3J4)	12.03 ->	4	65	CSS1518	---
C3 I 1.4 16V HDi	8HY (DV4TED4)	02.02 ->	4	66	CSS1517	CSS1510
C3 I 1.4 HDi	8HX (DV4TD)	02.02 ->	4	50	CSS1517	CSS1519
C3 I 1.4i bivalent	KFV (TU3JP)	02.02 ->	4	54	CSS1518	---
C3 I 1.6 16V	NFU (TU5JP4)	02.02 ->	4	80	CSS1518	---
C3 I 1.6 16V HDi	9HX (DV6ATED4)	10.05 ->	4	66	---	CSS1510
C3 I 1.6 16V HDi	9HX (DV6ATED4)	10.05 ->	4	66	CSS1517	CSS1510
C3 I 1.6 16V HDi	DV6TED4	09.05 ->	4	80	---	CSS1510
C3 I 1.6 16V HDi	DV6TED4	09.05 ->	4	80	CSS1517	CSS1510
C3 II 1.0 VTi 68	ZMZ (EB0)	08.12 ->	3	50	CSS1548	---
C3 II 1.1	HFX (TU1JP)	11.09 ->	4	44	CSS1518	---
C3 II 1.2 THP 110	HNZ (EB2DT)	10.14 ->	3	81	CSS1548	---
C3 II 1.2 VTi 82	HMZ (EB2F)	06.12 ->	3	60	CSS1548	---
C3 II 1.4 HDi 70	8HR (DV4C), 8HZ (DV4TD)	11.09 ->	4	50	---	CSS1519
C3 II 1.4 LPG	8FN (EP3)	06.13 ->	4	70	CSS1545	CSS920

Typ Type	Motornummer Engine-No.	Baujahr Year	Zyl. Cyl.	KW	Kurbelwellen- sensor Crankshaft S.	Nocken- wellensensor Camshaft S.
C3 II 1.4 VTi	8FR (EP3)	11.09 ->	4	72	---	CSS920
C3 II 1.4 VTi 95	8FP (EP3)	11.09 ->	4	70	CSS1545	CSS920
C3 II 1.4 VTi 95	8FR (EP3)	11.09 ->	4	72	CSS1545	---
C3 II 1.6 BlueHDi 75	BHW (DV6FE)	04.15 ->	4	55	CSS1547	---
C3 II 1.6 BlueHDi 100	BHY (DV6FD)	07.14 ->	4	73	CSS1547	---
C3 II 1.6 HDi	9HP (DV6DTED)	11.09 ->	4	68	CSS1547	CSS1510
C3 II 1.6 HDi 110	9HR (DV6C)	11.09 ->	4	82	CSS1547	---
C3 II 1.6 HDi 115	9HD (DV6C)	09.12 ->	4	84	CSS1547	---
C3 II 1.6 VTi 120	5FS (EP6C)	11.09 ->	4	88	CSS1545	---
C3 II 1.6 VTi 120	5FS (EP6C)	11.09 ->	4	88	CSS912	CSS920
C3 Picasso 1.2 THP 110	HNZ (EB2DT)	01.15 ->	3	81	CSS1548	---
C3 Picasso 1.4 VTi 95	8FN (EP3), 8FP (EP3), 8FS (EP3)	02.09 ->	4	70	CSS1545	---
C3 Picasso 1.4 VTi 95	8FS (EP3), 8FN (EP3), 8FP (EP3)	02.09 ->	4	70	CSS912	CSS920
C3 Picasso 1.4 VTi 95 LPG	8FN (EP3)	01.12 ->	4	70	CSS1545	CSS920
C3 Picasso 1.6 BlueHDi 100	BHY (DV6FD)	01.15 ->	4	73	CSS1547	---
C3 Picasso 1.6 HDi	9HX (DV6ATED4)	02.09 ->	4	80	CSS1538	CSS1510
C3 Picasso 1.6 HDi	9HZ (DV6TED4)	02.09 ->	4	66	CSS1538	CSS1510
C3 Picasso 1.6 HDi 90	9HP (DV6DTED)	07.10 ->	4	68	CSS1547	---
C3 Picasso 1.6 HDi 110	9HR (DV6C)	05.10 ->	4	82	CSS1547	---
C3 Picasso 1.6 HDi 115	9HD (DV6C)	01.13 ->	4	84	CSS1547	---
C3 Picasso 1.6 VTi 120	5FS (EP6C), 5FW (EP6)	02.09 ->	4	88	CSS1545	---
C3 Picasso 1.6 VTi 120	5FS (EP6C), 5FW (EP6)	02.09 ->	4	88	CSS912	CSS920
C3 Pluriel 1.4 HDi	8HX (DV4TD)	04.04 ->	4	50	CSS1517	CSS1519
C3 Pluriel 1.6	NFU (TU5JP4)	05.03 ->	4	80	CSS1518	---
C4 2.0 16V	RFJ (EW10A)	07.06 ->	4	103	---	CSS1511
C4 Aircross 1.6 HDi 115	9HD (DV6C)	04.12 ->	4	84	CSS1547	---
C4 Aircross 1.6 HDi 115 AWC	9HL (DV6C)	05.12 ->	4	84	CSS1547	---
C4 Cactus 1.2 THP 110	HNZ (EB2DT)	09.14 ->	3	81	CSS1548	---
C4 Cactus 1.2 VTi 75	HMU (EB2D)	09.14 ->	3	55	CSS1548	---
C4 Cactus 1.2 VTi 82	HMZ (EB2F)	09.14 ->	3	60	CSS1548	---
C4 Cactus 1.6 BlueHDi 100	BHY (DV6FD)	09.14 ->	4	73	CSS1547	---
C4 Cactus 1.6 HDi 90	9HP (DV6DTED)	09.14 ->	4	68	CSS1547	---
C4 Coupe 1.6 THP 150	5FX (EP6DT)	07.08 - 07.11	4	110	CSS1545	CSS920
C4 Coupe 1.6 VTi 120	5FW (EP6)	07.08 - 07.11	4	88	CSS1545	CSS920
C4 Grand Picasso 1.2 THP 130	HNY (EB2DTS)	04.14 ->	3	96	CSS1548	---
C4 Grand Picasso I 1.6 16V	5FT (EP6DT)	07.08 ->	4	103	CSS1545	CSS920
C4 Grand Picasso I 1.6 16V	5FX (EP6DT)	10.08 ->	4	110	CSS1545	CSS920
C4 Grand Picasso I 1.6 HDi 110	9HL (DV6C), 9HR (DV6C)	09.10 ->	4	82	CSS1547	---
C4 Grand Picasso I 1.6 THP 155	5FV (EP6CDT)	09.10 ->	4	115	CSS1545	CSS920
C4 Grand Picasso I 1.6 VTi 120	5FW (EP6)	07.08 ->	4	88	CSS1545	CSS920
C4 Grand Picasso I 1.8 i 16V	6FY (EW7A)	10.06 ->	4	92	---	CSS1511
C4 Grand Picasso I 1.8 i 16V	6FY (EW7A)	10.06 ->	4	92	CSS1522	CSS1511
C4 Grand Picasso I 2.0 HDi	RHJ-DW10BTED4	10.06 ->	4	100	CSS1539	---
C4 Grand Picasso I 2.0 i 16V	RFJ (EW10A)	10.06 ->	4	103	CSS1522	---
C4 Grand Picasso II 1.6 BlueHDi 100	BHY (DV6FD)	01.15 ->	4	73	CSS1547	---
C4 Grand Picasso II 1.6 BlueHDi 120	BHZ (DV6FC)	07.14 ->	4	88	CSS1547	---
C4 Grand Picasso II 1.6 HDi 90	9HP (DV6DTED)	09.13 ->	4	68	CSS1547	---
C4 Grand Picasso II 1.6 HDi/BlueHDi 115	9HC (DV6C), BHX (DV6FC)	09.13 ->	4	85	CSS1547	---
C4 Grand Picasso II 1.6 THP 155	5FV (EP6CDT)	09.13 ->	4	115	CSS1545	CSS920
C4 Grand Picasso II 1.6 THP 165	5GZ (EP6FDT)	07.14 ->	4	121	CSS1545	---
C4 Grand Picasso II 1.6 VTi 120	5FS (EP6C)	09.13 ->	4	88	CSS1545	CSS920
C4 Grand Picasso II 2.0 BlueHDi 135	AHV (DW10FD)	09.13 ->	4	100	CSS1546	---
C4 Grand Picasso II 2.0 BlueHDi 135 Hybrid	AHS (DW10FD)	09.13 ->	4	100	CSS1546	---
C4 Grand Picasso II 2.0 BlueHDi 150	AHX (DW10FD)	09.13 ->	4	110	CSS1546	---
C4 I 1.4 16V	KFU (ET3J4)	11.04 - 07.11	4	65	CSS1518	---
C4 I 1.6 16V	NFU (TU5JP4)	07.06 ->	4	80	CSS1518	---
C4 I 1.6 16V	NFU (TU5JP4)	11.04 - 07.11	4	80	CSS1518	---
C4 I 1.6 16V Bio-Flex	NFU (TU5JP4)	09.07 ->	4	80	CSS1518	---
C4 I 1.6 HDi	DV6TED4	07.06 ->	4	80	CSS1517	CSS1510

Typ Type	Motornummer Engine-No.	Baujahr Year	Zyl. Cyl.	KW	Kurbelwellen- sensor Crankshaft S.	Nocken- wellensensor Camshaft S.
C4 I 1.6 HDI	DV6TED4	11.04 - 07.11	4	80	CSS1517	---
C4 I 1.6 HDI 90	9HX (DV6ATED4)	11.04 - 07.11	4	66	---	CSS1510
C4 I 1.6 HDI 110	DV6TED4	11.04 - 07.11	4	80	---	CSS1510
C4 I 1.6 THP 140	5FT (EP6DT)	07.08 - 07.11	4	103	CSS1545	CSS920
C4 I 1.6 THP 150	5FX (EP6DT)	07.08 - 07.11	4	110	CSS1545	CSS920
C4 I 1.6 VTi 120	5FW (EP6)	07.08 - 07.11	4	88	CSS912	---
C4 I 2.0 16V	EW10A	11.04 ->	4	103	---	CSS1511
C4 I 2.0 16V	RFJ (EW10A)	11.04 ->	4	103	CSS1522	---
C4 I 2.0 16V	RFK (EW10J4S)	11.04 ->	4	130	CSS1522	---
C4 I 2.0 16V	RFN (EW10J4)	11.04 - 07.07	4	100	CSS1522	CSS1511
C4 I 2.0 HDi	DW10BTED4	11.04 - 07.11	4	100	CSS1539	---
C4 I 2.0 HDi	RHF (DW10BTED4)	07.08 - 07.11	4	103	CSS1539	---
C4 I 2.0 HDI	RHF(DW10BTED4)	07.08 - 07.11	4	103	---	CSS1510
C4 I 2.0 HDI 135	DW10BTED4	11.04 - 07.11	4	100	---	CSS1510
C4 II 1.2 THP 110	HNZ (EB2DT)	02.15 ->	3	81	CSS1548	---
C4 II 1.2 THP 130	HNY (EB2DTS)	04.14 ->	3	96	CSS1548	---
C4 II 1.4 VTi 95	8FP (EP3)	11.09 ->	4	70	CSS1545	CSS920
C4 II 1.6 BlueHDi 100	BHY (DV6FD)	07.14 ->	4	73	CSS1547	---
C4 II 1.6 BlueHDi 115	BHX (DV6FC)	08.14 ->	4	85	CSS1547	---
C4 II 1.6 BlueHDi 120	BHZ (DV6FC)	02.15 ->	4	88	CSS1547	---
C4 II 1.6 HDi 110	9HR (DV6C)	11.09 ->	4	82	CSS1547	---
C4 II 1.6 HDi 115	9HD (DV6C), 9HR (DV6C)	07.12 ->	4	84	CSS1547	---
C4 II 1.6 THP 155	5FV (EP6CDT)	11.09 ->	4	115	CSS1545	CSS920
C4 II 1.6 VTi 120	5FS (EP6C)	11.09 ->	4	88	CSS1545	CSS920
C4 II 1.6 VTi 120 LPG	5FS (EP6C)	09.11 ->	4	88	CSS1545	CSS920
C4 II 2.0 HDI 150	---	11.09 ->	4	110	---	CSS1510
C4 II HDi 90	9HP (DV6DTEd)	11.09 ->	4	68	CSS1547	---
C4 Picasso 1.2 THP 130	HNY (EB2DTS)	04.14 ->	3	96	CSS1548	---
C4 Picasso I 1.6 16V	5FX (EP6DT)	07.08 - 08.13	4	110	CSS1545	---
C4 Picasso I 1.6 16V	5FX (EP6DT)	07.08 - 08.13	4	110	CSS912	CSS920
C4 Picasso I 1.6 HDI	9HY (DV6TED4), 9HZ (DV6TED4)	02.07 - 08.13	4	80	CSS1517	CSS1510
C4 Picasso I 1.6 HDi 110	9HL (DV6C), 9HR (DV6C)	09.10 ->	4	82	CSS1538	---
C4 Picasso I 1.6 HDi 110	9HR (DV6C)	09.10 - 08.13	4	82	CSS1547	---
C4 Picasso I 1.6 THP 140	5FT (EP6DT)	07.08 - 08.13	4	103	CSS1545	CSS920
C4 Picasso I 1.6 THP 155	5FV (EP6CDT)	09.10 - 08.13	4	115	CSS1545	---
C4 Picasso I 1.6 THP 155	5FV (EP6CDT)	09.10 - 08.13	4	115	CSS912	CSS920
C4 Picasso I 1.6 VTi 120	5FW (EP6)	07.08 - 08.13	4	88	CSS1545	CSS920
C4 Picasso I 1.8 i 16V	6FY (EW7A)	02.07 - 12.11	4	92	CSS1522	CSS1511
C4 Picasso I 2.0 HDi	RHJ-DW10BTED4	02.07 - 08.13	4	100	CSS1539	---
C4 Picasso I 2.0 HDI 138	RHJ (DW10BTED4)	02.07 - 08.13	4	100	---	CSS1510
C4 Picasso I 2.0 HDI 150	---	07.09 - 08.13	4	110	---	CSS1510
C4 Picasso I 2.0 HDI 165	RHH (DW10CTED4)	09.10 - 08.13	4	120	---	CSS1510
C4 Picasso I 2.0 i 16V	RFJ (EW10A)	02.07 - 08.13	4	103	CSS1518	CSS1511
C4 Picasso II 1.2 THP 110	HNZ (EB2DT)	04.16 ->	3	81	CSS1548	---
C4 Picasso II 1.6 BlueHDi 120	BHZ (DV6FC)	07.14 ->	4	88	CSS1547	---
C4 Picasso II 1.6 BlueHDi 100	BHY (DV6FD)	12.14 ->	4	73	CSS1547	---
C4 Picasso II 1.6 HDi 90	9HP (DV6DTEd)	02.13 ->	4	68	CSS1547	---
C4 Picasso II 1.6 HDi/BlueHDi 115	9HC (DV6C), BHX (DV6FC)	02.13 ->	4	85	CSS1547	---
C4 Picasso II 1.6 THP 155	5FV (EP6CDT)	02.13 ->	4	115	CSS1545	CSS920
C4 Picasso II 1.6 THP 165	5GZ (EP6FDT)	07.14 ->	4	121	CSS1545	---
C4 Picasso II 1.6 VTi 120	5FS (EP6C)	02.13 ->	4	88	CSS1545	CSS920
C4 Picasso II 2.0 BlueHDi 135	AHV (DW10FD)	09.13 ->	4	100	CSS1546	---
C4 Picasso II 2.0 BlueHDi 135 Hybrid	AHS (DW10FD)	09.13 ->	4	100	CSS1546	---
C4 Picasso II 2.0 BlueHDi 150	AHX (DW10FD)	09.13 ->	4	110	CSS1546	---
C5 I 1.8 16V	6FZ (EW7J4)	03.01 - 08.04	4	85	CSS1513	CSS1511
C5 I 2.0 16V	RFN (EW10J4)	03.01 - 08.04	4	100	CSS1513	CSS1511
C5 I 2.0 16V	RFN (EW10J4)	03.01 - 08.04	4	100	CSS1513	---
C5 I 2.0 16V HPi	RLZ (EW10D)	03.01 - 08.04	4	103	CSS1513	CSS1512
C5 I 2.0 HDI	DW10BTED4	09.04 ->	4	100	CSS1539	CSS1510

Typ Type	Motornummer Engine-No.	Baujahr Year	Zyl. Cyl.	KW	Kurbelwellen- sensor Crankshaft S.	Nocken- wellensensor Camshaft S.
C5 I 2.0 HDI	RHY (DW10TD)	03.01 - 08.04	4	66	CSS1513	CSS1510
C5 I 2.0 HDi	RHZ (DW10ATED)	03.01 - 08.04	4	80	CSS1514	---
C5 I 2.0 HDi	RHZ (DW10ATED), RHS (DW10ATED)	03.01 - 08.04	4	79	CSS1513	---
C5 I 2.2 HDI	4HX (DW12TED4, FAP)	03.01 - 08.04	4	98	CSS1514	CSS1510
C5 I 3.0 V6	XFX (ES9J4S)	03.01 - 08.04	6	152	CSS1514	CSS1512
C5 II 1.6 HDI	DV6TED4	09.04 ->	4	80	---	CSS1510
C5 II 1.8 16V	6FY (EW7A)	09.05 ->	4	92	CSS1522	CSS1511
C5 II 1.8 16V	6FZ (EW7J4)	09.04 ->	4	85	CSS1522	CSS1511
C5 II 2.0 16V	EW10A	09.04 ->	4	103	---	CSS1511
C5 II 2.0 16V	RFJ (EW10A)	09.04 ->	4	103	CSS1522	---
C5 II 2.2 HDI	4HX (DW12TED4, FAP)	09.04 ->	4	98	CSS1513	CSS1510
C5 II 3.0 V6	XFV (ES9A)	09.04 ->	6	152	---	CSS1512
C5 III 1.6 HDI	DV6TED4	02.08 ->	4	80	CSS1517	CSS1510
C5 III 1.6 HDi 110	9HL (DV6C), 9HR (DV6C)	07.10 ->	4	82	CSS1547	---
C5 III 1.6 HDi 115	9HL (DV6C), 9HR (DV6C)	01.12 ->	4	84	CSS1547	---
C5 III 1.6 THP 150	5FN (EP6CDT)	07.10 ->	4	110	CSS1545	CSS920
C5 III 1.6 THP 155	5FV (EP6CDT)	04.09 ->	4	115	CSS1545	CSS920
C5 III 1.6 VTi 120	5FS (EP6C)	07.10 ->	4	88	CSS1545	CSS920
C5 III 1.8 16V	6FY (EW7A)	02.08 ->	4	92	CSS1522	CSS1511
C5 III 2.0 16V	RFJ (EW10A)	02.08 ->	4	103	---	CSS1511
C5 III 2.0 HDI	DW10BTED4	02.08 ->	4	100	---	CSS1510
C5 III 2.0 HDi	DW10BTED5	02.08 ->	4	100	CSS1539	---
C5 III 2.0 HDI 140	RHF (DW10BTED4)	04.09 ->	4	103	---	CSS1510
C5 III 2.0 HDI 165	RHH (DW10CTED4)	04.09 ->	4	120	---	CSS1510
C5 III 2.0 HDi 180	AHW (DW10FC)	03.15 ->	4	133	CSS1546	---
C5 III 2.2 HDI	4HT (DW12BTED4)	02.08 ->	4	125	CSS1538	CSS1510
C5 III 2.2 HDI 200	4HL (DW12C)	07.10 ->	4	150	---	CSS1510
C6 2.0 HDI	4HT (DW12BTED4)	06.06 ->	4	125	CSS1517	CSS1510
C6 2.2 HDI	4HT (DW12BTED4)	06.06 ->	4	125	---	CSS1510
C6 2.2 HDI	4HT (DW12BTED4)	06.06 ->	4	125	CSS1538	CSS1510
C6 3.0 V6	XFV (ES9A), XFX (ES9J4S)	09.05 ->	6	155	CSS1522	CSS1512
C8 2.0	RFN (EW10J4)	07.02 ->	4	100	CSS1516	CSS1511
C8 2.0 16V	RFJ (EW10A)	09.05 ->	4	103	CSS1516	CSS1511
C8 2.0 HDI	RHK (DW10UTED4)	02.07 ->	4	88	---	CSS1510
C8 2.0 HDi	RHK (DW10UTED4)	02.07 ->	4	88	CSS1539	---
C8 2.0 HDI	RHS (DW10ATED4 / FAP)	07.02 ->	4	79	CSS1516	CSS1510
C8 2.0 HDI 135	RHR (DW10BTED4)	03.06 ->	4	100	---	CSS1510
C8 2.2	3FZ (EW12J4)	07.02 ->	4	116	CSS1516	CSS1511
C8 2.2 HDI	4HT (DW12BTED4)	06.06 ->	4	125	CSS1517	CSS1510
C8 2.2 HDI	4HX (DW12TED4 / FAP)	07.02 ->	4	94	CSS1516	CSS1510
C8 3.0 V6	AFX (ES9J4S)	07.02 ->	6	150	CSS1522	CSS1512
C-Crosser 2.2 HDI	4HN (DW12MTED4)	02.07 ->	4	115	CSS1517	CSS1510
C-Crosser Enterprise 2.2 Hdi	4HN (DW12MTED4)	01.09 ->	4	115	CSS1517	---
C-Elysee 1.2 VTi 72	HMY (EB2M)	11.12 ->	3	53	CSS1548	---
C-Elysee 1.2 VTi 82	---	12.14 ->	3	60	CSS1548	---
C-Elysee 1.6 BlueHdi 100	BHY (DV6FD)	11.14 ->	4	73	CSS1547	---
C-Elysee 1.6 HDi 92	9HJ (DV6DTEDM), 9HP (DV6DTED)	11.12 ->	4	68	CSS1547	---
C-Elysee 1.6 VTi 115	NFP (EC5)	11.12 ->	4	85	CSS1518	---
DS 4 / DS 4 Crossback 1.6 THP 165	5GZ (EP6FDT)	07.15 ->	4	121	---	CSS920
DS 4 / DS 4 Crossback 1.6 THP 210	5GM (EP6FDTX)	07.15 ->	4	155	---	CSS920
DS3 1.2 THP 110	HNZ (EB2DT)	10.14 - 03.15	3	81	CSS1548	---
DS3 1.2 THP 110	HNZ (EB2DT)	04.15 ->	3	81	CSS1548	---
DS3 1.2 THP 130	HNY (EB2DTS)	09.15 ->	3	96	CSS1548	---
DS3 1.2 VTi 82	HMZ (EB2F)	01.13 - 03.15	3	60	CSS1548	---
DS3 1.2 VTi 82	HMZ (EB2F)	04.15 ->	3	60	CSS1548	---
DS3 1.2 VTi 82	HMZ (EB2F)	07.15 ->	3	60	CSS1548	---
DS3 1.4 VTi 95	8FP (EP3)	04.10 - 07.15	4	70	CSS1545	CSS920
DS3 1.4 VTi 95 LPG	8FN (EP3)	08.12 - 07.15	4	70	CSS1545	CSS920

Typ Type	Motornummer Engine-No.	Baujahr Year	Zyl. Cyl.	KW	Kurbelwellen- sensor Crankshaft S.	Nocken- wellensensor Camshaft S.
DS3 1.4 VTi 98	8FR (EP3)	11.09 - 07.15	4	72	CSS1545	CSS920
DS3 1.6 BlueHDi 75	BHW (DV6FE)	03.15 - 07.15	4	55	CSS1547	---
DS3 1.6 BlueHDi 75	BHW (DV6FE)	07.15 ->	4	55	CSS1547	---
DS3 1.6 BlueHDi 100	BHY (DV6FD)	07.14 - 07.15	4	73	CSS1547	---
DS3 1.6 BlueHDi 100	BHY (DV6FD)	04.15 ->	4	73	CSS1547	---
DS3 1.6 BlueHDi 100	BHY (DV6FD)	07.15 ->	4	73	CSS1547	---
DS3 1.6 BlueHDi 120	BHZ (DV6FC)	10.13 - 07.15	4	88	CSS1547	---
DS3 1.6 BlueHDi 120	BHZ (DV6FC)	07.15 ->	4	88	CSS1547	---
DS3 1.6 BlueHDi 120	BHZ (DV6FC)	07.15 ->	4	88	CSS1547	---
DS3 1.6 HDi 90	9HP (DV6DTED)	11.09 - 07.15	4	68	CSS1547	---
DS3 1.6 HDi 110	9HR (DV6C)	11.09 - 07.15	4	82	CSS1547	---
DS3 1.6 HDi 110	9HR (DV6C)	11.09 - 07.15	4	82	CSS1538	---
DS3 1.6 HDi 115	9HD (DV6C), 9HL (DV6C)	08.12 - 07.15	4	84	CSS1547	---
DS3 1.6 HDi 115	BHX (DV6FC)	10.13 - 07.15	4	85	CSS1547	---
DS3 1.6 Racing	5FD (EP6DTS)	02.11 - 07.15	4	152	CSS1545	CSS920
DS3 1.6 Racing	5FU (EP6CDTX)	02.11 - 07.15	4	147	CSS1545	CSS920
DS3 1.6 THP 150	5FN (EP6CDT), 5FX (EP6DT)	01.10 - 07.15	4	110	CSS1545	CSS920
DS3 1.6 THP 155	5FR (EP6DT), 5FV (EP6CDT)	04.10 - 07.15	4	115	CSS1545	CSS920
DS3 1.6 THP 165	5GZ (EP6FDT)	10.14 - 06.15	4	121	CSS1545	CSS920
DS3 1.6 THP 165	5GZ (EP6FDT)	07.15 ->	4	121	CSS1545	CSS920
DS3 1.6 THP 208	5GR (EP6FDTX)	09.15 ->	4	153	CSS1545	CSS920
DS3 1.6 VTi 120	5FS (EP6C)	04.10 - 07.15	4	88	CSS1545	CSS920
DS3 Cabriolet 1.2 THP 110	HNZ (EB2DT)	10.14 - 07.15	3	81	CSS1548	---
DS3 Cabriolet 1.2 THP 110	HNZ (EB2DT)	07.15 ->	3	81	CSS1548	---
DS3 Cabriolet 1.2 THP 130	HNY (EB2DTS)	09.15 ->	3	96	CSS1548	---
DS3 Cabriolet 1.2 VTi 82	HMZ (EB2F)	01.13 - 07.15	3	60	CSS1548	---
DS3 Cabriolet 1.6 BlueHDi 100	BHY (DV6FD)	07.14 - 07.15	4	73	CSS1547	---
DS3 Cabriolet 1.6 BlueHDi 115	BHX (DV6FC)	10.13 - 07.15	4	85	CSS1547	---
DS3 Cabriolet 1.6 BlueHDi 120	BHZ (DV6FC)	07.14 - 07.15	4	88	CSS1547	---
DS3 Cabriolet 1.6 HDi 90	9HP (DV6DTED)	01.13 - 07.15	4	69	CSS1547	---
DS3 Cabriolet 1.6 Racing	5FD (EP6DTS)	03.14 - 07.15	4	152	CSS1545	---
DS3 Cabriolet 1.6 THP 150	5FN (EP6CDT)	01.13 - 07.15	4	110	CSS1545	CSS920
DS3 Cabriolet 1.6 THP 155	5FV (EP6CDT)	01.13 - 07.15	4	115	CSS1545	CSS920
DS3 Cabriolet 1.6 THP 165	5GZ (EP6FDT)	10.14 - 07.15	4	121	CSS1545	---
DS3 Cabriolet 1.6 THP 165	5GZ (EP6FDT)	07.15 ->	4	121	CSS1545	CSS920
DS3 Cabriolet 1.6 THP 208	5GR (EP6FDTX)	09.15 ->	4	153	CSS1545	CSS920
DS3 Cabriolet 1.6 VTi 120	5FS (EP6C)	01.13 - 07.15	4	88	CSS1545	CSS920
DS4 1.2 THP 130	HNY (EB2DTS)	07.14 - 07.15	3	96	CSS1548	---
DS4 1.6 BlueHDi 115	BHX (DV6FC)	08.14 - 07.15	4	85	CSS1547	---
DS4 1.6 BlueHDi 120	BHZ (DV6FC)	07.14 - 07.15	4	88	CSS1547	---
DS4 1.6 HDi 110	9HR (DV6C)	04.11 - 07.15	4	82	CSS1547	---
DS4 1.6 HDi 115	9HD (DV6C), 9HL (DV6C)	08.12 - 07.15	4	84	CSS1547	---
DS4 1.6 HDi 90	9HP (DV6DTED)	05.11 - 07.15	4	68	CSS1547	---
DS4 1.6 THP 155	5FV (EP6CDT)	04.11 - 07.15	4	115	CSS1545	CSS920
DS4 1.6 THP 160	5FM (EP6DT)	04.12 - 07.15	4	120	CSS1545	CSS920
DS4 1.6 THP 165	5FM (EP6DT), 5GZ (EP6FDT)	01.12 - 07.15	4	121	CSS1545	CSS920
DS4 1.6 THP 200	5FU (EP6DTX)	04.11 - 07.15	4	147	CSS1545	CSS920
DS4 1.6 THP 210	5GM (EP6FDTX)	07.15 - 07.15	4	155	---	CSS920
DS4 1.6 VTi 120	5FS (EP6C)	04.11 - 07.15	4	88	CSS1545	CSS920
DS4 2.0 BlueHDi 150	AHX (DW10FD)	07.14 - 07.15	4	110	CSS1546	---
DS4 2.0 BlueHDi 180	AHW (DW10FC)	07.14 - 07.15	4	133	CSS1546	---
DS4 2.0 HDi 135	---	09.11 - 07.15	4	100	CSS1539	CSS1510
DS4 2.0 HDi 160	RHH (DW10CTED4)	04.11 ->	4	120	---	CSS1510
DS4/DS4 Crossback 1.2 THP 130	HNY (EB2DTS)	07.15 ->	3	96	CSS1548	---
DS4/DS4 Crossback 1.6 BlueHDi 100	BHY (DV6FD)	04.16 ->	4	73	CSS1547	---
DS4/DS4 Crossback 1.6 BlueHDi 120	BHZ (DV6FC)	07.15 ->	4	88	CSS1547	---
DS4/DS4 Crossback 1.6 THP 165	5GZ (EP6FDT)	07.15 ->	4	121	CSS1545	---
DS4/DS4 Crossback 2.0 BlueHDi 150	AHR (DW10FD)	07.15 ->	4	110	CSS1546	---
DS4/DS4 Crossback 2.0 BlueHDi 180	AHW (DW10FC)	07.15 ->	4	133	CSS1546	---

Typ Type	Motornummer Engine-No.	Baujahr Year	Zyl. Cyl.	KW	Kurbelwellen- sensor Crankshaft S.	Nocken- wellensensor Camshaft S.
DS5 1.6 BlueHDI 120	BHZ (DV6FC)	07.14 - 07.15	4	88	CSS1547	---
DS5 1.6 BlueHDI 120	BHZ (DV6FC)	07.15 ->	4	88	CSS1547	---
DS5 1.6 HDi	BHX (DV6FC)	11.13 - 07.15	4	85	CSS1547	---
DS5 1.6 HDi 110	9HR (DV6C)	11.11 - 07.15	4	82	CSS1547	---
DS5 1.6 HDi 115	9HD (DV6C)	06.12 - 07.15	4	84	CSS1547	---
DS5 1.6 THP 155	5FV (EP6CDT)	11.11 - 07.15	4	115	CSS1545	CSS920
DS5 1.6 THP 165	5FM (EP6DT), 5GZ (EP6FDT)	01.12 - 07.15	4	121	CSS1545	CSS920
DS5 1.6 THP 165	5GZ (EP6FDT)	07.15 ->	4	121	CSS1545	---
DS5 1.6 THP 165 Hybrid	5GZ (EP6FDT)	06.12 - 07.15	4	121	CSS1545	---
DS5 1.6 THP 200	5FU (EP6DTX)	11.11 - 07.15	4	147	CSS1545	CSS920
DS5 1.6 THP 210	5GM (EP6FDTX)	11.14 - 07.15	4	155	CSS1545	---
DS5 1.6 THP 210	5GM (EP6FDTX)	04.15 ->	4	155	CSS1545	CSS920
DS5 2.0 BlueHdi 150	AHR (DW10FD)	04.15 ->	4	110	CSS1546	---
DS5 2.0 BlueHdi 150	AHX (DW10FD)	07.14 - 07.15	4	110	CSS1546	---
DS5 2.0 BlueHdi 180	AHW (DW10FC)	08.13 - 07.15	4	133	CSS1546	---
DS5 2.0 BlueHDI 180	AHW (DW10FC)	04.15 ->	4	133	CSS1546	---
DS5 2.0 HDi 135	---	11.11 - 07.15	4	100	CSS1539	CSS1510
DS5 2.0 HDi 150 Hybrid	AHX (DW10FD)	11.11 - 07.15	4	110	CSS1546	---
DS5 2.0 HDi 165	RHH (DW10CTED4)	11.11 - 07.15	4	120	CSS1539	CSS1510
Evasion 1.8	LFZ (XU7JP)	05.97 - 07.02	4	73	CSS1501	---
Evasion 1.9 TD	D8B (XUD9TF)	10.95 - 12.98	4	68	CSS1504	---
Evasion 1.9 TD	D8B (XUD9TF)	11.94 - 07.02	4	66	CSS1504	---
Evasion 2.0	RFU (XU10J2/C)	06.94 - 07.02	4	89	CSS1500	---
Evasion 2.0 16V	RFN (EW10J4)	05.00 - 07.02	4	100	CSS1513	CSS1511
Evasion 2.0 16V	RFV (XU10J4R)	05.98 - 04.00	4	97	CSS1500	CSS1509
Evasion 2.0 HDI	RHZ (DW10ATED)	08.99 - 07.02	4	80	CSS1516	CSS1510
Evasion 2.0 Turbo C.T.	RGX (XU10J2TE)	06.94 - 07.02	4	108	CSS1500	---
Evasion 2.1 TD	P8C (XUD11BTE)	05.96 - 07.02	4	80	CSS1500	---
Jumper 1.9 D	D9B (XUD9A/U)	01.99 - 04.02	4	51	CSS1504	---
Jumper 1.9 TD	D8C (XUD9UTF)	08.94 - 04.02	4	66	CSS1504	---
Jumper 1.9 TD	D8C (XUD9UTF)	02.94 - 04.02	4	68	CSS1504	---
Jumper 2.0	RFW (XU10J2U)	02.94 - 04.02	4	80	CSS1500	---
Jumper 2.0	XU10J2	04.02 ->	4	81	CSS1513	CSS1511
Jumper 2.0 bivalent	XU10J2	02.03 ->	4	81	CSS1513	---
Jumper 2.0 BlueHDI 130	AHN (DW10FUD)	04.16 ->	4	96	CSS1546	---
Jumper 2.0 BlueHDI 130	AHN (DW10FUD)	07.15 ->	4	96	CSS1546	---
Jumper 2.0 BlueHDI 160	AHP (DW10FUC)	04.16 ->	4	120	CSS1546	---
Jumper 2.0 BlueHDI 160	AHP (DW10FUC)	07.15 ->	4	120	CSS1546	---
Jumper 2.0 HDi	RHV (DW10UTD)	04.02 ->	4	62	CSS1513	---
Jumper 2.2 HDi	4HY (DW12UTED)	04.02 ->	4	74	CSS1513	---
Jumper 2.5 D	T9A (DJ5)	08.94 - 04.02	4	63	CSS1504	---
Jumper 2.5 TD	T8A (DJ5T)	08.94 - 04.02	4	76	CSS1504	---
Jumper 2.5 TDI	THX (DJ5TED)	12.96 - 11.00	4	79	CSS1504	---
Jumpy 1.6 HDi 90	9HU (DV6UTED4)	01.07 ->	4	66	CSS1517	CSS1510
Jumpy 1.6 HDi 90 8V	9HH (DV6DUM), 9HM (DV6UC)	01.07 ->	4	66	CSS1547	---
Jumpy 1.9 D	D9B (XUD9A/U)	10.95 - 04.98	4	51	CSS1504	---
Jumpy 1.9 D 70	WJZ (DW8)	04.98 ->	4	51	CSS1505	---
Jumpy 1.9 TD	D8B (XUD9TF)	04.96 ->	4	68	CSS1506	---
Jumpy 1.9 TD	DHX (XUD9TF/BTF)	10.95 ->	4	66	CSS1506	---
Jumpy 2.0	RFN (EW10J4)	04.00 - 12.06	4	100	CSS1516	---
Jumpy 2.0 HDi 95	---	07.11 ->	4	72	CSS1539	---
Jumpy 2.0 HDi 95	RHX	10.99 ->	4	69	CSS1516	---
Jumpy 2.0 HDi 110	RHZ (DW10ATED)	03.00 ->	4	80	CSS1516	CSS1510
Jumpy 2.0 HDi 120	RHK (DW10UTED4)	01.07 ->	4	88	---	CSS1510
Jumpy 2.0 HDi 120	RHK (DW10UTED4)	01.07 ->	4	88	CSS1539	---
Jumpy 2.0 HDi 125	---	07.11 ->	4	94	CSS1539	---
Jumpy 2.0 HDi 140	RHR (DW10BTED4)	01.07 ->	4	100	---	CSS1510
Jumpy 2.0 HDi 140	RHR (DW10BTED4)	01.07 ->	4	100	CSS1539	---
Jumpy 2.0 HDi 165	RHH (DW10CTED4)	07.10 ->	4	120	---	CSS1510

Typ Type	Motornummer Engine-No.	Baujahr Year	Zyl. Cyl.	KW	Kurbelwellen- sensor Crankshaft S.	Nocken- wellensensor Camshaft S.
Jumpy 2.0 i	RFH (EW10A)	01.07 ->	4	103	CSS1522	CSS1511
Jumpy 2.0 i	RFN (EW10J4)	04.00 - 12.06	4	100	CSS1513	---
Jumpy 2.0i 16V	---	03.00 ->	4	102	CSS1513	CSS1511
Nemo 1.3 HDi 75	FHZ (F13DTE5)	10.10 ->	4	55	---	CSS716
Nemo 1.4	KFV (TU3A)	02.08 ->	4	54	CSS1518	---
Nemo 1.4	KFV (TU3A)	04.09 ->	4	54	CSS1518	---
Nemo 1.4 HDI	8HS (DV4TD)	02.08 ->	4	50	CSS1538	CSS1519
Saxo 1.0 X	CDZ (TU9M)	05.96 - 11.98	4	33	CSS1507	---
Saxo 1.1 X, SX	HDZ (TU1M)	05.96 - 09.03	4	40	CSS1507	---
Saxo 1.1 X, SX	HDZ (TU1M), HFX (TU1JP)	05.96 - 09.03	4	44	CSS1507	---
Saxo 1.4 VTS	KFW (TU3JP), KFX (TU3JP)	05.96 - 06.03	4	55	CSS1507	CSS1503
Saxo 1.4 VTS	KFX (TU3JP), KFW (TU3JP)	05.96 - 06.03	4	55	CSS1520	---
Saxo 1.5 D	VJY (TUD5)	09.96 - 09.03	4	40	CSS1505	---
Saxo 1.5 D	VJZ (TUD5)	09.96 - 06.01	4	42	CSS1505	---
Saxo 1.6 VTL, VTR	NFZ (TU5JP)	05.96 - 06.03	4	65	CSS1518	---
Saxo 1.6 VTS	NFT	09.00 - 09.03	4	72	CSS1518	---
Saxo 1.6 VTS	NFX (TU5JP4)	06.96 - 09.03	4	87	CSS1502	---
Xantia 1.6i	BFZ (XU5JP)	03.93 - 01.98	4	65	CSS1501	---
Xantia 1.8i	LFX (XU7JB)	01.98 - 04.03	4	66	CSS1506	---
Xantia 1.8i	LFX (XU7JB)	04.97 - 01.98	4	66	CSS1506	---
Xantia 1.8i	LFZ (XU7JP)	03.93 - 01.98	4	74	CSS1506	---
Xantia 1.8i 16V	LFY (XU7JP4)	01.98 - 04.03	4	81	CSS1506	CSS1509
Xantia 1.8i 16V	LFY (XU7JP4)	06.95 - 01.98	4	81	CSS1506	---
Xantia 1.9 D	D9B (XUD9A/L)	06.94 - 01.98	4	51	CSS1504	---
Xantia 1.9 D	DJZ (XUD9Y)	06.94 - 01.98	4	50	CSS1504	---
Xantia 1.9 SD	DHW (XUD9SD)	01.98 - 04.03	4	55	CSS1504	---
Xantia 1.9 SD	DHW (XUD9SD)	02.96 - 01.98	4	55	CSS1504	---
Xantia 1.9 Turbo D	DHX (XUD9TF/BTF), DHY (XUD9TE/Y)	01.98 - 04.03	4	66	CSS1501	---
Xantia 1.9 Turbo D	DHX (XUD9TF/BTF), DHY (XUD9TE/Y)	10.94 - 01.98	4	66	CSS1504	---
Xantia 2.0 HDI 109	RHZ (DW10ATED)	02.99 - 04.03	4	80	CSS1506	---
Xantia 2.0 HDI 90	RHY (DW10TD)	03.99 - 04.03	4	66	CSS1506	CSS1510
Xantia 2.0 Turbo	RGX (XU10J2TE)	01.98 - 04.03	4	108	CSS1500	---
Xantia 2.0 Turbo	RGX (XU10J2TE)	06.95 - 01.98	4	108	CSS1500	---
Xantia 2.0i	RFX (XU10J2C)	01.98 - 04.03	4	89	CSS1500	---
Xantia 2.0i	RFX (XU10J2C)	03.93 - 01.98	4	89	CSS1500	---
Xantia 2.0i 16V	RFT (XU10J4/Z)	06.94 - 01.98	4	110	CSS1500	CSS1503
Xantia 2.0i 16V	RFT (XU10J4/Z)	06.94 - 01.98	4	110	---	---
Xantia 2.0i 16V	RFV (XU10J4R)	01.98 - 04.03	4	97	CSS1500	---
Xantia 2.0i 16V	RFX (XU10J4R)	06.95 - 01.98	4	97	CSS1500	---
Xantia 2.0i 16V	RFY (XU10J4/Z)	03.93 - 01.98	4	112	CSS1500	CSS1503
Xantia 2.1 Turbo D 12V	P8C (XUD11BTE)	01.98 - 02.99	4	80	CSS1500	---
Xantia 2.1 Turbo D 12V	P8C (XUD11BTE)	06.95 - 01.98	4	80	CSS1500	---
Xantia 3.0 V6	XFZ (ES9J4)	01.98 - 04.03	6	140	CSS1501	---
Xantia 3.0i 24V	XFZ (ES9J4)	01.97 - 01.98	6	140	CSS1501	---
XM 2.0 Turbo	RGX (XU10J2TE)	05.94 - 10.00	4	108	CSS1500	---
XM 2.0i	RFZ (XU10J2)	05.89 - 06.94	4	89	CSS1501	---
XM 2.0i 16V	RFV (XU10J4R)	05.94 - 10.00	4	97	CSS1500	---
XM 2.0i Turbo	RGY (XU10J2TE/Z)	09.92 - 06.94	4	104	CSS1501	---
XM 2.1 TD 12V	P8A (XUD11ATE)	05.94 - 10.00	4	80	CSS1500	---
XM 2.5 TD	THY (DK5ATE)	05.94 - 10.00	4	95	CSS1506	---
XM 3.0 V6	SFZ (ZPJ/Z), UFZ (ZPJ/Z)	05.89 - 06.94	6	123	CSS1501	---
XM 3.0 V6	SFZ (ZPJ/Z), UFZ (ZPJ/Z)	05.94 - 10.00	6	123	CSS1501	---
XM 3.0 V6	XFZ (ES9J4)	04.97 - 10.00	6	140	CSS1501	---
XM 3.0 V6 24V	SKZ (ZPJ4/Z), UKZ (ZPJ4/Z)	07.90 - 06.94	6	147	CSS1501	---
XM 3.0 V6 24V	SKZ (ZPJ4/Z), UKZ (ZPJ4/Z)	05.94 - 10.00	6	147	CSS1501	---
Xsara 1.4 HDI	8HX (DV4TD)	01.03 - 03.05	4	50	CSS1517	CSS1519
Xsara 1.4i	KFW (TU3JP), KFX (TU3JP)	04.97 - 03.05	4	55	CSS1507	CSS1503
Xsara 1.4i	KFW (TU3JP), KFX (TU3JP)	04.97 - 03.05	4	55	CSS1518	---

Typ Type	Motornummer Engine-No.	Baujahr Year	Zyl. Cyl.	KW	Kurbelwellen- sensor Crankshaft S.	Nocken- wellensensor Camshaft S.
Xsara 1.5 D	VJZ (TUD5)	04.97 - 09.00	4	42	CSS1505	---
Xsara 1.6 16V	NFU (TU5JP4)	09.00 - 03.05	4	80	CSS1518	---
Xsara 1.6i	NFZ (TU5JP)	04.97 - 09.00	4	65	CSS1518	---
Xsara 1.8 D	161A (XUD7), A9A (XUD7)	04.97 - 09.00	4	43	CSS1504	---
Xsara 1.8i	LFX (XU7JB)	04.97 - 09.00	4	66	CSS1501	---
Xsara 1.8i 16V	LFY (XU7JP4)	04.97 - 09.00	4	81	CSS1501	---
Xsara 1.8i Aut.	LFZ (XU7JP)	04.97 - 09.00	4	74	CSS1501	---
Xsara 1.9 D	DJY (XUD9A)	04.97 - 09.00	4	50	CSS1504	---
Xsara 1.9 D	WJY (DW8B), WJZ (DW8)	07.98 - 03.05	4	51	CSS1506	---
Xsara 1.9 SD	DHV (XUD9BSD)	01.98 - 09.00	4	55	CSS1506	---
Xsara 1.9 TD	DHY (XUD9TE/Y)	04.97 - 09.00	4	66	CSS1504	---
Xsara 2.0 16V	RFN (EW10J4)	09.00 - 03.05	4	100	CSS1513	CSS1511
Xsara 2.0 16V	RFS (XU10J4RS)	04.97 - 09.00	4	120	CSS1500	CSS1503
Xsara 2.0 16V	RFV (XU10J4R)	07.98 - 09.00	4	97	CSS1500	---
Xsara 2.0 HDI 109	RHZ (DW10ATED)	05.01 - 03.05	4	80	CSS1514	---
Xsara 2.0 HDI 90	RHY (DW10TD)	02.99 - 03.05	4	66	CSS1514	CSS1510
Xsara Picasso 1.6	NFZ (TU5JP)	12.99 ->	4	65	CSS1515	---
Xsara Picasso 1.6 16V	NFU (TU5JP4)	09.05 ->	4	80	CSS1515	---
Xsara Picasso 1.6 HDI	9HX (DV6ATED4)	09.05 ->	4	66	CSS1517	CSS1510
Xsara Picasso 1.6 HDI	DV6TED4	05.04 ->	4	80	CSS1517	CSS1510
Xsara Picasso 1.8 16V	6FZ (EW7J4), LFY (XU7JP4)	02.00 ->	4	85	CSS1513	CSS1511
Xsara Picasso 2.0 16V	RFN (EW10J4)	01.03 ->	4	100	CSS1513	CSS1511
Xsara Picasso 2.0 HDI	RHY (DW10TD)	12.99 ->	4	66	CSS1513	CSS1510
ZX 1.1	HDZ (TU1M)	03.91 - 06.97	4	44	CSS1507	---
ZX 1.6i	BDY (XU5M), BFZ (XU5JP)	03.91 - 06.97	4	65	CSS1506	---
ZX 1.8 D	161A (XUD7)	06.93 - 06.97	4	44	CSS1504	---
ZX 1.8i	LFZ (XU7JP)	07.92 - 06.97	4	74	CSS1506	---
ZX 1.8i 16V	LFY (XU7JP4)	01.96 - 06.97	4	81	CSS1501	---
ZX 1.9 D	D9B (XUD9A/U)	06.94 - 06.97	4	50	CSS1504	---
ZX 1.9 D	DJZ (XUD9Y)	03.91 - 06.97	4	47	CSS1504	---
ZX 1.9 TD	DHY (XUD9TE/Y)	07.92 - 06.97	4	66	CSS1504	---
ZX 2.0i	RFX (XU10J2C)	07.92 - 06.97	4	89	CSS1500	---
ZX 2.0i 16V	RFS (XU10J4RS)	05.96 - 06.97	4	120	CSS1501	---
ZX 2.0i 16V	RFS (XU10J4RS)	05.96 - 06.97	4	120	---	CSS1503
ZX 2.0i 16V	RFT (XU10J4/Z)	06.94 - 06.97	4	110	CSS1506	---
ZX 2.0i 16V	RFT (XU10J4/Z)	06.94 - 06.97	4	110	---	CSS1503
ZX 2.0i 16V	RFT (XU10J4/Z), RFY (XU10J4/Z)	07.92 - 10.94	4	112	---	CSS1503
ZX 2.0i 16V	RFT (XU10J4/Z), RFY (XU10J4/Z)	07.92 - 10.94	4	112	CSS1501	---
<b>Dacia</b>						
Dokker 1.2 TCe	H5F 402	11.12 ->	4	85	CSS1544	---
Dokker 1.5 dCi	K9K 612	11.12 ->	4	55	CSS1537	---
Dokker 1.6	K7M 812, K7M 828	11.12 ->	4	61	CSS1543	---
Dokker 1.6 LPG	K7M 812, K7M 828	11.13 ->	4	61	CSS1543	---
Dokker Express 1.2 TCe 115	H5F 402	12.12 ->	4	84	CSS1544	---
Dokker Express 1.5 dCi	K9K 612	12.12 ->	4	55	CSS1537	---
Dokker Express 1.6	K7M 812, K7M 828	12.12 ->	4	61	CSS1543	---
Dokker Express 1.6 LPG	K7M 812, K7M 828	11.13 ->	4	61	CSS1543	---
Duster 1.2 TCe 125	H5F 404	10.13 ->	4	92	CSS1544	---
Duster 1.2 TCe 125 4x4	H5F 410	06.15 ->	4	92	CSS1544	---
Duster 1.5 dCi	K9K 796	04.10 ->	4	63	CSS1537	CSS1540
Duster 1.5 dCi	K9K 796, K9K 830	04.10 ->	4	63	CSS1541	---
Duster 1.5 dCi	K9K 856	08.13 ->	4	80	CSS1537	---
Duster 1.5 dCi	K9K 884, K9K 892	10.10 ->	4	66	CSS1541	---
Duster 1.5 dCi	K9K 892	10.10 ->	4	66	CSS1537	CSS1540
Duster 1.5 dCi	K9K 896	06.10 ->	4	79	CSS1537	CSS1540
Duster 1.5 dCi	K9K 896	06.10 ->	4	79	CSS1541	---
Duster 1.5 dCi 4x4	K9K 858	08.13 ->	4	80	CSS1537	---
Duster 1.6 16V	K4M 690	04.10 ->	4	77	CSS1534	---

Typ Type	Motornummer Engine-No.	Baujahr Year	Zyl. Cyl.	KW	Kurbelwellen- sensor Crankshaft S.	Nocken- wellensensor Camshaft S.
Duster 1.6 16V	K4M 696, K4M 690	04.10 ->	4	77	CSS1542	---
Duster 1.6 16V Hi-Flex	K4M 696	08.10 ->	4	77	CSS1534	---
Duster 1.6 16V LPG	K4M 696	04.11 ->	4	77	CSS1534	---
Duster 1.6 16V LPG	K4M 696	04.11 ->	4	77	CSS1542	---
Duster 1.6 SCe 115	H4M 438, H4M 738	06.15 ->	4	84	CSS1544	---
Duster 1.6 SCe 115 4x4	H4M 430, H4M 730, H4M 738	06.15 ->	4	84	CSS1544	---
Duster 1.6 SCe 115 LPG	H4M 740	06.15 ->	4	84	CSS1544	---
Duster Box 1.2 TCe 125 4x4	H5F 404	10.13 ->	4	92	CSS1544	---
Lodgy 1.2 TCe	H5F 402	03.12 ->	4	85	CSS1544	---
Lodgy 1.6	K7M 812, K7M 828	03.12 ->	4	61	CSS1543	---
Lodgy 1.6 SCe 115	H4M 740	06.15 ->	4	75	CSS1544	---
Logan 1.4	K7J 710	09.04 ->	4	55	CSS1543	---
Logan 1.4 MPI LPG	K7J 714, K7J 710	02.06 ->	4	55	CSS1543	---
Logan 1.5 dCi	K9K 792	01.06 ->	4	50	CSS1541	---
Logan 1.5 dCi	K9K 796	09.07 ->	4	63	CSS1541	---
Logan 1.5 dCi	K9K 892	05.10 ->	4	55	CSS1541	---
Logan 1.5 dCi	K9K 892	05.10 ->	4	65	CSS1541	---
Logan 1.6	K7M 710	09.04 ->	4	64	CSS1543	---
Logan 1.6 16V	K4M 696, K4M 690	02.06 ->	4	77	CSS1542	---
Logan 1.6 16V Flexifuel	K4M 696	07.10 ->	4	77	CSS1534	---
Logan 1.6 16V Flexifuel	K4M 696	07.10 ->	4	77	CSS1542	---
Logan 1.6 Bifuel	K7M 710	11.08 ->	4	64	CSS1543	---
Logan 1.6 MPI 85	K7M 800	05.10 ->	4	62	CSS1543	---
Logan Express 1.4	K7J 710	03.09 ->	4	55	CSS1532	---
Logan Express 1.4	K7J 710	03.09 ->	4	55	CSS1543	---
Logan Express 1.5 dCi	K9K 792	03.09 ->	4	50	CSS1537	---
Logan Express 1.5 dCi	K9K 792	03.09 ->	4	50	CSS1541	---
Logan Express 1.5 dCi	K9K 796	03.09 ->	4	63	CSS1537	---
Logan Express 1.5 dCi	K9K 796	03.09 ->	4	63	CSS1541	---
Logan Express 1.5 dCi	K9K 892	05.10 ->	4	55	CSS1537	---
Logan Express 1.5 dCi	K9K 892	05.10 ->	4	55	CSS1541	---
Logan Express 1.5 dCi	K9K 892	05.10 ->	4	65	CSS1537	---
Logan Express 1.5 dCi	K9K 892	05.10 ->	4	65	CSS1541	---
Logan Express 1.6	K7M 710	03.09 ->	4	64	CSS1532	---
Logan Express 1.6	K7M 710	03.09 ->	4	64	CSS1543	---
Logan Express 1.6 MPI 85	K7M 800	05.10 ->	4	62	CSS1543	---
Logan I 1.4	K7J 710	09.04 ->	4	55	CSS1532	---
Logan I 1.5 dCi	K9K 790	09.05 ->	4	48	CSS1536	CSS1540
Logan I 1.5 dCi	K9K 792	01.06 ->	4	50	CSS1536	CSS1540
Logan I 1.5 dCi	K9K 796	09.07 ->	4	63	CSS1536	CSS1540
Logan I 1.5 dCi	K9K 892	05.10 ->	4	55	CSS1536	CSS1540
Logan I 1.5 dCi	K9K 892	05.10 ->	4	65	CSS1536	CSS1540
Logan I 1.6	K7M 710	09.04 ->	4	64	CSS1532	---
Logan I 1.6 16V	K4M 690, K4M 696	02.06 ->	4	77	CSS1534	---
Logan II 1.2	---	10.12 ->	4	55	CSS1532	---
Logan II 1.2 LPG	D4F 734	10.12 ->	4	55	CSS1532	---
Logan II 1.5 dCi	K9K 612	10.12 ->	4	66	CSS1537	---
Logan II Tce 90	H4B 400	10.12 ->	3	66	CSS1542	---
Logan II TCe 90	H4B 400, H4B 408	10.12 ->	3	66	CSS1544	---
Logan MCV I 1.4	K7J 710	02.07 ->	4	55	CSS1543	---
Logan MCV I 1.4	K7J 710	02.07 ->	4	55	CSS1532	---
Logan MCV I 1.5 dCi	K9K 792	02.07 ->	4	50	CSS1541	---
Logan MCV I 1.5 dCi	K9K 792	02.07 ->	4	50	CSS1536	---
Logan MCV I 1.5 dCi	K9K 796	09.07 ->	4	63	CSS1541	---
Logan MCV I 1.5 dCi	K9K 796	09.07 ->	4	63	CSS1536	---
Logan MCV I 1.5 dCi	K9K 796	09.07 ->	4	63	CSS1537	---
Logan MCV I 1.5 dCi	K9K 892	05.10 ->	4	55	CSS1541	---
Logan MCV I 1.5 dCi	K9K 892	05.10 ->	4	65	CSS1541	---
Logan MCV I 1.5 dCi	K9K 892	05.10 ->	4	55	CSS1536	---

Typ Type	Motornummer Engine-No.	Baujahr Year	Zyl. Cyl.	KW	Kurbelwellen- sensor Crankshaft S.	Nocken- wellensensor Camshaft S.
Logan MCV I 1.5 dCi	K9K 892	05.10 ->	4	65	CSS1536	---
Logan MCV I 1.6	K7M 710	02.07 ->	4	64	CSS1543	---
Logan MCV I 1.6	K7M 710	02.07 ->	4	64	CSS1532	---
Logan MCV I 1.6 16V	K4M 690, K4M 696	02.07 ->	4	77	CSS1534	---
Logan MCV I 1.6 16V	K4M 696, K4M 690	02.07 ->	4	77	CSS1542	---
Logan MCV I 1.6 16V Hi-Flex	K4M 690	11.09 ->	4	77	CSS1542	---
Logan MCV I 1.6 Bifuel	K7M 710	11.08 ->	4	64	CSS1532	---
Logan MCV I 1.6 MPI 85	K7M 800	05.10 ->	4	62	CSS1543	---
Logan MCV II 1.2	---	02.13 ->	4	55	CSS1532	---
Logan MCV II 1.2 LPG	---	02.13 ->	4	55	CSS1532	---
Logan MCV II 1.5 dCi	K9K 612	02.13 ->	4	55	CSS1537	---
Logan MCV II 1.5 dCi	K9K 612	02.13 ->	4	66	CSS1537	---
Logan MCV II TCe 90	H4B 400, H4B 408	02.13 ->	3	66	CSS1544	---
Logan Pick-up 1.4	K7J 710	01.09 ->	4	55	CSS1543	---
Logan Pick-up 1.5 dCi	K9K 792	03.08 ->	4	50	CSS1537	---
Logan Pick-up 1.5 dCi	K9K 792	03.08 ->	4	50	CSS1541	---
Logan Pick-up 1.5 dCi	K9K 796	03.08 ->	4	63	CSS1537	---
Logan Pick-up 1.5 dCi	K9K 796	03.08 ->	4	63	CSS1541	---
Logan Pick-up 1.5 dCi	K9K 892	05.10 ->	4	55	CSS1537	---
Logan Pick-up 1.5 dCi	K9K 892	05.10 ->	4	55	CSS1541	---
Logan Pick-up 1.5 dCi	K9K 892	05.10 ->	4	65	CSS1537	---
Logan Pick-up 1.5 dCi	K9K 892	05.10 ->	4	65	CSS1541	---
Logan Pick-up 1.6	K7M 710	03.08 ->	4	64	CSS1532	---
Logan Pick-up 1.6	K7M 710	03.08 ->	4	64	CSS1543	---
Logan Pick-up 1.6 MPI 85	K7M 800	05.10 ->	4	62	CSS1543	---
Sandero I 1.2 16V	D4F 732	11.08 ->	4	55	CSS1532	---
Sandero I 1.4	K7J 710	06.08 ->	4	55	CSS1543	---
Sandero I 1.4	K7J 710	06.08 ->	4	55	CSS1532	---
Sandero I 1.4	K7M 800	05.10 ->	4	62	CSS1543	---
Sandero I 1.5 dCi	K9K 792	11.08 ->	4	50	CSS1541	---
Sandero I 1.5 dCi	K9K 792	11.08 ->	4	50	CSS1536	---
Sandero I 1.5 dCi	K9K 796	11.08 ->	4	63	CSS1541	---
Sandero I 1.5 dCi	K9K 796	11.08 ->	4	63	CSS1536	CSS1540
Sandero I 1.5 dCi	K9K 796	11.08 ->	4	50	CSS1537	---
Sandero I 1.5 dCi	K9K 796	11.08 ->	4	63	CSS1537	---
Sandero I 1.5 dCi	K9K 892	05.10 ->	4	55	CSS1541	---
Sandero I 1.5 dCi	K9K 892	05.10 ->	4	65	CSS1541	---
Sandero I 1.5 dCi	K9K 892	05.10 ->	4	55	CSS1536	CSS1540
Sandero I 1.5 dCi	K9K 892	05.10 ->	4	65	CSS1536	CSS1540
Sandero I 1.6	K7M 710	06.08 ->	4	64	CSS1532	---
Sandero I 1.6 16V	K4M 690	07.11 ->	4	77	CSS1542	---
Sandero I 1.6 16V	K4M 690	07.11 ->	4	77	CSS1534	---
Sandero I 1.6 16V Bifuel	K4M 696, K4M 694, K4M 690	01.11 ->	4	77	CSS1542	---
Sandero I 1.6 16V Bifuel	K4M 696, K4M 694, K4M 690	01.11 ->	4	77	CSS1534	---
Sandero I 1.6 MPI 85	K7M 710	06.08 ->	4	64	CSS1543	---
Sandero II 1.2	D4F 732	01.13 ->	4	55	CSS1532	---
Sandero II 1.2 LPG	---	01.13 ->	4	55	CSS1532	---
Sandero II 1.5 dCi	K9K 612	01.13 ->	4	55	CSS1537	---
Sandero II 1.5 dCi	K9K 612	01.13 ->	4	66	CSS1537	---
Sandero II TCe 90	H4B 400	10.12 ->	3	66	CSS1544	---
<b>Daewoo</b>						
Kalos 1.4	F14S3	09.02 ->	4	61	CSS1402	---
Kalos 1.4 16V	F14D3	04.03 ->	4	69	CSS1401	---
Kalos Saloon	F14S3	11.02 - 12.04	4	61	CSS1402	---
Matiz 0.8	F8CV	09.98 ->	3	38	CSS1401	---
Matiz 1.4	B10S	01.03 ->	4	47	CSS1402	---
Tico 0.8	F8CV	01.96 - 12.00	3	38	CSS1401	---

Typ Type	Motornummer Engine-No.	Baujahr Year	Zyl. Cyl.	KW	Kurbelwellen- sensor Crankshaft S.	Nocken- wellensensor Camshaft S.
<b>Fiat</b>						
500 0.9	312 A2.000	07.10 ->	2	63	CSS1321	---
500 1.2	169 A4.000	10.07 ->	4	51	CSS1318	---
500 1.2 LPG	169 A4.000	12.10 ->	4	51	CSS1321	---
500 1.3 D Multijet	169 A1.000	12.09 ->	4	55	CSS1303	CSS716
500 1.3 D Multijet	199 B1.000	12.09 ->	4	70	CSS1303	CSS716
500 C 0.9	312 A2.000	09.09 ->	4	63	CSS1321	---
500 C 1.2	169 A4.000	09.09 ->	4	51	CSS1318	---
500 C 1.3 D Multijet	169 A1.000	09.09 ->	4	55	CSS1303	CSS716
500 C 1.3 D Multijet	199 B1.000	09.09 ->	4	70	CSS1303	CSS716
500 L 0.9 Natural Power	312 A2.000	03.13 ->	2	63	CSS1321	---
500 L 1.3 D Multijet	199 B4.000	09.12 ->	4	62	CSS1303	CSS716
500L 1.3 D Multijet	330 A1.000	06.14 ->	4	70	---	CSS716
Argenta 2000	132 C2.000, 132 D1.000	06.78 - 12.85	4	83	CSS1306	---
Argenta 2000 i.e.	132 C3.000	06.81 - 07.86	4	90	CSS1306	---
Brava 1.4	182 A5.000	10.95 - 10.01	4	55	---	CSS1307
Brava 1.4 12 V	182 A3.000	10.95 - 08.98	4	59	---	CSS1307
Brava 1.6 16V	182 A4.000	02.96 - 10.01	4	76	CSS1304	---
Brava 1.6 16V	182 A4.000	02.96 - 10.01	4	76	---	CSS1308
Brava 1.6 16V	182 A6.000	10.95 - 10.01	4	66	CSS1304	---
Brava 1.6 16V	182 A6.000	10.95 - 10.01	4	66	---	CSS1308
Brava 1.9 TD 100 S	182 A7.000	03.96 - 10.01	4	74	---	CSS1307
Brava 1.9 TD 75 S	182 A8.000	03.96 - 10.01	4	55	---	CSS1307
Bravo I 1.4	182 A3.000	10.95 - 10.01	4	59	---	CSS1307
Bravo I 1.4	182 A5.000	10.95 - 10.01	4	55	---	CSS1307
Bravo I 1.6 16V	182 A4.000	03.96 - 10.01	4	76	CSS1304	CSS1308
Bravo I 1.6 16V	182 A6.000	10.95 - 10.01	4	66	---	CSS1308
Bravo I 1.9 TD 100 S	182 A7.000	03.96 - 10.01	4	74	---	CSS1307
Bravo I 1.9 TD 75 S	182 A8.000	03.96 - 10.01	4	55	---	CSS1307
Bravo I 2.0 HGT 20V	182 A1.000	10.95 - 07.98	5	108	---	CSS1307
Bravo II 1.6 D Multijet	198 A2.000	03.08 ->	4	88	CSS1300	CSS1322
Bravo II 1.6 D Multijet	198 A3.000	03.08 ->	4	77	CSS1300	CSS1322
Bravo II 1.6 D Multijet	198 A6.000	03.08 ->	4	66	CSS1300	CSS1322
Bravo II 1.9 D Multijet	192 A8.000	04.07 ->	4	88	CSS1317	---
Bravo II 1.9 D Multijet	192 B5.000	04.07 - 12.08	4	66	CSS1317	---
Bravo II 1.9 D Multijet	937 A5.000	04.07 ->	4	110	CSS1300	CSS1301
Bravo II 2.0 D Multijet	198 A5.000, 844 A2.000	09.08 ->	4	121	CSS1300	CSS1301
Cinquecento 0.7 i	170 A.046	07.94 - 01.98	2	22	CSS1306	---
Coupe 2.0 20V	182 A1.000	08.96 - 04.98	5	108	---	CSS1307
Coupe 2.0 20V Turbo	175 A3.000	08.96 - 08.00	5	162	---	CSS1307
Croma 1.9 D Multijet	939 A1.000	06.05 ->	4	88	CSS1317	---
Croma 1.9 D Multijet	939 A2000	06.05 ->	4	110	---	CSS1301
Croma 1600	154 A.048	12.85 - 12.90	4	61	CSS1306	---
Croma 2.4 D Multijet	939 A3.000	06.05 ->	5	147	CSS1300	CSS1301
Croma 2000 CHT	154 A1.000	12.85 - 02.89	4	66	CSS1306	---
Croma 2000 i.e.	154 C3.000, 834 B.000	03.87 - 09.92	4	88	CSS1306	---
Croma 2000 i.e.	154 C3.000, 834 B.146	10.87 - 08.96	4	85	CSS1306	---
Croma 2000 i.e.	834 B.048	03.86 - 09.90	4	83	CSS1306	---
Croma 2000 i.e. Turbo	154 A2.000	12.85 - 06.90	4	114	CSS1306	---
Croma 2000 i.e. Turbo	154 C4.046, 834C.146	06.87 - 08.96	4	110	CSS1306	---
Croma 2000 i.e. Turbo	834 C.146	11.86 - 11.88	4	111	CSS1306	---
Doblo 1.2	223 A5.000	03.01 ->	4	48	---	CSS914
Doblo 1.3 D Multijet	223 A9.000	10.05 ->	4	62	---	CSS716
Doblo 1.3 D Multijet	263 A2.000, 199 A3.000	02.10 ->	4	66	CSS1303	CSS716
Doblo 1.4	350 A1.000	10.05 ->	4	57	CSS1318	---
Doblo 1.6 16V	182 B6.000	10.01 ->	4	76	CSS1304	---
Doblo 1.6 16V	182 B6.000	10.01 ->	4	76	---	CSS1308
Doblo 1.6 D 16V Multijet	263 A4.000	02.10 ->	4	66	---	CSS1322
Doblo 1.6 Natural Power	182 B6.000	09.02 ->	4	76	---	CSS914

Typ Type	Motornummer Engine-No.	Baujahr Year	Zyl. Cyl.	KW	Kurbelwellen- sensor Crankshaft S.	Nocken- wellensensor Camshaft S.
Doblo 1.9 D Multijet	186 A9.000	10.05 ->	4	88	CSS1317	---
Doblo Cargo 1.2	223 A5.000	03.01 ->	4	48	---	CSS914
Doblo Cargo 1.3 D Multijet	199 A2.000	10.05 - 01.10	4	55	CSS1303	CSS716
Doblo Cargo 1.3 JTD 16V	188 A9.000	05.04 - 12.06	4	51	CSS1303	---
Doblo Cargo 1.3 JTD 16V Multijet	223 A9.000	08.06 ->	4	62	CSS1303	---
Doblo Cargo 1.4	350 A1.000	10.05 ->	4	57	CSS1318	---
Doblo Cargo 1.6 16V	182 B6.000	10.01 ->	4	76	CSS1304	CSS1308
Doblo Cargo 1.6 D Multijet	198 A3.000	02.10 ->	4	77	CSS1300	CSS1322
Doblo Cargo 1.6 D Multijet	263 A3.000	02.10 ->	4	74	---	CSS1322
Doblo Cargo 1.6 D Multijet	263 A4.000	02.10 ->	4	66	---	CSS1322
Doblo Cargo 1.9 JTD	223 A7.000, 223 B1.000	07.03 ->	4	77	CSS1317	---
Doblo Cargo 2.0 D Multijet	263 A1.000	02.10 ->	4	99	CSS1300	---
Ducato 1.9 TD	DHX (XUD9TF/L)	04.98 - 04.02	4	66	CSS1500	---
Ducato 2.0	RFL	04.02 ->	4	81	CSS1513	---
Ducato 2.0 Bipower	RFL	11.02 ->	4	81	CSS1513	---
Ducato 2.0 D Multijet 115	250 A1.000	06.11 ->	4	85	CSS1300	---
Ducato 2.0 JTD	RHV (DW10)	10.01 - 04.02	4	62	CSS1513	---
Ducato 2.0 JTD	RHV (DW10)	04.02 ->	4	62	CSS1513	---
Ducato 2.0 JTD	RHV (DW10)	10.01 - 04.02	4	62	CSS1513	---
Ducato 2.0 Panorama/Combinato	RFW	03.94 - 04.02	4	80	CSS1501	---
Fiorino 1.3 D Multijet	199 B1.000	07.09 ->	4	70	CSS1303	CSS716
Fiorino 1.4	KFT, KFV	02.08 ->	4	54	CSS1518	---
Fiorino 75 i.e. 1.5	149 C1.000	05.88 - 12.93	4	55	CSS1306	---
Freemont 2.0 JTD	939 B5.000	08.11 ->	4	125	CSS1300	---
Freemont 2.0 JTD	939 B5.000, 940 A5.000	08.11 ->	4	103	CSS1300	---
Grande Punto 1.2	199 A4.000	10.05 ->	4	48	CSS1318	---
Grande Punto 1.3 D Multijet	199 A2.000	10.05 ->	4	55	CSS1303	---
Grande Punto 1.3 D Multijet	199 A3.000	10.05 ->	4	66	CSS1303	---
Grande Punto 1.4	350 A1.000	10.05 ->	4	57	CSS1318	---
Grande Punto 1.9 D Multijet	199 A5.000	10.05 ->	4	96	CSS1317	---
Grande Punto 1.9 D Multijet	939 A1.000	10.05 ->	4	88	CSS1317	---
Idea 1.3 D Multijet	199 B1.000	05.08 ->	4	70	CSS1303	CSS716
Idea 1.3 JTD	188 A9.000	01.04 ->	4	51	CSS1303	---
Idea 1.3 Multijet	199 A3.000	10.05 ->	4	66	---	CSS716
Idea 1.4	350 A1.000	10.05 ->	4	57	CSS1318	---
Idea 1.9 JTD	188 B2.000	01.04 ->	4	74	CSS1317	---
Linea 1.3 D Multijet	199 A3.000	06.07 ->	4	66	CSS1303	CSS716
Linea 1.4	350 A1.000	06.07 ->	4	57	CSS1318	---
Linea 1.6 Multijet	198 A3.000	06.09 ->	4	77	CSS1300	CSS1322
Marea 1.6 100 16V	182 A4.000	09.96 - 05.02	4	76	CSS1304	CSS1308
Marea 1.9 TD 100	182 A7.000	09.96 - 05.02	4	74	---	CSS1307
Marea 1.9 TD 75	182 A8.000	09.96 - 05.02	4	55	---	CSS1307
Marea 2.0 150 20V	182 A1.000	09.96 - 04.99	5	108	---	CSS1307
Marea 2.4 TD 125	185 A2.000	09.96 - 04.99	5	91	---	CSS1307
Marea Bipower 100 1.6 16V	185 A3.000, 186 A4.000	04.99 - 05.02	4	76	CSS1304	CSS1308
Marea Weekend 1.4 80 12V	182 A3.000	09.96 - 05.02	4	59	---	CSS1307
Marea Weekend 1.6 100 16V	182 A4.000	09.96 - 05.02	4	76	CSS1304	CSS1308
Marea Weekend 1.9 TD 100	182 A7.000, 182 B9.000	09.96 - 05.02	4	74	---	CSS1307
Marea Weekend 1.9 TD 75	182 A8.000	09.96 - 05.02	4	55	---	CSS1307
Marea Weekend 2.0 150 20V	182 A1.000	09.96 - 04.99	5	108	---	CSS1307
Marea Weekend 2.4 TD 125	185 A2.000	09.96 - 04.99	5	91	---	CSS1307
Multipla 1.9 JTD	186 A9.000	04.02 - 06.10	4	88	CSS1317	---
Multipla 1.9 JTD 115	186 A8.000	07.02 - 06.10	4	85	CSS1317	---
Multipla 100 1.6 16V	182 A4.000	04.99 - 06.10	4	76	CSS1304	---
Multipla Bipower 1.6 16V	182 B6.000	10.01 - 06.10	4	76	CSS1304	---
Multipla Bipower 1.6 16V	186 A4.000	04.99 - 06.10	4	76	CSS1304	CSS1308
Multipla Blupower 1.6 16V	186 A3.000	04.99 - 06.10	4	70	CSS1304	CSS1308
Palio Weekend 1.2	178 B5.000	04.96 - 02.01	4	54	CSS1305	---
Palio Weekend 1.6 16V	178 B3.000	04.96 - 02.01	4	74	CSS1304	CSS1308

Typ Type	Motornummer Engine-No.	Baujahr Year	Zyl. Cyl.	KW	Kurbelwellen- sensor Crankshaft S.	Nocken- wellensensor Camshaft S.
Palio Weekend 1.6 16V	182 B6.000	02.01 ->	4	76	CSS1304	---
Panda 0.9	312 A2.000	02.12 ->	2	57	CSS1321	---
Panda 0.9	312 A2.000	02.12 ->	2	63	CSS1321	---
Panda 0.9 Natural Power	312 A2.000	07.12 ->	2	63	CSS1321	---
Panda 1.1	187 A1.000	09.03 ->	4	40	CSS1318	---
Panda 1.2	169 A4.000	02.12 ->	4	51	CSS1318	---
Panda 1.2	169 A4.000	03.10 ->	4	51	CSS1318	---
Panda 1.2	188 A4.000	09.03 ->	4	44	CSS1318	---
Panda 1.2 Bi-Power / Natural Power	188 A4.000	01.07 - 11.09	4	44	CSS1321	---
Panda 1.2 LPG	169 A4.000	06.12 ->	4	51	CSS1321	---
Panda 1.2 LPG	169 A4.000	11.10 ->	4	51	CSS1321	---
Panda 1.2 LPG	169 A4.000	06.12 ->	4	51	CSS1318	---
Panda 1.2 LPG	188 A4.000	04.09 ->	4	44	CSS1321	---
Panda 1.3 D Multijet	169 A1.000	06.06 ->	4	55	CSS1303	CSS716
Panda 1.3 D Multijet	199 A9.000	02.12 ->	4	55	CSS1303	CSS716
Panda 1.3 JTD	188 A9.000	09.03 ->	4	51	CSS1303	---
Panda 1.4 Bi-Power / Natural Power	350 A1.000	09.10 ->	4	57	CSS1318	---
Panda Van 1.4 Natural Power	350 A1.000	10.09 ->	4	57	CSS1318	---
Punto / Grande Punto 1.3 D Multijet	199 B2.000	07.08 ->	4	51	CSS1303	---
Punto / Grande Punto 1.3 D Multijet	223 A9.000, 199 B4.000	04.10 ->	4	62	CSS1303	---
Punto 0.9 Bifuel	312 A2.000	03.12 ->	2	63	CSS1321	---
Punto 0.9 Twinair Turbo	312 A2.000	03.12 ->	2	63	CSS1321	---
Punto 1.1	176 A6.000, 176 B2.000	09.93 - 09.99	4	40	CSS1305	---
Punto 1.2	169 A4.000	03.12 ->	4	51	CSS1321	---
Punto 1.2	169 A4.000	03.12 ->	4	51	CSS1318	---
Punto 1.2	176 A8.000	01.94 - 09.99	4	54	CSS1305	---
Punto 1.2	176 B1.000, 176 B4.000	03.94 - 09.99	4	44	CSS1305	---
Punto 1.2	199 B9.000	02.14 ->	4	49	CSS1318	---
Punto 1.2 Natural Power	188 A4.000	09.03 ->	4	44	CSS1318	CSS914
Punto 1.3 D Multijet	199 A2.000, 199 A9.000	03.12 ->	4	55	CSS1303	CSS716
Punto 1.3 D Multijet	199 B1.000	03.12 ->	4	70	CSS1303	CSS716
Punto 1.3 D Multijet	199 B4.000	03.12 ->	4	62	CSS1303	CSS716
Punto 1.3 D Multijet	199 B8.000	12.13 ->	4	59	---	CSS716
Punto 1.3 JTD	188 A9.000	06.03 ->	4	51	---	CSS716
Punto 1.3 JTD 16V	188 A9.000	06.03 ->	4	51	CSS1303	---
Punto 1.4	199 A7.000	03.12 ->	4	55	CSS1318	---
Punto 1.4	350 A1.000	03.12 ->	4	57	CSS1318	---
Punto 1.4 Bifuel	350 A1.000	03.12 ->	4	57	CSS1318	---
Punto 1.4 Natural Power	350 A1.000	03.12 ->	4	57	CSS1318	---
Punto 1.9 JTD	188 A7.000	10.01 ->	4	63	CSS1317	---
Punto 1.9 JTD	188 B2.000	06.03 ->	4	74	CSS1317	---
Punto 60 1.2	188 A4.000	09.99 ->	4	44	CSS1318	CSS914
Punto 85 1.2 16V	176 B9.000	04.97 - 09.99	4	63	CSS1305	---
Punto Cabriolet 60 1.2	176 B1.000, 176 B4.000	05.95 - 06.00	4	44	CSS1305	---
Punto Cabriolet 85 1.2 16V	176 B9.000	04.97 - 06.00	4	63	CSS1305	---
Punto Evo 1.2	169 A4.000	10.09 - 02.12	4	51	CSS1318	---
Punto Evo 1.2	199 A4.000	10.09 - 02.12	4	48	CSS1321	---
Punto Evo 1.3 D Multijet	199 A2.000, 199 A9.000	10.09 - 02.12	4	55	CSS1303	CSS716
Punto Evo 1.3 D Multijet	199 A3.000	10.09 - 02.12	4	66	CSS1303	CSS716
Punto Evo 1.3 D Multijet	199 B1.000	10.09 - 02.12	4	70	CSS1303	CSS716
Punto Evo 1.3 D Multijet	199 B2.000	07.08 - 02.12	4	51	CSS1303	---
Punto Evo 1.3 D Multijet	223 A9.000, 199 B4.000	10.09 - 02.12	4	62	CSS1303	CSS716
Punto Evo 1.4	350 A1.000	10.09 - 02.12	4	57	CSS1318	---
Punto Evo 1.4 LPG	350 A1.000	06.09 - 02.12	4	57	CSS1318	---
Punto Evo 1.4 Natural Power	350 A1.000	10.09 - 02.12	4	57	CSS1318	---
Punto Evo 1.6 D Multijet	955 A3.000	10.09 - 02.12	4	88	CSS1300	CSS1322
Punto Natural Power 1.2	188 A4.000	09.03 ->	4	44	CSS1305	---
Punto Van 1.1	176 B2.000	04.96 - 02.00	4	40	CSS1305	---
Punto Van 60 1.2	188 A4.000	02.00 - 10.09	4	44	CSS1305	---

Typ Type	Motornummer Engine-No.	Baujahr Year	Zyl. Cyl.	KW	Kurbelwellen- sensor Crankshaft S.	Nocken- wellensensor Camshaft S.
Qubo 1.3 D Multijet	199 A2.000	02.08 ->	4	55	CSS1303	---
Qubo 1.3 D Multijet	199 B1.000	07.10 ->	4	70	CSS1303	CSS716
Qubo 1.4	KFT, KFV	09.08 ->	4	54	CSS1518	---
Qubo 1.4 Natural Power	350 A1.000	10.09 ->	4	57	CSS1318	---
Regata 70 1.3	149 A3.000, 149 A7.000	09.83 - 07.89	4	48	CSS1306	---
Regata 75 1.5	138 B3.048, 138 C3.048	12.83 - 12.87	4	55	CSS1306	---
Regata 85 1.5	149 A5.000	05.85 - 12.87	4	58	CSS1306	---
Regata 85 1.6	149 A.000	10.83 - 06.90	4	60	CSS1306	---
Regata Super 100 1.6	149 A2.000, 149 A4.000	10.83 - 12.90	4	74	CSS1306	---
Regata Super 85 1.5	138 B3.000	09.83 - 04.85	4	60	CSS1306	---
Regata Weekend 100 1.6	149 A4.000	09.84 - 12.86	4	74	CSS1306	---
Regata Weekend 75 1.5	138 B3.048, 138 C3.048	09.84 - 07.89	4	55	CSS1306	---
Rimto I 85 1.5	138 A4.000	01.81 - 09.82	4	63	CSS1306	---
Rimto I 75 i.e. 1.5	138 C2.048, 149 C1.000	10.85 - 05.87	4	55	CSS1306	---
Rimto I Sport 105 1.6	138 AR.000	05.81 - 12.82	4	77	CSS1306	---
Rimto I TC Abarth 125 2.0	138 AR1.000	11.81 - 09.82	4	92	CSS1306	---
Rimto II 105 1.6	138 AR.000	01.83 - 12.87	4	77	CSS1306	---
Rimto II 60 1.1	138 B.000, 138 B1.000	10.82 - 10.85	4	40	CSS1306	---
Rimto II 60 1.1	146 A4.048	04.85 - 12.87	4	43	CSS1306	---
Rimto II 85 1.5	138 B3.000	01.83 - 12.87	4	60	CSS1306	---
Rimto II 85 1.5	149 A5.000	08.85 - 05.87	4	58	CSS1306	---
Rimto II TC Abarth 130 2.0	138 AR2.000	04.83 - 12.87	4	96	CSS1306	---
Scudo 1.6 D Multijet	9HU	01.07 ->	4	66	CSS1517	CSS1322
Scudo 1.6 D Multijet	9H07 (DV6UC), 9HM (DV6UC)	02.11 ->	4	66	CSS1547	---
Scudo 1.9 TD	DHX (XUD9TF/L)	02.96 - 12.06	4	66	CSS1506	---
Scudo 2.0	RFN	05.00 - 12.06	4	100	CSS1516	---
Scudo 2.0 D Multijet	RH02	05.11 ->	4	94	CSS1539	---
Scudo 2.0 D Multijet	RHR	01.07 ->	4	100	CSS1539	---
Scudo 2.0 D Multijet	RHR	01.07 ->	4	100	CSS1539	---
Scudo 2.0 JTD	RHX	12.99 - 12.06	4	69	CSS1516	---
Scudo Combinato 1.9 TD Eco	DHX (XUD9TF/L)	02.96 - 12.06	4	66	CSS1506	---
Scudo Combinato 2.0 16V	RFN (EW10J4)	06.00 - 12.06	4	100	CSS1513	---
Scudo Combinato 2.0 JTD	RHZ	12.99 - 12.06	4	80	CSS1516	---
Sedici 1.9 D Multijet	D19AA	06.06 ->	4	88	CSS1317	---
Sedici 2.0 D Multijet	D 20 AA	06.06 ->	4	99	CSS1300	---
Seicento 1.1	187 A1.000, 176 B2.000	01.98 - 01.10	4	40	---	CSS914
Stilo 1.6 16V	182 B6.000	10.01 - 11.06	4	76	CSS1304	CSS1308
Stilo 1.9 D Multijet	937 A5000	09.05 - 11.06	4	110	CSS1300	CSS1301
Stilo 1.9 JTD	192 A5000	01.04 - 11.06	4	103	CSS1300	CSS1301
Stilo 1.9 JTD	192 A1.000, 937 A7.000	10.01 - 11.06	4	85	CSS1317	---
Stilo Multi Wagon 1.6 16V	182 A6.000	01.03 - 08.08	4	76	CSS1304	CSS1308
Stilo Multiwagon 1.9 JTD	192 A5000	01.04 - 11.06	4	103	CSS1300	CSS1301
Strada 1.3 D Multijet	199 B1.000	10.10 ->	4	70	CSS1303	CSS716
Strada 1.3 D Multijet	223 A9.000	05.06 ->	4	62	CSS1303	CSS716
Strada 1.9 JTD	188 A2.000	04.03 ->	4	59	CSS1317	---
Ulysse 1.8	LFW	05.97 - 08.02	4	73	CSS1506	---
Ulysse 1.9 TD	DHX (XUD9TF/L)	02.95 - 08.02	4	66	CSS1506	---
Ulysse 2.0	RFN (EW10J4)	08.02 - 06.11	4	100	CSS1516	---
Ulysse 2.0	RFN (EW10J4)	08.02 - 06.11	4	100	CSS1522	---
Ulysse 2.0	RFU (XU10J2C)	06.94 - 08.02	4	89	CSS1506	---
Ulysse 2.0 16V	RFN	05.98 - 09.00	4	97	CSS1500	---
Ulysse 2.0 16V	RFN	09.00 - 08.02	4	100	CSS1500	---
Ulysse 2.0 16V	RFN (EW10J4)	09.00 - 08.02	4	100	CSS1513	---
Ulysse 2.0 16V	RFN (EW10J4)	09.00 - 08.02	4	100	CSS1522	---
Ulysse 2.0 16V	RFV	05.98 - 09.00	4	97	CSS1506	---
Ulysse 2.0 D Multijet	RHK	05.06 - 06.11	4	88	CSS1539	---
Ulysse 2.0 JTD	RHM (DW10ATED4)	05.03 - 08.06	4	79	CSS1516	---
Ulysse 2.0 JTD	RHW (DW10ATED4)	08.02 - 08.06	4	80	CSS1516	---
Ulysse 2.0 JTD	RHZ	10.99 - 08.02	4	80	CSS1516	---

Typ Type	Motornummer Engine-No.	Baujahr Year	Zyl. Cyl.	KW	Kurbelwellen- sensor Crankshaft S.	Nocken- wellensensor Camshaft S.
Ulysse 2.0 Turbo	RGX (XU10J2CTE)	06.94 - 08.02	4	108	CSS1506	---
Ulysse 2.1 TD	P8C	03.96 - 10.99	4	80	CSS1506	---
Ulysse 2.2 D Multijet	4HS, 4HT (DW12BTED4)	03.08 - 06.11	4	125	CSS1517	---
Ulysse 2.2 JTD	4HW (DW12ATED4)	08.02 - 08.06	4	94	CSS1516	---
Ulysse 3.0	XFW	08.02 - 06.11	6	150	CSS1522	---
Ulysse 3.0 V6	XFW	08.02 - 06.11	6	150	CSS1522	---
Uno 1.3 Turbo i.e.	146 A2.000	04.85 - 08.89	4	77	CSS1306	---
Uno 1.3 Turbo i.e.	146 A2.146	01.87 - 12.87	4	73	CSS1306	---
Uno 1.3 Turbo i.e.	146 A2.246	09.89 - 03.91	4	74	CSS1306	---
Uno 1.4 Turbo i.e.	146 A8.046	09.89 - 09.93	4	82	CSS1306	---
Uno 45 0.9	146 A.000, 146 A.1000	03.83 - 09.92	4	33	CSS1306	---
Uno 75 i.e. 1.5	138 C2.048, 149 C1.000	10.85 - 12.93	4	55	CSS1306	---

## Ford

B-Max 1.4	SPJD	10.12 ->	4	66	---	CSS1801
B-Max 1.4 LPG	RTJC	08.13 ->	4	63	---	CSS1801
B-Max 1.4 LPG	RTJC	08.13 ->	4	66	---	CSS1801
B-Max 1.6 Ti	IQJA	10.12 ->	4	77	---	CSS720
B-Max Van 1.6 Ti	IQJA	10.12 ->	4	77	---	CSS720
C-Max 1.6	SHDA, HWDB, SHDB, HWDA	02.07 ->	4	74	CSS1800	---
C-Max 1.6 TDCi	G8DA, G8DB, G8DD	02.07 ->	4	80	CSS1800	---
C-Max 1.6 TDCi	HHDA, HHDB, GPDA	02.07 ->	4	66	CSS1800	---
C-Max 1.8	QQDA, QQDB	02.07 ->	4	92	CSS1800	---
C-Max 1.8 Flexifuel	Q7DA	02.07 ->	4	92	CSS1800	---
C-Max 1.8 TDCi	KKDA	02.07 ->	4	85	CSS1800	---
C-Max 2.0	AODA, AODB, SYDA, AODE	02.07 ->	4	107	CSS1800	---
C-Max 2.0 TDCi	G6DD, G6DB, G6DG, G6DA	02.07 ->	4	100	CSS1800	---
C-Max I 1.6	HWDA, HWDB, SHDA, SHDB	02.07 - 09.10	4	74	---	CSS1803
C-Max I 1.6	HWDA, HWDB, SHDA, SHDB	12.10 ->	4	77	---	CSS1803
C-Max I 1.6 TDCi	G8DA, G8DB, G8DD	02.07 - 02.08	4	80	CSS1517	---
C-Max I 1.6 TDCi	G8DA, G8DB, G8DD	03.08 ->	4	80	CSS1538	---
C-Max I 1.6 TDCi	GPDA, HHDA, HHDB	02.07 - 03.08	4	66	CSS1517	---
C-Max I 1.6 TDCi	GPDA, HHDA, HHDB	03.08 ->	4	66	CSS1538	---
C-Max I 1.8	QQDA, QQDB	02.07 - 09.10	4	92	CSS1804	CSS1805
C-Max I 1.8 Flexifuel	Q7DA	02.07 - 09.10	4	92	CSS1804	CSS1805
C-Max I 1.8 TDCi	KKDA	02.07 - 09.10	4	85	---	CSS1806
C-Max I 2.0	AODA, AODB, AODE, SYDA	02.07 - 09.10	4	107	CSS1804	CSS1805
C-Max I 2.0 CNG	SYDA	04.09 - 09.10	4	107	CSS1804	CSS1805
C-Max II 1.6 CNG	MUDA	01.13 ->	4	86	---	CSS720
C-Max II 1.6 EcoBoost	JQDA, JQDB	12.10 ->	4	110	---	CSS1803
C-Max II 1.6 EcoBoost	JTDA, JTDB	12.10 ->	4	134	---	CSS1803
C-Max II 1.6 Flexifuel	MUDA	02.11 ->	4	88	---	CSS720
C-Max II 1.6 LPG	MUDA	02.12 ->	4	88	---	CSS720
C-Max II 1.6 LPG	MUDA	02.12 ->	4	86	---	CSS720
C-Max II 1.6 TDCi	T1DB, T1DA	12.10 ->	4	85	CSS1538	---
C-Max II 1.6 TDCi	T3DA, T3DB	12.10 ->	4	70	CSS1538	---
C-Max II 1.6 Ti	IQDB, IQDA	12.10 ->	4	77	---	CSS720
C-Max II 1.6 Ti	MUDA	02.12 ->	4	88	---	CSS720
C-Max II 1.6 Ti	PNDA	12.10 ->	4	92	---	CSS720
C-Max II 1.6 Ti	XTDA	12.10 ->	4	63	---	CSS720
C-Max II 1.6 Ti	HWDA, HWDB, SHDA, SHDB	12.10 ->	4	92	---	CSS1803
Courier 1.3	J4C	02.96 ->	4	44	CSS1800	---
Courier 1.4 i	FHA	04.96 - 10.99	4	66	CSS1800	---
Courier 1.8 D	RTK	02.96 ->	4	44	CSS1800	---
Courier 1.8 DI	RTP, RTN	09.00 - 08.03	4	55	CSS1800	CSS1806
Ecosport 1.5 Ti	UEJB	10.13 ->	4	82	---	CSS720
Fiesta IV 1.8 DI	RTP, RTN, RTQ	04.00 - 01.02	4	55	CSS1800	CSS1806
Fiesta V 1.25 16V	FUJA, FUJB	05.02 - 06.08	4	55	CSS1807	---
Fiesta V 1.25 16V	FUJA, FUJB	05.02 - 06.08	4	55	CSS1800	CSS1801

Typ Type	Motornummer Engine-No.	Baujahr Year	Zyl. Cyl.	KW	Kurbelwellen- sensor Crankshaft S.	Nocken- wellensensor Camshaft S.
Fiesta V 1.25 16V	M7JA, M7JB	03.03 - 06.08	4	51	CSS1807	---
Fiesta V 1.25 16V	M7JA, M7JB	03.03 - 06.08	4	51	CSS1800	CSS1801
Fiesta V 1.3	A9JA, A9JB	11.01 - 06.08	4	51	CSS1807	CSS1801
Fiesta V 1.3	BAJA	11.01 - 06.08	4	44	CSS1807	---
Fiesta V 1.4 16V	FXJB, FXJA	11.01 - 06.08	4	59	CSS1807	CSS1801
Fiesta V 1.4 16V	FXJB, FXJA	11.01 - 06.08	4	59	CSS1800	CSS1801
Fiesta V 1.4 TDCi	F6JA, F6JB	11.01 - 06.08	4	50	CSS1538	CSS1519
Fiesta V 1.4 TDCi	F6JA, F6JB	11.01 - 06.08	4	50	CSS1807	CSS1519
Fiesta V 1.4 TDCi	F6JA, F6JB	11.01 - 06.08	4	50	CSS1800	---
Fiesta V 1.6 16V	FYJA, FYJB	11.01 - 06.08	4	74	CSS1807	---
Fiesta V 1.6 16V	FYJA, FYJB	11.01 - 06.08	4	74	CSS1800	CSS1801
Fiesta V 1.6 TDCi	HHJA, HHJB	11.04 - 06.08	4	66	CSS1538	---
Fiesta V 1.6 TDCi	HHJA, HHJB	11.04 - 06.08	4	66	CSS1807	---
Fiesta V 1.6 TDCi	HHJA, HHJB	11.04 - 06.08	4	66	CSS1800	---
Fiesta V ST150	N4JB	03.05 - 06.08	4	110	CSS1807	---
Fiesta V ST150	N4JB	03.05 - 06.08	4	110	CSS1804	CSS1805
Fiesta V ST150	N4JB	03.05 - 06.08	4	110	CSS1800	---
Fiesta Van 1.25	SNJA, SNJB	01.09 ->	4	60	CSS1807	CSS1803
Fiesta Van 1.3	A9JA, A9JB	10.03 ->	4	51	CSS1807	CSS1801
Fiesta Van 1.4 TDCi	F6JA, F6JB	10.03 - 12.10	4	50	CSS1538	CSS1519
Fiesta Van 1.4 TDCi	F6JA, F6JB	10.03 - 03.08	4	50	CSS1517	---
Fiesta Van 1.4 TDCi	F6JA, F6JB	10.03 ->	4	50	CSS1800	---
Fiesta Van 1.4 TDCi	F6JB	10.03 - 12.10	4	50	CSS1538	CSS1519
Fiesta Van 1.4 TDCi	F6JB	01.09 ->	4	50	CSS1807	CSS1519
Fiesta Van 1.4 TDCi	KVJA, F6JD	07.10 ->	4	51	CSS1807	CSS1519
Fiesta Van 1.6 TDCi	HHJC, HHJD, HHJE	01.09 ->	4	66	CSS1538	---
Fiesta Van 1.6 TDCi	HHJC, HHJD, HHJE	01.09 ->	4	66	CSS1807	---
Fiesta Van 1.6 TDCi	TZJB, TZJA	02.10 ->	4	70	CSS1807	---
Fiesta VI 1.25	SNJA, SNJB	06.08 ->	4	60	CSS1807	CSS1803
Fiesta VI 1.25	SNJA, SNJB	06.08 ->	4	60	---	CSS1801
Fiesta VI 1.25	STJA, STJB	06.08 ->	4	44	CSS1807	CSS1803
Fiesta VI 1.25	STJA, STJB	06.08 ->	4	44	---	CSS1801
Fiesta VI 1.25 Ti	HXJA, HXJB	10.08 ->	4	88	---	CSS1803
Fiesta VI 1.4	SPJA, SPJC	06.08 ->	4	71	CSS1807	CSS1801
Fiesta VI 1.4 LPG	RTJA, RTJB	01.09 ->	4	68	CSS1807	CSS1801
Fiesta VI 1.4 LPG	RTJA, RTJB	01.09 ->	4	71	CSS1807	CSS1801
Fiesta VI 1.4 TDCi	F6JB	01.09 ->	4	50	CSS1807	CSS1519
Fiesta VI 1.4 TDCi	F6JB	01.09 ->	4	50	CSS1800	---
Fiesta VI 1.4 TDCi	KVJA, F6JD	07.10 ->	4	51	CSS1807	CSS1519
Fiesta VI 1.6 TDCi	HHJC, HHJD, HHJE	06.08 ->	4	66	CSS1807	---
Fiesta VI 1.6 TDCi	HHJC, HHJD, HHJE	10.08 ->	4	66	CSS1538	---
Fiesta VI 1.6 TDCi	HHJF, UBJA	10.08 ->	4	55	CSS1538	---
Fiesta VI 1.6 TDCi	TZJB, TZJA, T3JA	02.10 ->	4	70	CSS1807	---
Fiesta VI 1.6 TDCi	UBJA, HHJF	06.08 ->	4	55	CSS1807	---
Fiesta VI 1.6 Ti	HXJB, HXJA	06.08 ->	4	88	CSS1807	CSS720
Fiesta VI 1.6 Ti	IQJA	09.12 ->	4	77	---	CSS720
Fiesta VI 1.6 Ti	U5JA	12.10 ->	4	99	CSS1807	CSS720
Fiesta VI Van	SNJA, SNJB	01.09 ->	4	60	---	CSS1801
Fiesta VI Van 1.4 TDCi	F6JB	01.09 ->	4	50	CSS1800	---
Focus C-Max 1.6	HWDB, HWDA	10.03 - 03.07	4	74	CSS1807	---
Focus C-Max 1.6	HWDB, HWDA	10.03 - 03.07	4	74	CSS1800	CSS1801
Focus C-Max 1.6 TDCi	G8DA, G8DB	10.03 - 03.07	4	80	CSS1807	---
Focus C-Max 1.6 TDCi	G8DA, G8DB	10.03 - 03.07	4	80	CSS1800	---
Focus C-Max 1.6 TDCi	HHDA, HHDB	02.05 - 03.07	4	66	CSS1807	---
Focus C-Max 1.6 TDCi	HHDA, HHDB	02.05 - 03.07	4	66	CSS1800	---
Focus C-Max 1.6 Ti	SIDA, HXDA	08.04 - 03.07	4	85	CSS1807	CSS720
Focus C-Max 1.6 Ti	SIDA, HXDA	08.04 - 03.07	4	85	CSS1800	---
Focus C-Max 1.8	CSDA, CSDB	10.03 - 03.07	4	88	CSS1804	CSS1805
Focus C-Max 1.8	CSDB, CSDA	10.03 - 03.07	4	88	CSS1800	---

Typ Type	Motornummer Engine-No.	Baujahr Year	Zyl. Cyl.	KW	Kurbelwellen- sensor Crankshaft S.	Nocken- wellensensor Camshaft S.
Focus C-Max 1.8	Q7DA, QQDA, QQDB	04.04 - 03.07	4	92	CSS1804	CSS1805
Focus C-Max 1.8	QQDA, QQDB, Q7DA	04.04 - 03.07	4	92	CSS1800	---
Focus C-Max 1.8	QQDC	09.05 - 03.07	4	90	CSS1807	---
Focus C-Max 1.8 Flexifuel	Q7DA	01.06 - 03.07	4	92	CSS1804	CSS1805
Focus C-Max 1.8 Flexifuel	Q7DA	01.06 - 03.07	4	92	CSS1800	---
Focus C-Max 1.8 TDCi	KKDA	01.05 - 03.07	4	85	CSS1807	---
Focus C-Max 1.8 TDCi	KKDA	01.05 - 03.07	4	85	CSS1800	---
Focus C-Max 2.0	AODA, AODB, SYDA	04.04 - 03.07	4	107	CSS1804	CSS1805
Focus C-Max 2.0	AODA, AODB, SYDA	03.04 - 03.07	4	107	CSS1800	---
Focus C-Max 2.0 TDCi	G6DC, G6DE, G6DF	10.03 - 03.07	4	98	CSS1807	---
Focus C-Max 2.0 TDCi	G6DD, G6DB, G6DG, G6DA	10.03 - 03.07	4	100	CSS1807	---
Focus C-Max 2.0 TDCi	G6DD, G6DB, G6DG, G6DA	10.03 - 03.07	4	100	CSS1800	---
Focus I 1.4 16V	FXDA, FXDD, FXDC, FXDB	10.98 - 11.04	4	55	CSS1807	---
Focus I 1.8 16V	EYDD, EYDC, EYDE, EYDL	10.98 - 11.04	4	85	CSS1807	---
Focus I 1.8 DI / TDDi	BHDB, BHDA	08.99 - 11.04	4	55	CSS1807	CSS1806
Focus I 1.8 TDCi	F9DA, F9DB	03.01 - 11.04	4	85	---	CSS1806
Focus I 1.8 TDCi	FFDA	08.02 - 11.04	4	74	CSS1807	CSS1806
Focus I 1.8 Turbo DI / TDDi	C9DA, C9DB, C9DC	10.98 - 11.04	4	66	CSS1807	CSS1806
Focus I 2.0 16V	EDDC, EDDB, EDDD, EDDF	10.98 - 11.04	4	96	CSS1807	---
Focus II 1.4	ASDB, ASDA	11.04 - 09.12	4	59	CSS1807	---
Focus II 1.4	ASDB, ASDA	11.04 ->	4	59	CSS1800	CSS1801
Focus II 1.6	SHDA, HWDB, SHDB, HWDA	07.04 - 09.12	4	74	CSS1807	CSS720
Focus II 1.6	SHDA, HWDB, SHDB, HWDA	11.04 ->	4	74	CSS1800	CSS1801
Focus II 1.6 LPG	SIDA	10.09 - 07.11	4	85	---	CSS720
Focus II 1.6 TDCi	G8DA, G8DB, G8DD, G8DE	07.04 - 09.12	4	80	CSS1538	---
Focus II 1.6 TDCi	G8DA, G8DB, G8DD, G8DE	11.04 - 03.08	4	80	CSS1517	---
Focus II 1.6 TDCi	G8DA, G8DB, G8DE, G8DD	11.04 - 09.12	4	80	CSS1807	---
Focus II 1.6 TDCi	G8DA, G8DB, G8DE, G8DD	11.04 ->	4	80	CSS1800	---
Focus II 1.6 TDCi	GPDA, GPDC, HHDA, HHDB	01.05 - 03.08	4	66	CSS1517	---
Focus II 1.6 TDCi	GPDA, GPDC, HHDA, HHDB	01.05 - 09.12	4	66	CSS1538	---
Focus II 1.6 TDCi	GPDC, HHDA, GPDB, HHDB	01.05 ->	4	66	CSS1800	---
Focus II 1.6 TDCi	GPDC, HHDA, HHDB, GPDA	01.05 - 09.12	4	66	CSS1807	---
Focus II 1.6 Ti	HXDB, HXDA	11.04 - 09.12	4	85	CSS1807	---
Focus II 1.6 Ti	HXDB, SIDA, HXDA	07.04 - 09.12	4	85	CSS1800	CSS720
Focus II 1.8	QQDB	03.06 - 09.12	4	92	CSS1807	---
Focus II 1.8	QQDB	03.06 ->	4	92	CSS1800	---
Focus II 1.8 Flexifuel	Q7DA	01.06 - 09.12	4	92	CSS1804	CSS1805
Focus II 1.8 Flexifuel	Q7DA	01.06 ->	4	92	CSS1800	---
Focus II 1.8 TDCi	KKDA	01.05 - 03.07	4	85	---	CSS1806
Focus II 1.8 TDCi	KKDA, KKDB	01.05 - 09.12	4	85	CSS1807	CSS1806
Focus II 1.8 TDCi	KKDA, KKDB	01.05 ->	4	85	CSS1800	---
Focus II 2.0	AODA, AODB	11.04 - 09.12	4	107	CSS1804	CSS1805
Focus II 2.0	AODA, AODB	11.04 ->	4	107	CSS1800	---
Focus II 2.0 CNG	SYDA	04.09 - 07.11	4	107	CSS1804	CSS1805
Focus II 2.0 TDCi	G6DD, G6DB, G6DA	11.04 - 09.12	4	100	CSS1807	---
Focus II 2.0 TDCi	G6DD, G6DB, G6DA	11.04 ->	4	100	CSS1800	---
Focus II 2.0 TDCi	G6DE, G6DF	11.04 - 01.08	4	98	CSS1807	---
Focus II 2.5 ST	HYDA	10.05 - 09.12	5	166	CSS1807	---
Focus II 2.5 ST	HYDA	10.05 ->	5	166	CSS1800	---
Focus II Cabriolet 1.6	HWDA, HWDB	10.06 - 07.11	4	74	---	CSS1803
Focus III 1.6 EcoBoost	JQDA, JQDB	04.11 ->	4	110	---	CSS1803
Focus III 1.6 EcoBoost	JTDA, JTDB	04.11 ->	4	134	---	CSS1803
Focus III 1.6 Flexifuel	MUDA	04.11 ->	4	88	---	CSS1803
Focus III 1.6 LPG	MUDA	02.12 ->	4	88	---	CSS720
Focus III 1.6 LPG	MUDA	02.12 ->	4	86	---	CSS720
Focus III 1.6 Ti	IQDB	07.10 ->	4	77	---	CSS720
Focus III 1.6 Ti	PNDA	07.10 ->	4	92	---	CSS720
Focus III 1.6 Ti	XTDA	08.11 ->	4	63	---	CSS720
Focus III 1.6 Ti Flexifuel	MUDA	07.10 ->	4	88	---	CSS720

Typ Type	Motornummer Engine-No.	Baujahr Year	Zyl. Cyl.	KW	Kurbelwellen- sensor Crankshaft S.	Nocken- wellensensor Camshaft S.
Focus III Turnier 1.6 LPG	MUDA	02.12 ->	4	88	---	CSS720
Focus III Turnier 1.6 LPG	MUDA	02.12 ->	4	86	---	CSS720
Focus III Turnier 1.6 Ti	MUDA	02.12 ->	4	88	---	CSS720
Focus III Turnier 1.6 Ti	XTDA	08.11 ->	4	63	---	CSS720
Focus III Turnier 1.6 Ti	IQDB	07.10 ->	4	77	---	CSS720
Focus III Turnier 1.6 Ti	PNDA	07.10 ->	4	92	---	CSS720
Focus III Turnier 1.6 Ti Flexifuel	MUDA	07.10 ->	4	88	---	CSS720
Focus RS	HMDA	10.02 - 11.04	4	158	CSS1807	---
Focus ST170	ALDA	03.02 - 11.04	4	127	CSS1807	---
Fusion 1.25	FUJA, FUJB	08.04 - 12.12	4	55	CSS1807	CSS1803
Fusion 1.25	FUJA, FUJB	08.04 ->	4	55	CSS1800	CSS1801
Fusion 1.4	FXJC, FXJB, FXJA	08.02 - 12.12	4	59	CSS1807	---
Fusion 1.4	FXJC, FXJB, FXJA	08.02 ->	4	59	CSS1800	CSS1801
Fusion 1.4 LPG	UTJA	01.10 - 12.12	4	59	CSS1807	---
Fusion 1.4 TDCi	F6JA, F6JB	08.02 - 07.05	4	50	CSS1538	CSS1519
Fusion 1.4 TDCi	F6JA, F6JB	08.02 - 03.08	4	50	CSS1807	CSS1519
Fusion 1.4 TDCi	F6JA, F6JB	08.02 ->	4	50	CSS1800	---
Fusion 1.6	FYJA, FYJB	08.02 - 11.08	4	74	CSS1807	---
Fusion 1.6	FYJC, FYJA, FYJB	08.02 ->	4	74	CSS1800	CSS1801
Fusion 1.6 TDCi	HHJA, HHJB	11.04 - 12.12	4	66	CSS1538	---
Fusion 1.6 TDCi	HHJA, HHJB	11.04 - 03.08	4	66	CSS1517	---
Fusion 1.6 TDCi	HHJA, HHJB	11.04 - 12.12	4	66	CSS1807	---
Fusion 1.6 TDCi	HHJA, HHJB	11.04 ->	4	66	CSS1800	---
Galaxy 1.8 TDCi	FFWA	05.06 - 06.15	4	74	---	CSS1806
Galaxy 1.8 TDCi	QYWA	05.06 - 06.15	4	92	---	CSS1806
Galaxy 1.9 TDI	ANU, AHU, 1Z	03.95 - 05.06	4	66	---	CSS328
Galaxy 1.9 TDI	ASZ	02.03 - 05.06	4	96	---	CSS328
Galaxy 1.9 TDI	AUY	04.00 - 05.06	4	85	---	CSS328
Galaxy 1.9 TDI	BTB	05.05 - 05.06	4	110	---	CSS328
Galaxy 2.0	AOWA, AOWB	05.06 - 06.15	4	107	CSS1804	CSS1805
Galaxy 2.2 TDCi	Q4BA, Q4WA	03.08 - 12.12	4	129	CSS1517	---
Galaxy 2.3	SEWA	07.07 - 06.15	4	118	---	CSS1802
Galaxy 2.8 i V6	AAA, AMY	11.95 - 04.00	6	128	---	CSS323
Galaxy 2.8 i V6 4x4	AAA, AMY	04.96 - 04.00	6	128	---	CSS323
Galaxy 2.8 V6	AYL	04.00 - 05.06	6	150	---	CSS323
Grand C-Max 1.6 EcoBoost	JQDA, JQDB	04.11 ->	4	110	---	CSS1803
Grand C-Max 1.6 EcoBoost	JTDA, JTDB	04.11 ->	4	134	---	CSS1803
Grand C-Max 1.6 TDCi	T1DB, T1DA	12.10 ->	4	85	CSS1538	---
Grand C-Max 1.6 TDCi	T3DA, T3DB	12.10 ->	4	70	CSS1538	---
Grand C-Max 1.6 Ti	IQDA, IQDB	12.10 ->	4	77	---	CSS1803
Grand C-Max 1.6 Ti	IQDB, IQDA	12.10 ->	4	77	---	CSS720
Grand C-Max 1.6 Ti	PNDA	12.10 ->	4	92	---	CSS720
Ka 1.2	FP4	10.08 ->	4	51	CSS1318	---
Ka 1.3 i	A9B, A9A	08.02 - 11.08	4	51	CSS1800	CSS1801
Ka 1.3 i	J4S, BAA, J4K, J4M, J4P, J4N	09.96 - 11.08	4	44	CSS1800	CSS1801
Ka 1.3 i	JJB	09.96 - 10.20	4	37	CSS1800	---
Ka 1.3 i	JJH, JJD, JJF, JJG, JJJ	06.98 - 11.08	4	36	CSS1800	---
Ka 1.3 TDCi	FD4	10.08 ->	4	55	CSS1303	CSS716
Ka 1.6 i	CCA, CDC, CDB	07.03 - 11.08	4	70	CSS1800	CSS1801
Maverick 2.3 16V	GZ	03.04 ->	4	110	CSS1804	CSS1805
Mondeo II 2.5 ST 200	SGA	05.99 - 11.00	6	151	---	CSS328
Mondeo III 1.8 16V	CGBA, CGBB	11.00 - 08.07	4	81	CSS1804	CSS1805
Mondeo III 1.8 16V	CHBA, CHBB	11.00 - 08.07	4	92	CSS1804	CSS1805
Mondeo III 1.8 SCi	CFBA	06.03 - 08.07	4	96	---	CSS914
Mondeo III 2.0 16V	CJBA, CJBB	11.00 - 08.07	4	107	CSS1804	CSS1805
Mondeo IV 1.6 EcoBoost	JTBB	02.11 - 09.14	4	118	---	CSS1803
Mondeo IV 1.6 Ti	KGBA	07.10 - 09.14	4	88	---	CSS720
Mondeo IV 1.6 Ti	PNBA	03.07 - 09.14	4	92	---	CSS720
Mondeo IV 1.6 Ti	RHBA	03.07 - 09.14	4	81	---	CSS720

Typ Type	Motornummer Engine-No.	Baujahr Year	Zyl. Cyl.	KW	Kurbelwellen- sensor Crankshaft S.	Nocken- wellensensor Camshaft S.
Mondeo IV 1.8 TDCi	FFBA	03.07 - 09.14	4	74	---	CSS1806
Mondeo IV 1.8 TDCi	KHBA, QYBA	06.07 - 12.12	4	92	---	CSS1806
Mondeo IV 2.0	AOBA, AOBC	03.07 - 09.14	4	107	CSS1804	CSS1805
Mondeo IV 2.0 Flexifuel	TBBA, TBBC	03.07 - 09.14	4	107	CSS1804	CSS1805
Mondeo IV 2.0 LPG	TBBA	07.09 - 09.14	4	107	CSS1804	CSS1805
Mondeo IV 2.2 TDCi	Q4BA	03.08 - 10.10	4	129	CSS1517	---
Mondeo IV 2.3	SEBA	07.07 - 09.14	4	118	---	CSS1802
Mondeo IV 2.3	SEBA	07.07 - 09.14	4	118	---	CSS1802
Mondeo IV Turnier 1.6 Ti	KGBA	07.10 - 09.14	4	88	---	CSS720
Mondeo IV Turnier 1.6 Ti	PNBA	03.07 - 12.10	4	92	---	CSS720
Mondeo IV Turnier 1.6 Ti	RHBA	03.07 - 12.12	4	81	---	CSS720
Sierra 2.0 4x4	N9C	01.90 - 02.93	4	88	CSS1306	---
S-Max 1.8 TDCi	FFWA	01.07 ->	4	74	---	CSS1806
S-Max 1.8 TDCi	QYWA	05.06 ->	4	92	---	CSS1806
S-Max 2.0	AOWA, AOWB	05.06 ->	4	107	CSS1804	CSS1805
S-Max 2.0 Flexifuel	TBWA, TBWB	05.06 ->	4	107	CSS1804	CSS1805
S-Max 2.2 TDCi	Q4WA	03.08 ->	4	129	CSS1517	---
S-Max 2.3	SEWA	07.07 ->	4	118	---	CSS1802
Street Ka 1.6	CDRA, CDRB	05.03 - 07.05	4	70	CSS1800	CSS1801
Tourneo Connect 1.8 TDCi	RWPC, RWPA, RWPD	08.06 - 12.13	4	81	---	CSS1806
Tourneo Connect 1.8 Turbo Di	P9PB, P9PA, HCPB, RWPF, P9PC	06.02 - 12.13	4	66	---	CSS1806
Transit 2.3 16V	GZFA, GZFB	04.06 - 08.14	4	107	---	CSS1805

### Honda

Accord VII 2.2 i-CTDi	N22A1	01.04 - 05.08	4	103	---	CSS914
CR-V II 2.2 CTDi	N22A2	02.05 - 09.06	4	103	---	CSS914
CR-V IV 2.0 AWD	R20A9	10.12 ->	4	114	---	CSS300
FR-V 2.2 i CTDi	N22A1	07.05 ->	4	103	---	CSS914
Legend III 3.5 V6 AWD	C35A8	05.06 ->	6	217	CSS1539	---

### Hyundai

Accent I 1.3	G4E-A	01.00 - 11.05	4	55	CSS1701	---
Accent I 1.3	G4E-A	01.00 - 11.05	4	63	CSS1700	---
Accent I 1.3	G4EH	10.94 - 01.00	4	44	CSS1701	---
Accent I 1.3	G4EH	10.94 - 01.00	4	55	CSS1701	---
Accent I 1.3 i 12V	G4EH	10.94 - 01.00	4	62	CSS1701	---
Accent I 1.5	G4EB	01.00 - 11.05	4	66	CSS1700	---
Accent I 1.5	G4EC-G	09.00 - 11.05	4	75	CSS1700	---
Accent I 1.5 i 12V	G4EK	10.94 - 01.00	4	65	CSS1701	---
Accent I 1.5 i 16V	---	12.95 - 01.00	4	73	CSS1701	---
Accent II 1.3	G4EA	01.00 - 11.05	4	55	CSS1602	---
Accent II 1.3	G4EA	01.00 - 11.05	4	63	CSS1602	---
Accent II 1.3	G4EH	08.02 - 11.05	4	62	CSS1602	---
Accent II 1.5 CRDi	D3EA	04.02 - 11.05	3	60	CSS1601	---
Accent II 1.6	G4ED-G	12.02 - 11.05	4	77	CSS1601	---
Accent II 1.6	G4ED-G	12.02 - 11.05	4	77	CSS1602	---
Atos 1.0 i	G4HC	02.98 - 03.02	4	40	---	CSS1603
Atos 1.0 i	G4HC-E	03.01 ->	4	43	---	CSS1603
Atos 1.1	G4HG	03-04 ->	4	46	---	CSS1603
Atos Prime 1.0 i	G4HC	08.99 ->	4	40	---	CSS1603
Atos Prime 1.0 i	G4HC-E	03.01 ->	4	43	---	CSS1603
Atos Prime 1.1	G4HD	06.03 ->	4	43	---	CSS1603
Atos Prime 1.1	G4HG	09.05 ->	4	46	---	CSS1603
Coupe 1.6 16V	G4ED-G	03.02 - 08.09	4	79	CSS1700	---
Coupe 1.6 16V	G4ED-G	03.02 - 08.09	4	77	CSS1700	---
Coupe 1.6 16V	G4GR	03.98 - 04.02	4	85	CSS1701	---
Coupe 1.6 i 16V	4G61	12.96 - 04.02	4	84	CSS1701	---
Coupe 2.0	G4GC-G	03.02 - 08.09	4	102	CSS1701	---
Coupe 2.0	G4GC-G	08.01 - 08.09	4	100	CSS1601	---

Typ Type	Motornummer Engine-No.	Baujahr Year	Zyl. Cyl.	KW	Kurbelwellen- sensor Crankshaft S.	Nocken- wellensensor Camshaft S.
Coupe 2.0 16V	G4GF	08.96 - 04.02	4	102	CSS1701	---
Coupe 2.0 16V	---	03.01 - 04.02	4	99	CSS1701	---
Coupe 2.0 GLS	G4GC-G	02.03 - 08.09	4	105	CSS1601	---
Coupe 2.7 V6	G6BA-G	01.07 - 08.09	6	121	CSS1601	---
Coupe 2.7 V6	G6BA-G	03.02 - 08.09	6	123	CSS1601	---
Cuope 1.6 16V	G4ED-G	03.02 - 08.09	4	77	CSS1602	---
Cuope 1.6 16V	G4ED-G	03.02 - 08.09	4	79	CSS1602	---
Elantra 1.6	G4ED-G	05.03 - 07.06	4	77	CSS1700	---
Elantra 1.6	G4ED-G	06.00 - 07.06	4	79	CSS1700	---
Elantra 1.8	G4BB	06.00 - 07.06	4	97	CSS1601	---
Elantra 2.0	G4GC	06.00 - 07.06	4	104	CSS1601	---
Elantra 2.0	G4GC	10.03 - 07.06	4	105	CSS1601	---
Elantra 2.0	G4GC	06.00 - 07.06	4	104	CSS1602	---
Elantra 2.0	G4GC	10.03 - 07.06	4	105	CSS1602	---
Elantra 2.0	G4GC-G	06.00 - 07.06	4	102	CSS1701	---
Elantra 2.0 CRDi	D4EA	04.01 - 07.06	4	83	CSS1601	---
Elantra 2.0 CRDi	D4EA	04.01 - 07.06	4	83	CSS1602	---
Genesis Coupe 2.0 T	---	04.12 ->	4	204	---	CSS1600
Genesis Coupe 2.0 T	G4KF	01.08 ->	4	157	---	CSS1600
Getz 1.1	G4HD	09.02 - 09.05	4	46	---	CSS1603
Getz 1.1	G4HD	09.05 - 06.09	4	49	---	CSS1603
Getz 1.3	G4E-A	09.03 - 09.05	4	63	CSS1700	---
Getz 1.3 i	G4EA	09.02 - 03.04	4	60	CSS1602	CSS1603
Getz 1.4 i	G4EE	08.05 - 06.09	4	71	CSS1700	---
Getz 1.5 CRDi	D3EA	03.03 - 09.05	3	60	CSS1601	---
Getz 1.6	G4ED-G	09.02 - 09.05	4	77	CSS1601	---
Getz 1.6	G4ED-G	08.05 - 06.09	4	78	CSS1601	---
Getz 1.6	G4ED-G	09.02 - 09.05	4	77	CSS1602	---
Getz 1.6	G4ED-G	08.05 - 06.09	4	78	CSS1602	---
Getz 1.6	G4ED-G	09.02 - 09.05	4	77	CSS1700	---
H-1	G4CS	03.00 - 04.04	4	82	---	CSS1603
H-1 / Starex	G4CS	06.97 - 04.04	4	82	---	CSS1603
i20 1.4	G4FA	09.08 - 12.15	4	74	CSS1605	---
i30 1.4	G4FA	12.11 - 12.15	4	73	CSS1605	---
i30 2.0	G4GC-G, G4GC	10.07 - 11.11	4	105	CSS1601	---
i30 2.0 CRDi	D4EA	10.07 - 11.11	4	103	CSS1601	---
i30 2.0 CRDi	D4EA	10.07 - 11.11	4	100	CSS1602	---
i30 2.0 CRDi	D4EA	10.07 - 11.11	4	103	CSS1602	---
i30 CW 2.0	G4GC-G, G4GC	02.08 - 06.12	4	105	CSS1601	---
i30 CW 2.0 CRDi	D4EA	10.08 - 06.12	4	100	CSS1601	---
i30 CW 2.0 CRDi	D4EA	02.08 - 06.12	4	103	CSS1601	---
i30 CW 2.0 CRDi	D4EA	10.08 - 06.12	4	100	CSS1602	---
i30 CW 2.0 CRDi	D4EA	02.08 - 06.12	4	103	CSS1602	---
i30 Estate 1.4	G4FA	06.12 - 12.15	4	73	CSS1605	---
i40 1.6 GDI	G4FD	07.11 ->	4	99	CSS1605	---
i40 1.6 GDI	G4FD	03.12 ->	4	99	CSS1605	---
ix35 1.6	G4FD	11.10 ->	4	99	CSS1605	---
ix35 2.0	G4KD	01.10 ->	4	120	---	CSS1600
ix35 2.0 4WD	G4KD	01.10 ->	4	120	---	CSS1600
Lantra II 1.5 12V	---	12.96 - 09.00	4	65	CSS1701	---
Lantra II 1.6 16V	4G61	11.95 - 09.00	4	84	CSS1701	---
Lantra II 1.6 i	G4GR	11.95 - 09.00	4	66	CSS1701	---
Lantra II 1.8 16V	G4GM	11.95 - 09.00	4	94	CSS1701	---
Lantra II 2.0 16V	G4GF	08.96 - 09.00	4	102	CSS1701	---
Lantra II Wagon 1.5 12V	G4EK	04.97 - 10.00	4	65	CSS1701	---
Lantra II Wagon 1.6 i	G4GR	02.96 - 10.00	4	66	CSS1701	---
Lantra II Wagon 1.8 16V	G4GM	02.96 - 10.00	4	94	CSS1701	---
Lantra II Wagon 2.0 16V	G4GF	12.96 - 10.00	4	102	CSS1701	---
Matrix 1.5 CRDi	D3EA	10.01 - 08.10	3	60	CSS1601	---

Typ Type	Motornummer Engine-No.	Baujahr Year	Zyl. Cyl.	KW	Kurbelwellen- sensor Crankshaft S.	Nocken- wellensensor Camshaft S.
Matrix 1.6	G4ED-G	06.01 - 08.10	4	76	CSS1601	---
Matrix 1.6	G4ED-G	06.01 - 08.10	4	76	CSS1602	---
Matrix 1.8	G4GB-G	06.01 - 08.10	4	90	CSS1602	---
Matrix 1.8	G4GB-G	06.01 - 08.10	4	90	CSS1601	---
Santa FÉ I 2.0	G4BP	08.01 - 03.06	4	99	---	CSS1603
Santa FÉ I 2.0 CRDi	D4EA	08.01 - 03.06	4	83	CSS1601	---
Santa FÉ I 2.0 CRDi	D4EA	08.01 - 03.06	4	83	CSS1602	---
Santa FÉ I 2.4 16V	G4JS-G	02.01 - 03.06	4	100	---	CSS1603
Santa FÉ I 2.4 16V	G4JS-G	02.01 - 03.06	4	107	---	CSS1603
Santa FÉ II 2.4	G4KE	11.10 ->	4	128	---	CSS1600
Sonata IV 2.0 16V	G4JP-EG	10.01 - 11.04	4	96	---	CSS1603
Sonata IV 2.0 16V	G4JP-G	06.98 - 10.01	4	100	CSS1601	---
Sonata IV 2.0 16V	G4JP-G	06.98 - 10.01	4	100	CSS1602	CSS1603
Sonata IV 2.4 16V	G4BS	03.98 - 10.01	4	105	---	CSS1603
Sonata IV 2.7 V6	G6BA-G	10.01 - 11.04	6	127	CSS1601	---
Sonata V 2.0 CRDi	D4EA	02.06 - 12.10	4	100	CSS1601	---
Sonata V 2.0 CRDi	D4EA	02.06 - 12.10	4	103	CSS1601	---
Sonata V 2.0 CRDi	D4EA	03.09 - 12.10	4	110	CSS1601	---
Sonata V 2.0 CRDi	D4EA	02.06 - 12.10	4	100	CSS1602	---
Sonata V 2.0 CRDi	D4EA	02.06 - 12.10	4	103	CSS1602	---
Sonata V 2.0 CRDi	D4EA	03.09 - 12.10	4	110	CSS1602	---
Trajjet 2.0	G4GC-G	01.04 - 07.08	4	103	CSS1601	CSS1603
Trajjet 2.0	G4JP-G	03.00 - 07.08	4	100	CSS1601	CSS1603
Trajjet 2.0	G4JP-G	03.00 - 07.08	4	100	CSS1602	CSS1603
Trajjet 2.0 CRDi	D4EA	04.01 - 07.08	4	83	CSS1602	---
Trajjet 2.7 V6	G6BA-G	09.00 - 07.08	6	127	CSS1601	---
Tucson 2.0	G4GC	08.04 - 03.10	4	104	CSS1602	---
Tucson 2.0 CRDi	D4EA	01.06 - 03.10	4	100	CSS1601	---
Tucson 2.0 CRDi	D4EA	01.09 - 03.10	4	110	CSS1601	---
Tucson 2.0 CRDi	D4EA	08.04 - 03.10	4	83	CSS1602	---
<b>Kia</b>						
Carens II 2.0 CVVT	G4GC	08.04 ->	4	102	CSS1601	---
Carens IV 1.6 GDI	G4FD	03.13 ->	4	99	CSS1605	---
Cee'd 1.4 CVVT	G4FA	05.12 ->	4	73	CSS1605	---
Cee'd 1.4 CVVT	G4FA-L	05.12 ->	4	66	CSS1605	---
Cee'd 1.6 GDI	G4FD	05.12 ->	4	99	CSS1605	---
Cee'd 1.6 GT	G4FJ	06.13 ->	4	150	CSS1605	---
Cee'd 2.0	G4GC	12.06 - 12.12	4	105	CSS1601	---
Cee'd 2.0	G4GC	09.07 - 12.12	4	105	CSS1601	---
Cee'd Sportswagon 1.4 CVVT	G4FA	09.12 ->	4	73	CSS1605	---
Cee'd Sportswagon 1.6 GDI	G4FD	09.12 ->	4	99	CSS1605	---
Cee'd SW 1.4	G4FA	10.10 - 12.12	4	77	CSS1605	---
Cerato 2.0	G4GC	04.04 ->	4	105	CSS1601	---
Cerato 2.0	G4GC	04.04 ->	4	105	CSS1601	---
Magentis 2.0	G4JP	05.01 ->	4	100	---	CSS1603
Magentis 2.5 V6	G6BV	05.01 ->	6	124	---	CSS1603
Optima 2.0	---	09.10 ->	4	204	---	CSS1600
Optima 2.0	G4KD	03.12 ->	4	125	---	CSS1600
Optima 2.4	---	09.10 ->	4	149	---	CSS1600
Optima 2.4 Hybrid	---	09.11 ->	4	154	---	CSS1600
Picanto 1.0	G4HE	04.04 ->	4	45	---	CSS1603
Picanto 1.1	G4HG	04.04 ->	4	48	---	CSS1603
Pro Cee'd 1.4 CVVT	G4FA	03.13 ->	4	73	CSS1605	---
Pro Cee'd 1.6 GDI	G4FD	03.13 ->	4	99	CSS1605	---
Pro Cee'd 2.0	G4GC	02.08 - 09.12	4	105	CSS1601	---
Pro Cee'd 2.0 LPG	G4GC	01.09 - 12.09	4	105	CSS1601	---
Sorento I 2.4	G4JS	08.02 ->	4	102	---	CSS1603
Sorento II 2.4 CVVT	G4KE	11.09 ->	4	128	---	CSS1600

Typ Type	Motornummer Engine-No.	Baujahr Year	Zyl. Cyl.	KW	Kurbelwellen- sensor Crankshaft S.	Nocken- wellensensor Camshaft S.
Soul 1.6 GDI	G4FD	06.11 ->	4	103	CSS1605	---
Sportage 1.6 GDI	G4FD	02.11 ->	4	99	CSS1605	---
Sportage 2.0 i 16V	G4GC	09.04 ->	4	104	CSS1601	---
<b>Lancia</b>						
Dedra 1.6 16V	182 A4.000	01.96 - 07.99	4	76	CSS1304	---
Dedra SW 1.6 16V	182 A4.000	01.96 - 07.99	4	76	CSS1304	---
Delta I 1.5	831 A1.000, 831 B1.000	09.79 - 12.92	4	63	CSS1306	---
Delta I 1.6 GT	831 A4.000	11.82 - 04.86	4	77	CSS1306	---
Delta I 1.6 GT i.e.	831 B7.000	08.86 - 08.88	4	80	CSS1306	---
Delta I 1.6 HF Turbo	831 B3.000	08.86 - 08.88	4	103	CSS1306	---
Delta I 2.0 16V HF Eyo Intergrale	831 D5.000	03.89 - 09.91	4	144	CSS1306	---
Delta I 2.0 16V HF Intergrale	831 B5.000	11.86 - 08.88	4	122	CSS1306	---
Delta I 2.0 HF Intergrale	831 C5.000	10.87 - 02.89	4	133	CSS1306	---
Delta I 2.0 HF Intergrale	831 C5.000	12.86 - 12.92	4	130	CSS1306	---
Delta II 1.6 i.e.	182 A6.000	03.96 - 08.99	4	66	CSS1304	---
Delta II 1.6 i.e.	182 A6.000	03.96 - 08.99	4	66	---	CSS1308
Delta II 1.6 i.e. 16V	182 A4.000	01.96 - 08.99	4	76	CSS1304	---
Delta III 1.6 D Multijet	198 A2.000	09.08 - 08.14	4	88	CSS1300	---
Delta III 1.8	939 B1.000	01.09 - 08.14	4	147	CSS1317	CSS716
Delta III 1.9 D Multijet	844 A1.000	01.09 - 08.14	4	140	CSS1300	---
Delta III 2.0 D Multijet	198 A5.000, 198 A8.000	09.08 - 08.14	4	121	CSS1300	---
Lybra 1.6 16V	182 A4.000	07.99 - 10.05	4	76	CSS1304	CSS1308
Lybra 1.9 JTD	937 A2.000	05.01 - 10.05	4	85	CSS1317	---
Lybra 1.9 JTD	AR 37101	09.00 - 05.01	4	81	---	---
Lybra 2.4 JTD	841C.000	05.02 - 10.05	5	110	CSS1317	---
Lybra SW 1.6 16V	182 A4.000	07.99 - 10.05	4	76	CSS1304	CSS1308
Musa 1.3 D Multijet	188 A9.000	10.04 - 09.12	4	51	---	CSS716
Musa 1.3 D Multijet	199 A3.000	09.06 - 09.12	4	66	---	CSS716
Musa 1.3 D Multijet	199 A3.000	09.06 - 09.12	4	66	CSS1303	---
Musa 1.3 D Multijet	199 B1.000	03.09 - 09.12	4	70	CSS1303	CSS716
Musa 1.3 Multijet	188 A9.000	10.04 - 09.12	4	51	CSS1303	---
Musa 1.4	350 A1000	09.05 - 09.12	4	57	CSS1318	---
Musa 1.6 D Multijet	350 A2.000	07.08 - 09.12	4	88	CSS1300	---
Musa 1.6 D Multijet	350 A2.000, 350 A3.000	07.08 - 09.12	4	85	CSS1300	---
Musa 1.9 D Multijet	188 B2000	10.04 - 09.12	4	74	CSS1317	---
Phedra 2.0	RFN (EW10J4)	09.02 - 11.10	4	100	CSS1516	---
Phedra 2.0 JTD	RHM	07.03 - 11.10	4	79	CSS1516	---
Phedra 2.0 JTD	RHW (DW10ATED4)	09.02 - 11.10	4	80	CSS1516	---
Phedra 2.2 JTD	4HW (DW12ATED4)	09.02 - 11.10	4	94	CSS1516	---
Phedra 3.0 V6	ES9J4S	09.02 - 11.10	6	150	CSS1522	---
Prisma 1.5	831 B1.000	08.86 - 02.92	4	59	CSS1306	---
Prisma 1.6	831 A4.000	01.83 - 04.86	4	77	CSS1306	---
Prisma 1.6 i.e	831 B7.000	05.86 - 12.89	4	80	CSS1306	---
Thema 2000 16V Turbo	834 C1.000	12.88 - 06.90	4	133	CSS1306	---
Thema 2000 i.e.	834 B.048	03.86 - 09.88	4	83	CSS1306	---
Thesis 2.4 JTD	841 C000	07.02 - 07.09	5	110	CSS1317	---
Thesis 2.4 JTD	841 G000	05.03 - 07.09	5	129	CSS1300	CSS1301
Y 1.2	840 A3.000, 188 A4.000	03.96 - 09.03	4	44	CSS1305	CSS1307
Y 1.4 12V	840 A2.000	10.96 - 09.03	4	59	---	CSS1307
Y 1.4 12V	840 A4.000	03.96 - 09.03	4	55	---	CSS1307
Y10 1.0 Turbo	156 A1.000	03.85 - 02.89	4	62	CSS1306	---
Ypsilon 0.9 Twinair	312 A2.000	05.11 ->	2	63	CSS1321	---
Ypsilon 1.2	188 A4000	10.03 - 12.11	4	44	CSS1318	---
Ypsilon 1.2 Bifuel	169 A4.000	05.11 ->	4	49	CSS1318	---
Ypsilon 1.3 D Multijet	199 A2.000	09.06 - 12.11	4	55	CSS1303	---
Ypsilon 1.3 D Multijet	199 A3.000	09.06 - 12.11	4	66	CSS1303	CSS716
Ypsilon 1.3 D Multijet	199 A3.000	05.07 - 12.11	4	77	CSS1303	---
Ypsilon 1.3 JTD	188 A9.000	10.03 - 12.11	4	51	CSS1303	---

Typ Type	Motornummer Engine-No.	Baujahr Year	Zyl. Cyl.	KW	Kurbelwellen- sensor Crankshaft S.	Nocken- wellensensor Camshaft S.
Ypsilon 1.3 Multijet	199 B1.000	05.11 - 12.11	4	70	CSS1303	CSS716
Ypsilon 1.4	350 A1000	02.06 - 12.11	4	57	CSS1318	---
Ypsilon 1.4 LPG	350 A1.000	11.10 - 12.11	4	57	CSS1318	---
Zeta 2.0 16V	RFN	07.00 - 09.02	4	100	CSS1513	---
Zeta 2.0 16V	RFV	05.98 - 07.00	4	97	CSS1500	---
Zeta 2.0 JTD	RHW, RHZ	09.99 - 09.02	4	80	CSS1516	---
Zeta 2.0 Turbo	RGX	05.95 - 09.02	4	108	CSS1500	---
Zeta 2.1 TD	P8C	05.96 - 09.99	4	80	CSS1500	---

### Land Rover

Freelander 2 2.2 eD4	DW12BTED4, 224DT	08.10 - 10.14	4	110	CSS1517	---
Freelander 2 2.2 SD4 4x4	224DT	08.10 - 10.14	4	140	CSS1517	---
Range Rover III 3.6 D 4x4	368DT	04.06 - 08.12	8	200	---	CSS720
Range Rover III 4.4 D 4x4	448DT	07.10 - 08.12	8	230	---	CSS720
Range Rover IV 4.4 D V8 4x4	448DT	08.12 ->	8	250	---	CSS720
Range Rover Sport 3.6 D 4x4	368DT	04.06 - 03.13	8	200	---	CSS720

### Maserati

228 2.8 i	---	12.86 - 12.90	6	184	CSS1306	---
420/430 420 i	470...	01.87 - 12.88	6	138	CSS1306	---
Biturbo 2.24V	475	03.89 - 12.94	6	180	CSS1306	---
Biturbo 4.24V	475	04.90 - 12.94	6	180	CSS1306	---
Biturbo Coupe 2.0	452	07.85 - 04.87	6	136	CSS1306	---
Biturbo Coupe Si 2.0	471	09.87 - 12.88	6	151	CSS1306	---
Biturbo Ghibli II 2.0 24V	---	05.92 ->	6	225	CSS1306	---
Biturbo Quattroporte II 2.0	24V DOHC	03.94 ->	6	211	CSS1306	---
Biturbo Quattroporte II 2.8	---	03.94 ->	6	209	CSS1306	---
Biturbo Spider 2.0	452	07.85 - 04.87	6	136	CSS1306	---
Shamal 3.2	---	12.89 - 11.95	8	240	CSS1306	---

### Mazda

2 1.25	FUJA	04.03 ->	4	55	CSS1800	CSS1801
2 1.4	FXJA	04.03 ->	4	59	---	CSS1801
2 1.4 CD	F6JA, F6JB	04.03 ->	4	50	CSS1517	CSS1519
2 1.6	FYJA	04.03 ->	4	74	CSS1800	CSS1801
3 1.6 DI Turbo	Y601	06.04 - 06.09	4	80	CSS1517	---
3 1.6 MZR CD	Y601	06.09 ->	4	80	CSS1517	---
3 2.0	LF17	10.03 - 06.09	4	110	---	CSS1805
3 2.0	LF17	02.04 - 06.09	4	110	---	CSS1805
3 2.0 MZR	LF17, LF-DE	06.09 ->	4	110	CSS1703	CSS1802
3 2.0 MZR DISI	LF5H, LF5W	06.09 ->	4	111	CSS1703	CSS1802
3 2.3 MPS Turbo	L3KG	06.09 ->	4	191	CSS1703	CSS1802
5 1.8	L823	03.05 ->	4	85	---	CSS1802
5 2.0	LF5H	09.10 ->	4	110	CSS1703	CSS1802
5 2.0	LFF7	03.05 ->	4	107	CSS1703	CSS1802
6 1.8	L813	08.02 - 08.07	4	88	---	CSS1805
6 1.8 MZR	L813	08.07 ->	4	88	---	CSS1802
6 2.0	LF17, LF18	06.02 - 08.07	4	104	---	CSS1805
6 2.0 MZR	LF17	08.07 ->	4	108	---	CSS1805
6 2.3	L3C1	06.02 - 08.07	4	122	---	CSS1805
6 Sport 1.8 MZR	L813	08.07 ->	4	88	---	CSS1802
6 Sport 2.0 MZR	LF17	08.07 ->	4	108	---	CSS1805
MPV II 2.3	L828, L8-DE	07.02 - 02.06	4	93	CSS1703	CSS1802
MX-5 III 1.8	L828, L8-DE	03.05 ->	4	93	---	CSS1802
MX-5 III 2.0	LF62, LF-DE	03.05 ->	4	118	CSS1703	CSS1802
Premacy 1.8	FP	07.99 - 03.05	4	74	---	CSS1802

### Mercedes

400 SE, SEL/S420 (W140)	M 119.971	02.91 - 10.98	8	210	CSS401	CSS402
-------------------------	-----------	---------------	---	-----	--------	--------

Typ Type	Motornummer Engine-No.	Baujahr Year	Zyl. Cyl.	KW	Kurbelwellen- sensor Crankshaft S.	Nocken- wellensensor Camshaft S.
600 SE, SEL (W140)	M 120.980, M 120.982	04.91 - 12.92	12	300	CSS401	---
A 140 (W168)	M 166.940	07.97 - 08.04	4	60	CSS400	CSS407
A 140 (W168)	M 166.960	01.01 - 08.04	4	60	---	CSS407
A 140 (W169)	M 166.940	10.97 - 12.97	4	60	CSS401	---
A 140 (W169)	M 166.960	01.01 - 08.04	4	60	CSS400	---
A 150 (W169)	M 266.920	09.04 - 06.12	4	70	CSS400	CSS403
A 160 (W168)	M 166.960	07.97 - 08.04	4	75	CSS400	CSS407
A 160 (W169)	M 166.960	10.97 - 12.97	4	75	CSS401	---
A 160 (W169)	M 266.920	04.09 - 06.12	4	70	CSS400	CSS403
A 160 CDI (W168)	OM 668.940	02.01 - 08.04	4	55	---	CSS407
A 160 CDI (W168)	OM 668.941 (07.98-.)	07.98 - 02.01	4	44	---	CSS407
A 160 CDI (W169)	OM 640.942	09.04 - 06.12	4	60	---	CSS407
A 160 CDI (W169)	OM 668.940	02.01 - 08.04	4	55	CSS400	---
A 160 CDI (W169)	OM 668.941	07.98 - 02.01	4	44	CSS400	---
A 160 CDI / d (W176)	OM 607.951	06.13 ->	4	66	CSS1537	---
A 170 (W169)	M 266.940	09.04 - 06.12	4	85	CSS400	CSS402
A 170 CDI (W168)	OM 668.940 (09.98-.)	07.98 - 02.01	4	66	---	CSS407
A 170 CDI (W168)	OM 668.942	02.01 - 08.04	4	70	---	CSS407
A 170 CDI (W169)	OM 668.940	07.98 - 02.01	4	66	CSS400	---
A 180 (W169)	M 266.960	04.09 - 06.12	4	85	CSS400	CSS403
A 180 CDI (W169)	OM 640.940	09.04 - 06.12	4	80	CSS400	CSS407
A 180 CDI (W176)	OM 607.951	06.12 ->	4	80	CSS1537	---
A 180 CDI (W176)	OM 651.901	06.12 ->	4	80	CSS406	---
A 190 (W168)	M 166.990	03.99 - 08.04	4	92	CSS400	CSS407
A 200 (W169)	M 266.960	09.04 - 06.12	4	100	CSS400	CSS403
A 200 CDI (W169)	OM 640.941	09.04 - 06.12	4	103	CSS400	CSS402
A 200 CDI (W176)	OM 651.901	06.12 ->	4	100	CSS406	---
A 200 CDI/d (W176)	OM 651.930	02.14 ->	4	100	CSS406	---
A 200 CDI/d 4-matic (W176)	OM 651.930	02.14 ->	4	100	CSS406	---
A 200 Turbo (W169)	M 266.980	09.05 - 06.12	4	142	CSS400	CSS403
A 210 (W168)	M 166.995	03.02 - 08.04	4	103	CSS400	CSS407
A 220 CDI (W176)	OM 651.930	09.12 ->	4	125	CSS406	---
A 220 CDI (W176)	OM 651.930	01.14 ->	4	120	CSS406	---
A 220 CDI 4-matic (W176)	OM 651.930	09.12 ->	4	125	CSS406	---
A 220 d (W176)	OM 651.930	07.15 ->	4	130	CSS406	---
A 220 d 4-matic (W176)	OM 651.930	07.15 ->	4	130	CSS406	---
B 150 (W245)	M 266.920	03.05 - 11.11	4	70	CSS400	CSS403
B 160 (W245)	M 266.920	04.09 - 11.11	4	70	CSS400	CSS403
B 160 CDI (W246)	OM 607.951	05.13 ->	4	66	CSS1537	---
B 170 (W245)	M 266.940	03.05 - 11.11	4	85	CSS400	CSS403
B 170 NGT (W245)	M 266.960	04.08 - 11.11	4	85	---	CSS403
B 180 (W245)	M 266.940	04.09 - 11.11	4	85	CSS400	CSS403
B 180 CDI (W242, W246)	OM 651.901	11.11 ->	4	80	CSS406	---
B 180 CDI (W245)	OM 640.940	03.05 - 11.11	4	80	CSS400	CSS407
B 180 CDI (W246)	OM 607.951	02.13 ->	4	80	CSS1537	---
B 180 NGT (W245)	M 266.900	04.08 - 11.11	4	85	---	CSS403
B 200 (W245)	M 266.960	03.05 - 11.11	4	100	CSS400	CSS403
B 200 CDI (W242, W246)	OM 651.901	11.11 ->	4	100	CSS406	---
B 200 CDI (W245)	OM 640.941	03.05 - 11.11	4	103	---	CSS407
B 200 CDI (W245)	OM 640.941	03.05 - 11.11	4	100	---	CSS407
B 200 CDI (W245)	OM 640.941	03.05 - 11.11	4	103	CSS400	CSS402
B 200 CDI / d 4-matic (W242, W246)	OM 651.930	08.14 ->	4	100	CSS406	---
B 200 CDI/d (W242, W246)	OM 651.930	08.14 ->	4	100	CSS406	---
B 200 Turbo (W245)	M 266.980	03.05 - 11.11	4	142	CSS400	CSS403
B 220 CDI (W242, W246)	OM 651.930	11.11 ->	4	125	CSS406	---
B 220 CDI/d (W242, W246)	OM 651.930	06.13 ->	4	120	CSS406	---
B 220 CDI/d (W242, W246)	OM 651.930	09.14 ->	4	130	CSS406	---
B 220 CDI/d (W242, W246)	OM 651.930	09.14 ->	4	130	CSS406	---
C 180 (W202)	M 111.921	11.94 - 05.00	4	89	CSS400	CSS404

Typ Type	Motornummer Engine-No.	Baujahr Year	Zyl. Cyl.	KW	Kurbelwellen- sensor Crankshaft S.	Nocken- wellensensor Camshaft S.
C 180 (W202)	M 111.921	09.95 - 04.00	4	89	CSS401	---
C 180 (W202)	M 111.921, M 111.920	03.93 - 05.00	4	90	---	CSS404
C 180 BlueTEC / d (S205)	OM 626.951	09.14 ->	4	85	CSS405	---
C 180 BlueTEC / d (W205)	OM 626.951	05.14 ->	4	85	CSS405	---
C 180 CGI (W204)	M 271.820	01.07 - 01.14	4	115	CSS405	CSS403
C 180 Coupe (C204)	M 271.820	06.11 ->	4	115	CSS405	---
C 180 Kompressor (W203)	M 271.946	05.02 - 02.07	4	105	CSS400	CSS402
C 180 Kompressor (W204)	M 271.910	01.08 - 01.14	4	115	CSS400	CSS403
C 180 Kompressor (W204)	M 271.952	01.07 - 01.14	4	115	CSS400	---
C 200 (W202)	M 111.941, M 111.945	01.94 - 05.00	4	100	CSS400	CSS404
C 200 BlueTEC / d (S205)	OM 626.951	09.14 ->	4	100	CSS405	---
C 200 BlueTEC / d (W205)	OM 626.951	05.14 ->	4	100	CSS405	---
C 200 CDI (CL203)	OM 646.962	03.03 - 05.08	4	90	---	CSS407
C 200 CDI (W202)	OM 611.960	03.98 - 05.00	4	75	CSS401	CSS407
C 200 CDI (W203)	OM 611.962	09.00 - 02.07	4	85	---	CSS407
C 200 CDI (W203)	OM 611.962	02.01 - 02.07	4	75	---	CSS407
C 200 CDI (W203)	OM 646.962	04.03 - 02.07	4	90	---	CSS407
C 200 CDI (W204)	OM 646.811, OM 646.812	01.07 - 12.10	4	100	---	CSS407
C 200 CGI (W204)	M 271.820	01.07 - 01.14	4	135	CSS405	CSS403
C 200 CGI Coupe (C204)	M 271.820	06.11 ->	4	135	CSS405	---
C 200 CGI Kompressor (CL203)	M 271.942	07.03 - 02.07	4	125	CSS400	CSS402
C 200 CGI Kompressor (W203)	M 271.942	07.03 - 02.07	4	125	CSS400	CSS402
C 200 d (W202)	OM 604.915	10.96 - 05.00	4	88	CSS401	---
C 200 d (W205)	OM 651.921	10.15 ->	4	100	CSS406	---
C 200 Kompressor (W202)	M 111.944	11.96 - 05.00	4	141	CSS401	---
C 200 Kompressor (W202)	M 111.944	10.95 - 05.00	4	132	CSS401	CSS404
C 200 Kompressor (W203)	M 271.940	05.02 - 02.07	4	120	CSS400	CSS402
C 200 Kompressor (W204)	M 271.950	01.07 - 01.14	4	135	CSS400	CSS403
C 220 BlueTEC/d (W205)	OM 651.921	12.13 ->	4	125	CSS406	---
C 220 BlueTEC/d (W205)	OM 651.921	03.14 - 04.16	4	120	CSS406	---
C 220 CDI (C204)	---	06.11 ->	4	120	CSS400	---
C 220 CDI (W202)	OM 611.960	09.97 - 05.00	4	92	---	CSS407
C 220 CDI (W202)	OM 611.960	09.97 - 05.00	4	92	CSS401	---
C 220 CDI (W203)	OM 611.962	05.00 - 02.07	4	100	---	CSS407
C 220 CDI (W203)	OM 611.962, OM 646.963	05.00 - 02.07	4	105	---	CSS407
C 220 CDI (W203)	OM 646.963	02.03 - 02.07	4	110	---	CSS407
C 220 CDI (W204)	OM 646.811	01.07 - 11.08	4	125	---	CSS407
C 220 CDI (W204)	OM 646.811	01.07 - 11.08	4	120	CSS400	CSS407
C 220 CDI (W204)	OM 651.911	12.08 - 01.14	4	125	CSS406	---
C 220 CDI (W204)	OM 651.911	10.08 - 01.14	4	120	CSS406	---
C 220 CDI 4-matic (W204)	OM 651.912	02.13 - 01.14	4	125	CSS406	---
C 220 CDI Coupe (C204)	OM 651.911	06.11 ->	4	125	CSS406	---
C 220 CDI Coupe (C204)	OM 651.911	06.11 ->	4	120	CSS406	---
C 220 CDI Coupe (CL203)	OM 611.962	03.01 - 01.04	4	105	---	CSS407
C 220 CDI Coupe (CL203)	OM 611.962	03.01 - 01.04	4	100	---	CSS407
C 220 CDI Coupe (CL203)	OM 646.963	02.04 - 05.08	4	110	---	CSS407
C 220 d (W202)	OM 604.910	07.96 - 05.00	4	55	CSS401	---
C 220 d (W202)	OM 604.910	08.93 - 05.00	4	70	CSS401	---
C 220 d 4-matic (W205)	OM 651.921	04.15 ->	4	125	CSS406	---
C 220 d 4-matic Cabriolet (A205)	OM 651.921	06.16 ->	4	125	CSS406	---
C 220 d 4-matic Coupe (C205)	OM 651.921	04.16 ->	4	125	CSS406	---
C 220 d Cabriolet (A205)	OM 651.921	06.16 ->	4	125	CSS406	---
C 220 d Coupe (C205)	OM 651.921	10.15 ->	4	125	CSS406	---
C 220 d Coupe (C205)	OM 651.921	10.15 ->	4	120	CSS406	---
C 230 (W202)	M 111.974	06.96 - 06.97	4	110	CSS401	CSS404
C 230 (W203)	M 272.920	01.05 - 02.07	6	150	CSS405	---
C 230 (W204)	M 272.921	01.07 - 01.14	6	150	---	CSS402
C 230 4-matic (W204)	M 272.911	07.07 - 01.14	6	150	CSS405	---
C 230 Kompressor (W202)	M 111.975	10.95 - 05.00	4	142	CSS401	CSS404

Typ Type	Motornummer Engine-No.	Baujahr Year	Zyl. Cyl.	KW	Kurbelwellen- sensor Crankshaft S.	Nocken- wellensensor Camshaft S.
C 230 Kompressor (W203)	M 271.948	02.04 - 02.07	4	141	CSS400	CSS402
C 230 Sportcoupe (CL203)	M 272.920	01.05 - 05.08	6	150	CSS405	---
C 240 (W202)	M 112.910	06.97 - 05.00	6	125	CSS400	CSS402
C 240 (W203)	M 112.912	05.00 -02.07	6	125	CSS400	CSS402
C 250 BluteTEC/d (W205)	OM 651.921	02.14 ->	4	150	CSS406	---
C 250 BluteTEC/d 4-matic (W205)	OM 651.921	02.14 ->	4	150	CSS406	---
C 250 CDI (W204)	OM 651.911	08.08 - 01.14	4	150	CSS406	---
C 250 CDI 4-matic (W204)	OM 651.912	01.11 - 01.14	4	150	CSS406	---
C 250 CDI Coupe (C204)	OM 651.911	06.11 ->	4	150	CSS406	---
C 250 CGI (W204)	M 271.860	07.09 - 01.14	4	150	---	CSS403
C 250 CGI (W204)	M 271.860	07.09 - 01.14	4	150	CSS405	---
C 250 Coupe (C204)	M 271.860	06.11 ->	4	150	CSS405	CSS403
C 250 d 4-matic Coupe (C205)	OM 651.921	04.16 ->	4	150	CSS406	---
C 250 d Cabriolet (A205)	OM 651.921	06.16 ->	4	150	CSS406	---
C 250 d Coupe (C205)	OM 651.921	10.15 ->	4	150	CSS406	---
C 250 Turbo D (W202)	OM 650.960	10.95 - 05.00	5	110	CSS401	---
C 270 CDI (W203)	OM 612.962	12.00 - 02.07	5	125	---	CSS407
C 270 CDI (W203)	OM 612.962	12.00 - 02.07	5	120	---	CSS407
C 280 (W202)	M 104.941	05.93 - 05.00	6	142	CSS401	CSS404
C 280 (W202)	M 112.920	06.97 - 05.00	6	125	CSS400	CSS402
C 280 (W203)	M 272.940	01.05 - 02.07	6	170	CSS405	---
C 280 (W204)	M 272.947	01.07 - 01.14	6	170	CSS405	CSS403
C 280 4-matic (W203)	M 272.941	01.05 - 02.07	6	170	CSS405	---
C 280 4-matic (W204)	M 272.948	07.07 - 01.14	6	170	CSS405	---
C 30 CDI AMG (CL203)	OM 612.990	09.02 - 05.08	5	170	---	CSS407
C 30 CDI AMG (W203)	OM 612.990	01.03 - 02.07	5	170	---	CSS407
C 300 (W204)	M 272.947	07.09 - 01.14	6	170	CSS405	CSS403
C 300 (W204)	M 276.957	02.11 - 01.14	6	185	CSS406	---
C 300 4-matic (W204)	M 272.947	07.07 - 01.14	6	170	---	CSS403
C 300 4-matic (W204)	M 272.948	07.07 - 01.14	6	170	CSS405	---
C 300 4-matic (W204)	M 276.957	02.11 - 01.14	6	185	CSS406	---
C 300 BlueTEC Hybrid/h (W205)	OM 651.921	05.14 ->	4	150	CSS406	---
C 300 CDI 4-matic (W204)	OM 642.832	01.11 - 01.14	6	170	CSS406	CSS407
C 300 CDI 4-matic (W204)	OM 642.832	01.11 - 01.14	6	170	CSS405	---
C 32 AMG Kompressor (CL203)	M 112.961	05.02 - 06.11	6	260	CSS400	CSS402
C 32 AMG Kompressor (W203)	M 112.961	02.01 - 02.07	6	260	CSS400	CSS402
C 320 (W203)	M 112.946	05.00 - 02.07	6	160	CSS400	CSS402
C 320 CDI (W203)	OM 642.910	01.05 - 02.07	6	165	---	CSS407
C 320 CDI (W204)	OM 642.960	01.07 - 01.14	6	165	---	CSS407
C 320 CDI 4-matic (W204)	OM 642.961	07.07 - 01.14	6	165	---	CSS407
C 350 (W203)	M 272.960	01.05 - 02.07	4	200	CSS405	CSS403
C 350 (W204)	M 272.961	01.07 - 01.14	6	200	CSS405	CSS403
C 350 (W204)	M 272.961	01.11 - 01.14	6	225	---	CSS402
C 350 (W204)	M 272.982	09.08 - 01.14	6	215	---	CSS403
C 350 (W204)	M 276.957	01.11 - 01.14	6	225	CSS406	---
C 350 4-matic (W203)	M 272.960, M 272.970	01.05 - 02.07	6	200	CSS405	---
C 350 4-matic (W204)	M 276.957	01.11 - 01.14	6	225	CSS406	---
C 350 CDI (W204)	OM 642.830	10.09 - 01.14	6	170	CSS406	CSS407
C 350 CDI (W204)	OM 642.834	06.11 - 01.14	6	195	CSS406	CSS407
C 350 CDI (W204)	OM 642.834	06.11 - 01.14	6	195	CSS405	---
C 350 CDI (W204)	OM 642.960	07.09 - 01.14	6	165	---	CSS407
C 350 CDI 4-matic (W204)	OM 642.832	10.09 - 01.14	6	170	CSS406	CSS407
C 350 CDI 4-matic (W204)	OM 642.832	10.09 - 01.14	6	170	CSS405	---
C 350 CDI 4-matic (W204)	OM 642.961	07.09 - 01.14	6	165	---	CSS407
C 350 CGI (W204)	M 272.982	09.08 - 01.14	6	215	CSS405	CSS402
C 350 Coupe (C204)	M 276.957	06.11 ->	6	225	CSS406	---
C 350 Sportcoupe (CL203)	M 272.960	01.05 - 05.08	6	200	CSS405	---
C 36 AMG (W202)	M 104.941 (AMG 3.6)	05.94 - 05.00	6	206	---	CSS404
C 400 4-matic (W205)	M 276.823	10.14 ->	6	245	CSS406	---

Typ Type	Motornummer Engine-No.	Baujahr Year	Zyl. Cyl.	KW	Kurbelwellen- sensor Crankshaft S.	Nocken- wellensensor Camshaft S.
C 400 4-matic Cabriolet (A205)	M 276.823	06.16 ->	6	245	CSS406	---
C 400 4-matic Coupe (C205)	M 276.823	04.16 ->	6	245	CSS406	---
C 43 AMG (W202)	M 113.944	08.97 - 05.00	8	225	CSS400	CSS402
C 43 AMG 4-matic (C205)	M 276.823	04.16 ->	6	270	CSS406	---
C 43 AMG 4-matic (W205)	M 276.823	04.16 ->	6	270	CSS406	---
C 43 AMG 4-matic Cabriolet (A205)	M 276.823	10.16 ->	6	270	CSS406	---
C 450 AMG 4-matic (W205)	M 276.823	04.15 - 04.16	6	270	CSS406	---
C 63 AMG (W205)	M 177.980	10.14 ->	8	350	CSS406	---
C 63 AMG (W204)	M 156.985	02.08 - 01.14	8	336	CSS405	---
C 63 AMG (W204)	M 156.985	02.08 - 01.14	8	358	CSS405	---
C 63 AMG (W204)	M 156.985	02.08 - 01.14	8	373	CSS405	---
C 63 AMG Coupe (C204)	M 156.985	06.11 ->	8	336	CSS405	---
C 63 AMG Coupe (C204)	M 156.985	01.12 ->	8	358	CSS405	---
C 63 AMG Coupe (C204)	M 156.985	11.12 ->	8	373	CSS405	---
C 63 AMG Coupe (C204)	M 156.985	01.12 ->	8	380	CSS405	---
C 63 S AMG (W205)	M 177.980	10.14 ->	8	375	CSS406	---
C 63 S AMG Coupe (C205)	M 177.980	02.16 ->	8	375	CSS406	---
Citan 108 CDI (415)	OM 607.951	11.12 ->	4	55	CSS1537	---
Citan 109 CDI (415)	OM 607.951	11.12 ->	4	66	CSS1537	---
Citan 112 (415)	M 200.711	06.13 ->	4	84	CSS1537	---
Citan Mixto 109 CDI (415)	OM 607.951	11.12 ->	4	66	CSS1537	---
Citan Mixto 111 CDI (415)	OM 607.951	06.13 ->	4	81	CSS1537	---
Citan111 CDI (415)	OM 607.951	06.13 ->	4	81	CSS1537	---
CL 500 (C216)	M 278.920	02.11 - 12.13	8	320	CSS406	---
CL 500 4-matic (C216)	M 278.920	02.11 - 12.13	8	320	CSS406	---
CL 500 4-matic Coupe (C216)	M 273.968	02.08 - 12.13	8	285	CSS405	---
CL 500 Coupe (C216)	M 273.961	06.06 - 12.13	8	285	CSS405	---
CL 63 AMG (C216)	M 157.980	02.11 - 12.13	8	400	CSS406	---
CL 63 AMG Coupe (C216)	M 156.984	10.06 - 12.13	8	386	CSS405	---
CL 63 AMG Coupe (C216)	M 157.980	01.10 - 12.13	8	420	CSS406	---
CLA 180 CDI / d Coupe (C117)	OM 607.951	10.13 ->	4	80	CSS1537	---
CLA 180 d Shooting Brake (X117)	OM 607.951	07.15 ->	4	80	CSS1537	---
CLA 200 CDI Coupe (C117)	OM 651.901	06.13 ->	4	100	CSS406	---
CLA 200 CDI/d 4-matic Coupe (C117)	OM 651.930	07.14 ->	4	100	CSS406	---
CLA 200 CDI/d 4-matic Shooting Brake (X117)	OM 651.930	01.15 ->	4	100	CSS406	---
CLA 200 CDI/d Coupe (C117)	OM 651.930	07.14 ->	4	100	CSS406	---
CLA 200 CDI/d Shooting Brake (X117)	OM 651.930	01.15 ->	4	100	CSS406	---
CLA 220 CDI (C117)	OM 651.930	01.13 ->	4	125	CSS406	---
CLA 220 CDI 4-matic Coupe (C117)	OM 651.930	07.14 ->	4	125	CSS406	---
CLA 220 CDI/d 4-matic (C117)	OM 651.930	08.14 ->	4	120	CSS406	---
CLA 220 CDI/d 4-matic Coupe (C117)	OM 651.930	09.14 ->	4	130	CSS406	---
CLA 220 CDI/d 4-matic Shooting Brake (X117)	OM 651.930	01.15 ->	4	130	CSS406	---
CLA 220 CDI/d Coupe (C117)	OM 651.930	01.13 ->	4	120	CSS406	---
CLA 220 CDI/d Coupe (C117)	OM 651.930	09.14 ->	4	130	CSS406	---
CLA 220 CDI/d Shooting Brake (X117)	OM 651.930	01.15 ->	4	130	CSS406	---
CLA 220 CDI/d Shooting Brake (X117)	OM 651.930	01.15 ->	4	120	CSS406	---
CLA 220 CDI/d Shooting Brake (X117)	OM 651.930	09.15 ->	4	120	CSS406	---
CLC 160 (203.731)	M 271.911	02.09 - 06.11	4	95	CSS400	CSS403
CLC 180 Kompressor (CL203)	M 271.946	05.08 - 06.11	4	105	---	CSS403
CLC 200 CDI (CL203)	OM 646.962	05.08 - 06.11	4	90	---	CSS407
CLC 200 Kompressor (CL203)	M 272.955	05.08 - 06.11	4	135	---	CSS403
CLC 220 CDI (CL203)	OM 646.963	05.08 - 06.11	4	110	---	CSS407
CLC 230 (CL203)	M 272.920	05.08 - 06.11	6	150	CSS405	CSS402
CLC 230 Kompressor (CL203)	M 272.920	05.08 - 06.11	4	150	---	CSS403
CLC 350 (CL203)	M 272.960	05.08 - 06.11	6	200	CSS405	CSS402
CLC 350 Kompressor (CL203)	M 272.960	05.08 - 06.11	6	200	---	CSS403
CLK 200 (C208)	M 111.941, M 111.945	06.97 - 06.02	4	100	CSS401	CSS404
CLK 200 CGI (C208)	M 271.942	07.03 - 05.09	4	125	CSS400	CSS402
CLK 200 Kompressor (C208)	M 111.941, M 111.945	06.97 - 06.00	4	141	CSS401	CSS404

Typ Type	Motornummer Engine-No.	Baujahr Year	Zyl. Cyl.	KW	Kurbelwellen- sensor Crankshaft S.	Nocken- wellensensor Camshaft S.
CLK 200 Kompressor (C209)	M 271.940	09.02 - 05.09	4	120	CSS400	CSS402
CLK 200 Kompressor (C209)	M 271.955	10.06 - 05.09	4	135	---	CSS403
CLK 220 CDI (C209)	OM 646.966	01.05 - 05.09	4	110	---	CSS407
CLK 220 CDI (C209)	OM 646.966	01.05 - 05.09	4	100	---	CSS407
CLK 230 Kompressor (C208)	M 111.973, M 111.975	06.97 - 06.00	4	142	CSS401	CSS404
CLK 240 (C209)	M 112.912	06.02 - 05.09	6	125	CSS400	CSS402
CLK 270 CDI (C209)	OM 612.962, OM 612.967	10.02 - 05.09	5	125	---	CSS407
CLK 270 CDI (C209)	OM 612.967	02.03 - 06.05	5	120	---	CSS407
CLK 280 (C209)	M 112.940	01.05 - 05.09	6	170	---	CSS403
CLK 280 (C209)	M 272.940	01.05 - 05.09	6	170	CSS405	---
CLK 280 Cabriolet (A209)	M 272.940	01.05 - 03.10	6	170	CSS405	---
CLK 320 (C208)	M 112.940	06.97 - 06.02	6	160	CSS400	CSS402
CLK 320 (C209)	M 112.955	06.02 - 05.09	6	160	---	CSS402
CLK 320 CDI (C209)	OM 642.910	01.05 - 05.09	6	165	---	CSS407
CLK 320 CDI Cabriolet (A209)	OM 642.910	03.05 - 03.10	6	165	---	CSS407
CLK 350 (C209)	M 272.960	01.05 - 05.09	6	200	CSS405	CSS403
CLK 350 Cabriolet (A209)	M 272.960	01.05 - 03.10	6	200	CSS405	---
CLK 430 (C208)	M 113.943	07.98 - 06.02	8	205	CSS400	CSS402
CLK 500 (C209)	M 113. 968	06.02 - 05.09	8	225	---	CSS402
CLK 500 (C209)	M 273.965	06.06 - 05.09	8	285	CSS405	CSS403
CLK 500 Cabriolet (A209)	M 273.967	06.06 - 03.10	8	285	CSS405	---
CLK 55 AMG (C208)	M 113.984	08.99 - 06.02	8	255	CSS400	CSS402
CLK 55 AMG (C209)	M 113.987	09.02 - 05.09	8	270	CSS400	CSS402
CLK Cabriolet 200 (A208)	M 111.945, M 111.941	03.98 - 03.02	4	100	---	CSS404
CLK Cabriolet 200 Kompressor (A208)	M 111.944	03.98 - 06.00	4	141	---	CSS404
CLK Cabriolet 230 Kompressor (A208)	M 111.975, M 111.973	03.98 - 06.00	4	142	---	CSS404
CLK DTM AMG (C209)	M 113.944	06.04 - 05.09	8	428	---	CSS402
CLS 220 BlueTEC (C218)	OM 651.924	05.14 ->	4	130	CSS406	---
CLS 220 BlueTEC Shooting Brake (X218)	OM 651.924	05.14 ->	4	130	CSS406	---
CLS 220 BlueTEC/d (C218)	OM 651.924	05.14 ->	4	120	CSS406	---
CLS 220 BlueTEC/d (C218)	OM 651.924	05.14 ->	4	125	CSS406	---
CLS 220 BlueTEC/d Shooting Brake (X218)	OM 651.924	05.14 ->	4	120	CSS406	---
CLS 250 BlueTEC/d 4-matic (C218)	OM 651.924	05.14 ->	4	150	CSS406	---
CLS 250 BlueTEC/d Shooting Brake (X218)	OM 651.924	05.14 ->	4	150	CSS406	---
CLS 250 CDI Shooting Brake (X218)	OM 651.924	10.12 ->	4	150	CSS400	---
CLS 250 CDI/BlueTEC/d (C218)	OM 651.924	04.11 ->	4	150	CSS406	---
CLS 250 CDI/BlueTEC/d Shooting Brake (X218)	OM 651.924	10.12 ->	4	150	CSS406	---
CLS 280 (C219)	M 272.943	07.08 - 12.10	6	170	CSS405	CSS403
CLS 300 (C219)	M 272.943	04.09 - 12.10	6	170	CSS405	CSS403
CLS 320 CDI (C219)	OM 642.920	01.05 - 12.10	6	165	---	CSS407
CLS 320 CDI (C219)	OM 642.920	01.05 - 12.10	6	155	---	CSS407
CLS 350 (C219)	M 272.964	10.04 - 12.10	6	200	CSS405	CSS403
CLS 350 (C219)	M 272.985	04.06 - 12.10	6	215	CSS405	CSS403
CLS 350 BlueTEC (C218)	OM 642.852	11.12 ->	6	185	CSS406	---
CLS 350 BlueTEC (C218)	OM 642.852	11.12 ->	6	185	CSS405	---
CLS 350 BlueTEC / d (C218)	OM 642.853	06.14 ->	6	190	CSS405	---
CLS 350 BlueTEC / d Shooting Brake (X218)	OM 642.853	05.14 ->	6	190	CSS405	---
CLS 350 BlueTEC 4-matic (C218)	OM 642.858	11.12 ->	6	185	CSS406	---
CLS 350 BlueTEC 4-matic (C218)	OM 642.858	11.12 ->	6	185	CSS405	---
CLS 350 BlueTEC 4-matic Shooting Brake (X218)	OM 642.858	05.14 ->	6	185	CSS406	---
CLS 350 BlueTEC 4-matic Shooting Brake (X218)	OM 642.858	05.14 ->	6	185	CSS405	---
CLS 350 BlueTEC/d (C218)	OM 642.853, OM 642.852	06.14 ->	6	190	CSS406	---
CLS 350 BlueTEC/d Shooting Brake (X218)	OM 642.853, OM 642.852	05.14 ->	6	190	CSS406	---
CLS 350 CDI (C218)	OM 642.853	01.11 ->	6	195	CSS406	CSS407
CLS 350 CDI (C218)	OM 642.853	01.11 ->	6	195	CSS405	---
CLS 350 CDI (C219)	OM 642.920	04.09 - 12.10	6	165	---	CSS407
CLS 350 CDI 4-matic (C218)	OM 642.854	09.11 ->	6	195	CSS406	CSS407
CLS 350 CDI 4-matic (C218)	OM 642.854	09.11 ->	6	195	CSS405	---
CLS 350 CDI 4-matic Shooting Brake (X218)	OM 642.854	10.12 ->	6	195	CSS406	CSS407

Typ Type	Motornummer Engine-No.	Baujahr Year	Zyl. Cyl.	KW	Kurbelwellen- sensor Crankshaft S.	Nocken- wellensensor Camshaft S.
CLS 350 CDI 4-matic Shooting Brake (X218)	OM 642.854	10.12 ->	6	195	CSS405	---
CLS 350 CDI Shooting Brake (X218)	OM 642.853	10.12 ->	6	195	CSS406	CSS407
CLS 350 CDI Shooting Brake (X218)	OM 642.853	10.12 ->	6	195	CSS405	---
CLS 350 CGI (C219)	M 272.985	04.09 - 12.10	6	215	CSS405	CSS403
CLS 350 d 4-matic (C218)	OM 642.858, OM 642.854	04.15 ->	6	190	CSS406	---
CLS 350 d 4-matic (C218)	OM 642.858, OM 642.854	04.15 ->	6	190	CSS405	---
CLS 350 d 4-matic Shooting Brake (X218)	OM 642.858, OM 642.854	04.15 ->	6	190	CSS406	---
CLS 350 d 4-matic Shooting Brake (X218)	OM 642.858, OM 642.854	04.15 ->	6	190	CSS405	---
CLS 400 (C218)	M 276.820	05.14 ->	6	245	CSS406	---
CLS 400 (C218)	M 276.850	07.14 ->	6	245	CSS406	---
CLS 400 4-matic (C218)	M 276.820	05.14 ->	6	245	CSS406	---
CLS 400 4-matic (C218)	M 276.850	07.14 ->	6	245	CSS406	---
CLS 400 4-matic Shooting Brake (X218)	M 276.820	05.14 ->	6	245	CSS406	---
CLS 400 4-matic Shooting Brake (X218)	M 276.850	07.14 ->	6	245	CSS406	---
CLS 400 Shooting Brake (X218)	M 276.820	05.14 ->	6	245	CSS406	---
CLS 400 Shooting Brake (X218)	M 276.850	07.14 ->	6	245	CSS406	---
CLS 500 (C218)	M 278.922	02.11 ->	8	300	CSS406	---
CLS 500 (C219)	M 113.967	10.04 - 12.10	8	225	CSS400	CSS402
CLS 500 (C219)	M 273.960	04.06 - 12.10	8	285	CSS405	CSS403
CLS 500 4-matic (C218)	M 278.922	09.11 ->	8	300	CSS406	---
CLS 500 4-matic Shooting Brake (X218)	M 278.922	10.12 ->	8	300	CSS406	---
CLS 500 Shooting Brake (X218)	M 278.922	10.12 ->	8	300	CSS406	---
CLS 55 AMG (C219)	M 113.990	01.05 - 12.10	8	350	CSS400	CSS402
CLS 63 AMG (C218)	M 157.980, M 157.981	01.11 ->	8	410	CSS406	---
CLS 63 AMG (C218)	M 157.981	02.11 ->	8	386	CSS406	---
CLS 63 AMG (C218)	M 157.981	02.13 ->	8	430	CSS406	---
CLS 63 AMG (C219)	M 156.983	04.06 - 12.10	8	378	CSS405	CSS403
CLS 63 AMG 4-matic (C218)	M 157.981	05.13 ->	8	410	CSS406	---
CLS 63 AMG 4-matic (C218)	M 157.981	02.13 ->	8	430	CSS406	---
CLS 63 AMG 4-matic Shooting Brake (X218)	M 157.981	05.13 ->	8	410	CSS406	---
CLS 63 AMG 4-matic Shooting Brake (X218)	M 157.981	02.13 ->	8	430	CSS406	---
CLS 63 AMG Shooting Brake (X218)	M 157.981	10.12 ->	8	386	CSS406	---
CLS 63 AMG Shooting Brake (X218)	M 157.981	05.13 ->	8	410	CSS406	---
CLS 63 AMG Shooting Brake (X218)	M 157.981	02.13 ->	8	430	CSS406	---
E 200 (W210)	M 111.942	06.95 - 08.00	4	100	CSS401	CSS404
E 200 CDI (W210)	OM 611.961	06.98 - 03.02	4	75	---	CSS407
E 200 CDI (W210)	OM 611.961	07.99 - 03.02	4	85	---	CSS407
E 200 CDI (W210)	OM 611.961	07.99 - 03.02	4	85	CSS401	---
E 200 CDI (W210)	OM 611.961	06.98 - 03.02	4	75	CSS401	---
E 200 CDI (W211)	OM 646.820	04.06 - 12.08	4	100	---	CSS407
E 200 CDI (W211)	OM 646.951	07.02 - 12.08	4	90	---	CSS407
E 200 CDI/BlueTEC (W212)	OM 651.925	01.09 ->	4	100	CSS406	---
E 200 CGI (W211)	M 271.820, M271.860	08.09 ->	4	135	---	CSS403
E 200 CGI (W211)	M 271.946	11.02 - 12.08	4	125	---	CSS402
E 200 CGI (W212)	M 271.820, M 271.860	08.09 ->	4	135	CSS405	---
E 200 CGI Cabriolet (A207)	M 271.820, M 271.860	01.10 ->	4	135	CSS405	---
E 200 CGI Coupe (C207)	M 271.820, M 271.860	01.10 ->	4	135	CSS405	---
E 200 D (W210)	OM 604.917	01.96 - 03.02	4	88	CSS401	---
E 200 Kompressor (W210)	M 111.947	06.97 - 03.02	4	137	CSS401	---
E 200 Kompressor (W211)	M 271.941	11.02 - 12.08	4	120	---	CSS402
E 200 NGT (W211)	M 271.941	03.04 - 12.08	4	120	CSS400	CSS402
E 220 BlueTEC (W212)	OM 651.924	05.14 ->	4	130	CSS406	---
E 220 BlueTEC 4-matic (W212)	OM 651.924	01.15 ->	4	125	CSS406	---
E 220 BlueTEC Cabriolet (A207)	OM 651.911	05.14 ->	4	130	CSS406	---
E 220 BlueTEC Coupe (C207)	OM 651.911	05.14 ->	4	130	CSS406	---
E 220 CDI (W210)	OM 611.961	06.98 - 07.99	4	92	---	CSS407
E 220 CDI (W210)	OM 611.961	07.99 - 03.02	4	105	---	CSS407
E 220 CDI (W210)	OM 611.961	07.99 - 03.02	4	100	---	CSS407
E 220 CDI (W210)	OM 611.961	07.99 - 03.02	4	105	CSS401	---

Typ Type	Motornummer Engine-No.	Baujahr Year	Zyl. Cyl.	KW	Kurbelwellen- sensor Crankshaft S.	Nocken- wellensensor Camshaft S.
E 220 CDI (W210)	OM 611.961	06.98 - 07.99	4	92	CSS401	---
E 220 CDI (W211)	OM 646.821	03.03 - 12.08	4	120	---	CSS407
E 220 CDI (W211)	OM 646.821	04.06 - 12.08	4	125	---	CSS407
E 220 CDI (W211)	OM 646.961	03.02 - 12.08	4	110	---	CSS407
E 220 CDI (W211)	OM 646.961	03.02 - 12.08	4	100	---	CSS407
E 220 CDI (W212)	OM 651.924	01.09 ->	4	120	CSS406	---
E 220 CDI Cabriolet (A207)	OM 651.911	02.10 ->	4	120	CSS406	---
E 220 CDI Coupe (C207)	OM 651.911	07.14 ->	4	120	CSS406	---
E 220 CDI/BlueTEC (W212)	OM 651.924	01.09 ->	4	125	CSS406	---
E 220 CDI/BlueTEC /d Cabriolet (A207)	OM 651.911	01.10 ->	4	125	CSS406	---
E 220 CDI/d Coupe (C207)	OM 651.911	01.10 ->	4	125	CSS406	---
E 220 d (W210)	OM 604.912	05.96 - 03.02	4	55	CSS401	---
E 220 d (W210)	OM 604.912	06.95 - 07.99	4	70	CSS401	---
E 230 (W210)	M 111.970	06.95 - 06.97	4	110	CSS401	CSS404
E 230 (W211)	M 272.922	09.07 - 12.08	6	150	CSS405	---
E 240 (W210)	M 112.911	06.97 - 08.00	6	125	---	CSS402
E 240 (W210)	M 112.914	08.00 - 03.02	6	125	CSS400	CSS402
E 240 (W211)	M 112.913, M 112.917	03.02 - 12.08	6	130	CSS400	CSS402
E 250 BlueTEC (W212)	OM 642.850	01.09 ->	6	155	CSS406	CSS407
E 250 CDI/BlueTEC (W212)	OM 651.924	01.09 ->	4	150	CSS406	---
E 250 CDI/BlueTEC 4-matic (W212)	OM 651.924	01.09 ->	4	150	CSS406	---
E 250 CDI/BlueTEC/d Cabriolet (A207)	OM 651.911	01.10 ->	4	150	CSS406	---
E 250 CDI/d Coupe (C207)	OM 651.911	01.09 ->	4	150	CSS406	---
E 250 CGI (W212)	M 271.860	01.09 ->	4	150	CSS405	CSS403
E 250 CGI Cabriolet (A207)	M 271.860	01.10 ->	4	150	CSS405	---
E 250 CGI Coupe (C207)	M 271.860	01.09 ->	4	150	CSS405	---
E 250 D (W210)	OM 605.912	06.95 - 07.99	4	83	CSS401	---
E 250 Turbo D (W210)	OM 605.962	06.97 - 07.99	5	110	CSS401	---
E 270 CDI (W210)	OM 612.961	07.99 - 03.02	5	120	---	CSS407
E 270 CDI (W210)	OM 612.961	07.99 - 03.02	5	125	---	CSS407
E 270 CDI (W211)	OM 647.961	03.02 - 12.08	5	130	---	CSS407
E 270 CDI (W211)	OM 647.961	03.02 - 12.08	5	120	---	CSS407
E 280 (W210)	M 104.945	01.96 - 06.97	6	142	---	CSS404
E 280 (W210)	M 112.921	12.96 - 03.02	6	150	---	CSS402
E 280 (W211)	M 272.943	03.05 - 12.08	6	170	CSS405	---
E 280 4-matic (W211)	M 272.943	01.06 - 12.08	6	170	CSS405	---
E 280 CDI (W211)	OM 642.920	03.05 - 12.08	6	140	---	CSS407
E 280 CDI (W211)	OM 648.961	05.04 - 12.08	6	130	---	CSS407
E 280 CDI 4-matic (W211)	OM 642.921	03.05 - 12.08	6	140	---	CSS407
E 290 Turbo D (W210)	OM 602.982	03.96 - 07.99	5	95	CSS401	---
E 300 (W212)	M 272.952	01.09 ->	6	170	CSS405	CSS403
E 300 BlueTEC (W211)	OM 642.920	09.07 - 12.08	6	155	---	CSS407
E 300 Cabriolet (A207)	M 276.957	04.11 ->	6	185	CSS406	---
E 300 CDI (W212)	OM 642.850	12.09 - 12.10	6	150	CSS406	CSS407
E 300 CDI / BlueTEC (W212)	OM 642.850, OM 642.852	03.11 ->	6	170	CSS405	---
E 300 CDI(W212)	OM 642.850	12.09 - 12.10	6	150	CSS405	---
E 300 CDI/BlueTEC (W212)	OM 642.850, OM 642.852	03.11 ->	6	170	CSS406	CSS407
E 300 Coupe (E300)	M 276.957	04.11 ->	6	185	CSS406	---
E 300 D (W210)	OM 606.912	06.95 - 06.97	4	100	CSS401	---
E 300 Hybrid/BlueTEC Hybrid (W212)	OM 651.924	12.11 ->	4	150	CSS406	---
E 300 Turbo D (W210)	OM 606.962	12.96 - 07.99	4	130	CSS401	---
E 320 (W210)	M 112.941	06.97 - 03.02	6	165	CSS400	CSS402
E 320 (W211)	M 112.949	03.02 - 12.08	6	165	CSS400	CSS402
E 320 Cabriolet (A207)	M 276.820	07.14 ->	6	200	CSS406	---
E 320 CDI (W210)	OM 613.961	07.99 - 03.02	6	145	---	CSS407
E 320 CDI (W211)	OM 642.920	03.05 - 12.08	6	165	---	CSS407
E 320 CDI (W211)	OM 648.961	11.02 - 12.08	6	150	---	CSS407
E 320 Coupe (C207)	M 276.820	07.14 ->	6	200	CSS406	---
E 350 (W211)	M 272.964	03.05 - 12.08	6	200	CSS405	---

Typ Type	Motornummer Engine-No.	Baujahr Year	Zyl. Cyl.	KW	Kurbelwellen- sensor Crankshaft S.	Nocken- wellensensor Camshaft S.
E 350 (W212)	M 272.980	01.09 ->	6	200	CSS405	---
E 350 4-matic (W211)	M 272.972	03.05 - 12.08	6	200	CSS405	---
E 350 4-matic (W212)	M 272.977	01.09 - 08.11	6	200	CSS405	---
E 350 4-matic Coupe (C207)	M 276.957	02.13 ->	6	225	CSS406	---
E 350 BlueTEC (W212)	OM 642.850	01.09 ->	6	155	CSS405	---
E 350 BlueTEC (W212)	OM 642.852	11.12 ->	6	185	CSS406	CSS407
E 350 BlueTEC (W212)	OM 642.852	05.14 ->	6	190	CSS406	---
E 350 BlueTEC (W212)	OM 642.852	11.12 ->	6	185	CSS405	---
E 350 BlueTEC (W212)	OM 642.852	05.14 ->	6	190	CSS405	---
E 350 BlueTEC / d Coupe (C207)	OM 642.838	05.14 ->	6	190	CSS405	---
E 350 BlueTEC 4-matic (W212)	OM 642.858	11.12 ->	6	185	CSS406	CSS407
E 350 BlueTEC 4-matic (W212)	OM 642.858	05.14 ->	6	190	CSS406	---
E 350 BlueTEC 4-matic (W212)	OM 642.858	11.12 ->	6	185	CSS405	---
E 350 BlueTEC 4-matic (W212)	OM 642.858	05.14 ->	6	190	CSS405	---
E 350 BlueTEC Cabriolet (A207)	OM 642.838	06.13 ->	6	185	CSS406	CSS407
E 350 BlueTEC Cabriolet (A207)	OM 642.838	06.13 ->	6	185	CSS405	---
E 350 BlueTEC Coupe (C207)	OM 642.838	03.13 ->	6	185	CSS406	CSS407
E 350 BlueTEC Coupe (C207)	OM 642.838	03.13 ->	6	185	CSS405	---
E 350 BlueTEC/ d Cabriolet (A207)	OM 642.838	05.14 ->	6	190	CSS405	---
E 350 BlueTEC/d Cabriolet (A207)	OM 642.838	05.14 ->	6	190	CSS406	---
E 350 BlueTEC/d Coupe (C207)	OM 642.838	05.14 ->	6	190	CSS406	---
E 350 Cabriolet (A207)	M 276.957	04.11 ->	6	225	CSS406	---
E 350 CDI (W212)	OM 642.850	01.09 ->	6	170	CSS406	CSS407
E 350 CDI (W212)	OM 642.850	01.09 ->	6	170	CSS405	---
E 350 CDI (W212)	OM 642.852	03.11 ->	6	195	CSS406	CSS407
E 350 CDI (W212)	OM 642.852	03.11 ->	6	195	CSS405	---
E 350 CDI 4-matic (W212)	OM 642.856	09.09 ->	6	170	CSS406	CSS407
E 350 CDI 4-matic (W212)	OM 642.856	09.09 ->	6	170	CSS405	---
E 350 CDI 4-matic (W212)	OM 642.858	03.11 ->	6	195	CSS406	CSS407
E 350 CDI 4-matic (W212)	OM 642.858	03.11 ->	6	195	CSS405	---
E 350 CDI Cabriolet (A207)	OM 642.836	01.10 ->	6	170	CSS406	CSS407
E 350 CDI Cabriolet (A207)	OM 642.836	01.10 ->	6	170	CSS405	---
E 350 CDI Cabriolet (A207)	OM 642.838	04.11 ->	6	195	CSS406	CSS407
E 350 CDI Cabriolet (A207)	OM 642.838	04.11 ->	6	195	CSS405	---
E 350 CDI Coupe (C207)	OM 642.836	01.09 ->	6	170	CSS406	CSS407
E 350 CDI Coupe (C207)	OM 642.836	01.09 ->	6	170	CSS405	---
E 350 CDI Coupe (C207)	OM 642.838	04.11 ->	6	195	CSS406	CSS407
E 350 CDI Coupe (C207)	OM 642.838	04.11 ->	6	195	CSS405	---
E 350 CGI (W212)	M 272.983, M 272.982	01.09 - 08.11	6	215	CSS405	CSS403
E 350 CGI Cabriolet (A207)	M 272.982, M 272.984	01.10 ->	6	215	CSS405	---
E 350 CGI Coupe (C207)	M 272.982, M 272.984	01.09 ->	6	215	CSS405	---
E 350 Coupe (C207)	M 272.988	05.11 ->	6	200	CSS405	---
E 350 Coupe (C207)	M 276.957	04.11 ->	6	225	CSS406	---
E 350 d (W213)	OM 642.855	01.16 ->	6	190	CSS406	---
E 400 (W212)	M 276.820	01.13 ->	6	245	CSS406	---
E 400 (W212)	M 276.850	07.14 ->	6	245	CSS406	---
E 400 4-matic (W212)	M 276.820	01.13 ->	6	245	CSS406	---
E 400 4-matic (W212)	M 276.850	07.14 ->	6	245	CSS406	---
E 400 4-matic (W213)	M 276.823	06.16 ->	6	245	CSS406	---
E 400 4-matic (W213)	M 276.853	07.16 ->	6	245	CSS406	---
E 400 Cabriolet (A207)	M 276.820	06.13 ->	6	245	CSS406	---
E 400 Cabriolet (A207)	M 276.850	07.14 ->	6	245	CSS406	---
E 400 CDI (W211)	OM 628.961	02.03 - 12.08	8	191	---	CSS407
E 400 Coupe (C207)	M 276.820	06.13 ->	6	245	CSS406	---
E 400 Coupe (C207)	M 276.850	07.14 ->	6	245	CSS406	---
E 420 (W210)	M 119.985	01.96 - 06.97	8	205	---	CSS402
E 420 (W210)	M 119.985	01.96 - 06.97	8	205	CSS401	---
E 420 CDI (W211)	OM 629.910	01.06 - 12.08	8	231	CSS405	---
E 43 AMG 4-matic (W213)	M 276.823	07.16 ->	6	295	CSS406	---

Typ Type	Motornummer Engine-No.	Baujahr Year	Zyl. Cyl.	KW	Kurbelwellen- sensor Crankshaft S.	Nocken- wellensensor Camshaft S.
E 430 (W210)	M 113.945	06.97 - 03.02	8	205	CSS400	CSS402
E 50 AMG (W210)	M 119.985	02.96 - 08.97	8	255	CSS401	---
E 500 (W211)	M 113.967	03.02 - 12.08	8	225	CSS400	CSS402
E 500 (W211)	M 273.960	04.06 - 12.08	8	285	CSS405	---
E 500 (W212)	M 273.971	01.09 ->	8	285	CSS405	CSS403
E 500 (W212)	M 278.922	09.11 ->	8	300	CSS406	---
E 500 4-matic (W211)	M 273.962	04.06 - 12.08	8	285	CSS405	---
E 500 4-matic (W212)	M 273.970	01.09 ->	8	285	CSS405	---
E 500 4-matic (W212)	M 278.922	09.11 ->	8	300	CSS406	---
E 500 Cabriolet (A207)	M 278.922	09.11 ->	8	300	CSS406	---
E 500 Coupe (C207)	M 278.922	09.11 ->	8	300	CSS406	---
E 55 AMG (W210)	M 113.980	08.97 - 03.02	8	260	CSS400	CSS402
E 55 AMG Kompressor (W211)	M 113.990	10.02 - 12.08	8	350	CSS400	CSS402
E 63 AMG (W211)	M 156.983	03.06 - 12.08	8	378	CSS405	CSS403
E 63 AMG (W212)	M 156.985	12.09 ->	8	386	CSS405	---
E 63 AMG (W212)	M 157.980, M 157.981	02.11 ->	8	386	CSS406	---
E 63 AMG (W212)	M 157.981	02.11 ->	8	410	CSS406	---
E 63 AMG (W212)	M 157.981	02.13 ->	8	430	CSS406	---
E 63 AMG 4-matic (W212)	M 157.981	02.13 ->	8	430	CSS406	---
E 63 AMG 4-matic (W212)	M 157.981	02.11 ->	8	410	CSS406	---
G 270 CDI (W461)	OM 612.966	01.03 ->	5	115	---	CSS407
G 270 CDI (W463)	OM 612.965	10.01 ->	5	115	---	CSS407
G 280 CDI (W461)	OM 642.884	04.09 ->	6	135	CSS406	---
G 300 CDI (W461)	OM 642.884	04.10 ->	6	135	CSS406	CSS407
G 320 (W463)	M 104.996	09.94 - 12.97	6	155	---	CSS404
G 320 (W463)	M 112.945	07.97 ->	6	158	CSS400	CSS402
G 320 CDI (W463)	OM 642.970	09.06 ->	6	165	---	CSS407
G 320 CDI Cabrio (W463)	OM 642.970	09.06 ->	6	165	---	CSS407
G 320 GE (W463)	M 104.996	09.94 - 11.97	6	155	---	CSS404
G 350 CDI (W463)	OM 642.886	07.11 ->	6	155	CSS406	CSS407
G 350 CDI (W463)	OM 642.886	07.11 ->	6	155	CSS405	---
G 350 d (W463)	OM 642.887	06.15 ->	6	180	CSS406	---
G 400 CDI (W463)	OM 628.962	12.00 ->	8	184	---	CSS407
G 400 CDI (W463)	OM 628.962	12.00 ->	8	184	---	CSS407
G 500 (W463)	M 113.962	04.98 ->	8	218	CSS400	CSS402
G 500 (W463)	M 176.980	06.15 ->	8	310	CSS406	---
G 500 (W463)	M 273.963	12.09 ->	8	285	CSS405	CSS403
G 55 AMG (W463)	M 113.993	06.04 ->	8	350	CSS400	CSS402
G 63 AMG (W463)	M 157.984	05.12 ->	8	400	CSS406	---
G 63 AMG (W463)	M 157.984	06.15 ->	8	420	CSS406	---
G 63 AMG 6x6 (W463)	M 157.984	12.14 ->	8	400	CSS406	---
G 65 AMG (W463)	M 279.982	05.12 ->	12	450	CSS406	---
G 65 AMG (W463)	M 279.982	06.15 ->	12	463	CSS406	---
G 65 AMG (W463)	M 279.982	06.15 ->	12	463	---	CSS403
GL 320 CDI / 350 BlueTEC 4-matic (X164)	OM 642.820	12.09 ->	6	155	CSS405	---
GL 320 CDI 4-matic (X164)	OM 642.940	09.06 - 05.09	6	165	---	CSS407
GL 320 CDI/350 BlueTEC (X164)	OM 642.820	12.09 ->	6	155	CSS406	CSS407
GL 350 CDI 4-matic (X164)	OM 642.822	10.10 ->	6	195	CSS406	CSS407
GL 350 CDI 4-matic (X164)	OM 642.822	10.10 ->	6	195	CSS405	---
GL 350 CDI 4-matic (X164)	OM 642.940	05.09 ->	6	165	---	CSS407
GL 350 CDI/BlueTEC 4-matic (X166)	OM 642.826	07.12 ->	6	190	CSS406	CSS407
GL 400 4-matic (X166)	M 276.821	08.13 ->	6	245	CSS406	---
GL 420 CDI 4-matic (X164)	OM 629.912	09.06 - 05.09	8	225	CSS405	CSS403
GL 450 4-matic (X164)	M 273.923	09.06 ->	8	250	CSS405	CSS403
GL 450 CDI 4-matic (X164)	OM 629.912	05.09 ->	8	225	CSS405	CSS403
GL 500 4-matic (X164)	M 273.963	09.06 ->	8	285	CSS405	CSS403
GL 500 4-matic (X166)	M 278.928	07.12 ->	8	320	CSS406	---
GL 63 AMG 4-matic (X166)	M 157.982	07.12 ->	8	410	CSS406	---
GLA 180 CDI / d (X156)	OM 607.951	07.14 ->	4	80	CSS1537	---

Typ Type	Motornummer Engine-No.	Baujahr Year	Zyl. Cyl.	KW	Kurbelwellen- sensor Crankshaft S.	Nocken- wellensensor Camshaft S.
GLA 200 CDI 4-matic (X156)	OM 651.930	12.13 ->	4	100	CSS406	---
GLA 200 CDI/d (X156)	OM 651.930	12.13 ->	4	100	CSS406	---
GLA 220 CDI (X156)	OM 651.930	12.13 ->	4	125	CSS406	---
GLA 220 CDI 4-matic (X156)	OM 651.930	12.13 ->	4	125	CSS406	---
GLA 220 CDI/d (X156)	OM 651.930	12.13 ->	4	120	CSS406	---
GLA 220 CDI/d 4-matic (X156)	OM 651.930	12.13 ->	4	120	CSS406	---
GLA 220 d (X156)	OM 651.930	07.15 ->	4	130	CSS406	---
GLA 220 d 4-matic (X156)	OM 651.930	07.15 ->	4	130	CSS406	---
GLC 220 d 4-matic (X253)	OM 651.921	06.15 ->	4	125	CSS406	---
GLC 220 d 4-matic (X253)	OM 651.921	06.15 ->	4	120	CSS406	---
GLC 250 d 4-matic (X253)	OM 651.921	06.15 ->	4	150	CSS406	---
GLC 350 d 4-matic (X253)	OM 642.873	10.16 ->	6	190	CSS406	---
GLC 350 d 4-matic Coupe (C253)	OM 642.873	10.16 ->	6	190	CSS406	---
GLC 43 AMG 4-matic (X253)	M 276.823	04.16 ->	6	270	CSS406	---
GLE 250 d (W166)	OM 651.960	04.15 ->	4	150	CSS406	---
GLE 250 d 4-matic (W166)	OM 651.960	04.15 ->	4	150	CSS406	---
GLE 320 4-matic (W166)	M 276.821	10.15 ->	6	200	CSS406	---
GLE 350 d 4-matic (C292)	OM 642.826	03.15 ->	6	190	CSS406	---
GLE 350 d 4-matic (W166)	OM 642.826	04.15 ->	6	190	CSS406	---
GLE 400 4-matic (C292)	M 276.821, M 276.925	03.15 ->	6	245	CSS406	---
GLE 400 4-matic (W166)	M 276.821	04.15 ->	6	245	CSS406	---
GLE 450 AMG 4-matic (C292)	M 276.821	03.15 ->	6	270	CSS406	---
GLE 450 AMG 4-matic (W166)	M 276.821	10.15 - 04.16	6	270	CSS406	---
GLE 500 4-matic (W166)	M 278.928	04.15 ->	8	320	CSS406	---
GLE 500 4-matic (W166)	M 278.928	10.15 ->	8	335	CSS406	---
GLE 500 4-matic Coupe (C292)	M 278.928	10.15 ->	8	335	CSS406	---
GLE 500 e 4-matic (W166)	M 276.821	04.15 ->	6	245	CSS406	---
GLE 63 AMG 4-matic (C292)	M 157.982	03.15 ->	8	410	CSS406	---
GLE 63 AMG 4-matic (W166)	M 157.982	04.15 ->	8	410	CSS406	---
GLE 63 S AMG 4-matic (C292)	M 157.982	03.15 ->	8	430	CSS406	---
GLE 63 S AMG 4-matic (W166)	M 157.982	04.15 ->	8	430	CSS406	---
GLK 200 CDI (C204)	OM 651.916, OM 651.913	07.10 - 06.15	4	105	CSS406	---
GLK 200 CDI (X204)	OM 651.916	12.13 - 06.15	4	100	CSS406	---
GLK 220 CDI (X204)	OM 651.916	12.08 - 06.15	4	125	CSS406	---
GLK 220 CDI (X204)	OM 651.916	12.08 - 06.15	4	120	CSS406	---
GLK 220 CDI 4-matic (X204)	OM 651.912	12.08 - 06.15	4	125	CSS406	---
GLK 220 CDI 4-matic (X204)	OM 651.912	12.08 - 06.15	4	120	CSS406	---
GLK 220 d 4-matic (C253)	OM 651.921	06.16 ->	4	125	CSS406	---
GLK 250 CDI 4-matic (X204)	OM 651.912	09.09 - 06.15	4	150	CSS406	---
GLK 250 d 4-matic (C253)	OM 651.921	06.16 ->	4	150	CSS406	---
GLK 280 4-matic (X204)	M 272.948	06.08 - 06.09	6	170	CSS405	CSS403
GLK 300 4-matic (X204)	M 272.948	07.09 - 04.11	6	170	---	CSS403
GLK 300 4-matic (X204)	M 276.957	09.09 - 06.15	6	185	CSS406	---
GLK 320 CDI 4-matic (X204)	OM 642.961	06.08 - 06.15	6	165	---	CSS407
GLK 350 (X204)	M 272.991	04.09 ->	6	200	CSS405	CSS403
GLK 350 4-matic (X204)	M 272.971	06.08 - 04.11	6	200	CSS405	---
GLK 350 4-matic (X204)	M 276.957	06.08 - 06.15	6	225	CSS406	---
GLK 350 CDI 4-matic (X204)	OM 642.832	02.10 - 05.10	6	170	CSS406	CSS407
GLK 350 CDI 4-matic (X204)	OM 642.832	07.09 - 01.10	6	165	CSS406	CSS407
GLK 350 CDI 4-matic (X204)	OM 642.832	07.09 - 01.10	6	165	CSS405	---
GLK 350 CDI 4-matic (X204)	OM 642.832	02.10 - 05.10	6	170	CSS405	---
GLK 350 CDI 4-matic (X204)	OM 642.835	07.12 - 06.15	6	195	CSS406	CSS407
GLS 350 d 4-matic (X166)	OM 642.826	11.15 ->	6	190	CSS406	---
GLS 400 4-matic (X166)	M 276.821	11.15 ->	6	245	CSS406	---
GLS 500 4-matic (X166)	M 278.928	11.15 ->	8	335	CSS406	---
GLS 63 AMG 4-matic (X166)	M 157.982	11.15 ->	8	430	CSS406	---
GT AMG (C190)	M 178.980	08.15 ->	8	340	CSS406	---
GT S AMG (C190)	M 178.980	10.14 ->	8	375	CSS406	---
ML 230 (W163)	M 111.977	02.98 - 06.05	4	110	---	CSS404

Typ Type	Motornummer Engine-No.	Baujahr Year	Zyl. Cyl.	KW	Kurbelwellen- sensor Crankshaft S.	Nocken- wellensensor Camshaft S.
ML 250 CDI BlueTEC 4-matic (W166)	OM 651.960	06.11 ->	4	150	CSS400	---
ML 250 CDI/BlueTEC 4-matic (W166)	OM 651.960	06.11 ->	4	150	CSS406	---
ML 270 CDI (W163)	OM 612.963	12.99 - 06.05	5	120	---	CSS407
ML 280 CDI 4-matic (W164)	OM 642.940	07.05 - 07.09	6	140	---	CSS407
ML 300 4-matic (W166)	M 276.955	04.14 ->	6	185	CSS406	---
ML 300 CDI 4-matic (W164)	OM 642.820	02.10 - 12.11	6	150	CSS406	CSS407
ML 300 CDI 4-matic (W164)	OM 642.820	02.10 - 12.11	6	150	CSS405	---
ML 300 CDI 4-matic (W164)	OM 642.940	07.09 - 12.11	6	140	---	CSS407
ML 320 (W163)	M 112.942	02.98 - 08.02	6	160	---	CSS402
ML 320 CDI 4-matic (W164)	OM 642.940	07.05 - 07.09	6	165	---	CSS407
ML 350 (W163)	M 112.970	08.02 - 06.05	6	180	CSS400	CSS402
ML 350 4-matic (W164)	M 272.962, M 272.967	07.05 ->	6	200	CSS405	CSS403
ML 350 4-matic (W166)	M 276.955	06.11 ->	6	225	CSS406	---
ML 350 BlueTEC 4-matic (W166)	OM 642.826	06.11 ->	6	190	CSS406	CSS407
ML 350 CDI 4-matic (W164)	OM 642.820	09.09 - 12.11	6	155	CSS406	CSS407
ML 350 CDI 4-matic (W164)	OM 642.820	02.10 - 12.11	6	170	CSS406	---
ML 350 CDI 4-matic (W164)	OM 642.820	09.09 - 12.11	6	155	CSS405	---
ML 350 CDI 4-matic (W164)	OM 642.820	02.10 - 12.11	6	170	CSS405	---
ML 350 CDI 4-matic (W164)	OM 642.940	07.09 - 12.11	6	165	---	CSS407
ML 400 4-matic (W166)	M 276.821	08.13 ->	6	245	CSS406	---
ML 400 CDI (W163)	OM 628.963	09.01 - 06.05	8	184	---	CSS407
ML 420 CDI 4-matic (W164)	OM 629.912	02.06 - 09.09	8	225	CSS405	CSS403
ML 430 (W163)	M 113.942	02.98 - 06.05	8	200	CSS400	CSS402
ML 450 CDI 4-matic (W164)	OM 629.912	09.09 - 12.11	8	225	CSS405	CSS403
ML 500 (W163)	M 113.964	09.01 - 06.05	8	215	CSS400	CSS402
ML 500 4-matic (W164)	M 273.963	12.07 - 12.11	8	285	CSS405	---
ML 500 4-matic (W166)	M 278.928	02.12 ->	8	300	CSS406	---
ML 500 CDI 4-matic (W164)	M 113.964	07.05 ->	8	225	CSS400	CSS402
ML 55 AMG (W163)	M 113.981	02.00 - 06.05	8	255	CSS400	CSS402
ML 63 AMG 4-matic (W164)	M 156.980	01.06 - 12.11	8	375	CSS405	---
ML 63 AMG 4-matic (W166)	M 157.982	11.11 ->	8	410	CSS406	---
ML 63 AMG 4-matic (W166)	M 157.982	11.11 ->	8	386	CSS406	---
R 280 (W251, V251)	M 272.945	01.07 ->	6	170	CSS405	CSS403
R 280 CDI (W251, V251)	OM 642.872, OM 642.870	05.06 ->	6	140	CSS406	CSS407
R 280 CDI (W251, V251)	OM 642.872, OM 642.950	05.06 ->	6	140	CSS405	---
R 280 CDI 4-matic (W251, V251)	OM 642.950	05.06 ->	6	140	---	CSS407
R 300 (W251, V251)	M 272.945	07.09 ->	6	170	CSS405	CSS403
R 300 CDI (W251, V251)	OM 642.872, OM 642.870	07.09 ->	6	140	CSS406	CSS407
R 300 CDI (W251, V251)	OM 642.872, OM 642.950	07.09 ->	6	140	CSS405	---
R 300 CDI 4-matic (W251, V251)	OM 642.950	07.09 ->	6	140	---	CSS407
R 320 CDI 4-matic (W251, V251)	OM 642.870	01.06 ->	6	155	CSS406	CSS407
R 320 CDI 4-matic (W251, V251)	OM 642.950	01.06 ->	6	165	---	CSS407
R 320 CDI 4-matic (W251, V251)	OM 642.950, OM 642.870	01.06 ->	6	155	CSS405	---
R 350 4-matic (W251, V251)	M 272.967	01.06 ->	6	200	CSS405	CSS403
R 350 CDI 4-matic (W251, V251)	OM 642.870	01.06 ->	6	155	CSS406	CSS407
R 350 CDI 4-matic (W251, V251)	OM 642.872	08.10 ->	6	195	CSS406	CSS407
R 350 CDI 4-matic (W251, V251)	OM 642.872	08.10 ->	6	195	CSS405	---
R 350 CDI 4-matic (W251, V251)	OM 642.950	07.09 ->	6	165	---	CSS407
R 350 CDI 4-matic (W251, V251)	OM 642.950, OM 642.870	01.06 ->	6	155	CSS405	---
R 350 CGI 4-matic (W251, V251)	M 276.958	01.06 ->	6	225	CSS406	---
R 500 (W251, V251)	M 273.963	02.06 ->	8	285	---	CSS403
R 500 4-matic (W251, V251)	M 273.963	01.07 ->	8	285	CSS405	---
R 63 AMG (W251, V251)	M 156.983	02.06 ->	8	375	---	CSS403
R 63 AMG 4-matic (W251, V251)	M 156.980	02.06 ->	8	375	CSS405	---
S 280 (W140)	M 104.944	02.93 - 10.98	6	142	---	CSS404
S 280 (W220)	M 112.922	10.98 - 08.05	6	150	CSS400	CSS402
S 280 (W221)	M 272.946	08.06 - 12.13	6	170	CSS405	---
S 300 (W221)	M 272.946	08.06 - 12.13	6	170	CSS405	---
S 300 BlueTEC Hybrid/h (W222, V222, X222)	OM 651.921	02.14 ->	4	150	CSS406	---

Typ Type	Motornummer Engine-No.	Baujahr Year	Zyl. Cyl.	KW	Kurbelwellen- sensor Crankshaft S.	Nocken- wellensensor Camshaft S.
S 300 BlueTEC Hybrid/h (W222, V222, X222)	OM 651.921	02.14 ->	4	170	CSS406	---
S 300 SE 2.8 (W140)	M 104.944	01.93 - 10.98	6	145	---	CSS404
S 300 SE,SEL/S320 (W140)	M 104.990, M 104.994	03.91 - 10.98	6	170	---	CSS404
S 300 Turbo-D (W140)	OM 606.961	05.96 - 10.98	6	130	CSS401	---
S 320 (W220)	M 112.944	10.98 - 08.05	6	165	CSS400	CSS402
S 320 (W222, V222, X222)	M 276.824	05.14 ->	6	200	CSS406	---
S 320 CDI (W211)	OM 642.930	10.05 - 12.13	6	155	---	CSS407
S 320 CDI (W220)	OM 613.960	08.99 - 09.02	6	145	---	CSS407
S 320 CDI (W220)	OM 648.960	09.02 - 08.05	6	150	---	CSS407
S 320 Cdi (W221)	OM 642.930	12.05 - 06.09	6	173	---	CSS407
S 320 CDI 4-matic (W221)	OM 642.932	10.06 - 12.13	6	173	---	CSS407
S 350 (W220)	M 112.972	09.02 - 08.05	6	180	CSS400	CSS402
S 350 (W221)	M 272.965	10.05 - 12.13	6	200	CSS405	CSS402
S 350 4-matic (W221)	M 272.975	02.08 - 12.13	6	200	CSS405	---
S 350 BlueTEC (W221)	OM 642.862	04.11 - 12.13	6	190	CSS406	CSS407
S 350 BlueTec (W221)	OM 642.862	04.11 - 12.13	6	190	CSS405	---
S 350 BlueTEC 4-matic (W221)	OM 642.868	04.11 - 12.13	6	190	CSS406	CSS407
S 350 BlueTEC 4-matic (W221)	OM 642.868	04.11 - 12.13	6	190	CSS405	---
S 350 BlueTEC 4-matic (W222, V222, X222)	OM 642.867	02.14 ->	6	185	CSS406	CSS407
S 350 BlueTEC/d (W222, V222, X222)	OM 642.861	05.13 ->	6	190	CSS406	CSS407
S 350 BlueTEC/d 4-matic (W222,V222, X222)	OM 642.861, OM 642.867	02.14 ->	6	190	---	CSS407
S 350 CDI (W221)	OM 642.930	06.09 - 12.13	6	173	---	CSS407
S 350 CDI 4-matic (W221)	OM 642.932	01.09 - 12.10	6	155	---	CSS407
S 350 CGI (W221)	M 276.950	04.11 - 12.13	6	225	CSS406	---
S 350 CGI 4-matic (W221)	M 276.950	04.11 - 12.13	6	225	CSS406	---
S 400 (W222, V222, X222)	M 276.824	03.14 ->	6	245	CSS406	---
S 400 4-matic (W222, V222, X222)	M 276.824	11.14 ->	6	245	CSS406	---
S 400 4-matic Coupe (C217)	M 276.824	10.15 ->	6	270	CSS406	---
S 400 CDI (W220)	OM 628.960	06.00 - 08.05	8	184	---	CSS407
S 400 CDI (W220)	OM 628.960	06.03 - 08.05	8	191	---	CSS407
S 400 Hybrid (W221)	M 272.974	01.09 - 12.13	6	205	CSS405	CSS403
S 400 Hybrid/h (W222, V222, X222)	M 276.960	05.13 ->	6	225	CSS406	---
S 420 CDI (W221)	OM 629.911	10.06 - 12.13	8	235	---	CSS403
S 430 (W220)	M 113.941	10.98 - 08.05	8	205	CSS400	CSS402
S 450 (W221)	M 271.923	12.05 - 12.13	8	250	---	CSS403
S 450 (W221)	M 273.922	12.05 - 12.13	8	250	CSS405	---
S 450 4-matic (W221)	M 273.924	12.05 - 12.13	8	250	CSS405	---
S 500 (W220)	M 113.960	10.98 - 08.05	8	225	CSS400	CSS402
S 500 (W221)	M 273.961	10.05 - 12.13	8	285	CSS405	CSS403
S 500 (W222, V222, X222)	M 278.929	05.13 ->	8	335	CSS406	---
S 500 4-matic (C217)	M 278.929	04.14 ->	8	335	CSS406	---
S 500 4-matic (W221)	M 273.961, M 273.968	10.05 - 12.13	8	285	CSS405	---
S 500 4-matic (W222, V222, X222)	M 278.929	05.13 ->	8	335	CSS406	---
S 500 Cabriolet (A217)	M 278.929	12.15 ->	8	335	CSS406	---
S 500 CGI 4-matic (W221)	M 278.932	03.11 - 12.13	8	320	CSS406	---
S 500 Coupe (C217)	M 278.929	11.14 ->	8	335	CSS406	---
S 500 Hybrid/e (W222, V222, X222)	M 276.824	07.14 ->	6	245	CSS406	---
S 500 Maybach (W222, V222, X222)	M 278.929	12.14 ->	8	335	CSS406	---
S 500 Maybach 4-matic (W222, V222, X222)	M 278.929	04.15 ->	8	335	CSS406	---
S 55 AMG (W220)	M 113.986	04.99 - 08.05	8	265	CSS400	CSS402
S 55 AMG Kompressor (W220)	M 113.991	06.02 - 08.05	8	368	CSS400	CSS402
S 600 (W222, V222, X222)	M 277.980	02.14 ->	12	390	CSS406	CSS403
S 600 Maybach (W222, V222, X222)	M 277.980	12.14 ->	12	390	CSS406	CSS403
S 63 AMG (W221)	M 156.983	10.06 - 12.13	8	386	---	CSS403
S 63 AMG (W221)	M 156.984	10.06 - 12.13	8	386	CSS405	---
S 63 AMG (W221)	M 157.980	02.12 - 12.13	8	420	CSS406	---
S 63 AMG (W221)	M 157.980	03.11 - 12.13	8	400	CSS406	---
S 63 AMG (W222, V222, X222)	M 157.985	05.13 ->	8	430	CSS406	---
S 63 AMG 4-matic (A217)	M 157.985	12.15 ->	8	430	CSS406	---

Typ Type	Motornummer Engine-No.	Baujahr Year	Zyl. Cyl.	KW	Kurbelwellen- sensor Crankshaft S.	Nocken- wellensensor Camshaft S.
S 63 AMG 4-matic (C217)	M 157.985	04.14 ->	8	430	CSS406	---
S 63 AMG 4-matic (W222, V222, X222)	M 157.985	05.13 ->	8	430	CSS406	---
S 63 AMG Coupe (C217)	M 157.985	07.14 ->	8	430	CSS406	---
S 65 AMG (W222, V222, X222)	M 279.980	02.14 ->	12	463	CSS406	CSS403
S 65 AMG Cabriolet (A217)	M 279.980	04.16 ->	12	463	CSS406	---
S 65 AMG Coupe (C217)	M 279.980	07.14 ->	12	463	CSS406	---
S 65 AMG Coupe (C217)	M 279.980	07.14 ->	12	463	---	CSS403
SEC/CL 420 (C140)	M 119.971	10.94 - 02.99	8	205	---	CSS402
SEC/CL 500 (C140)	M 119.970	10.92 - 02.99	8	235	CSS401	CSS402
SL 280 (R129)	M 104.943	08.93 - 10.01	6	142	---	CSS404
SL 280 (R129)	M 112.923	05.98 - 10.01	6	150	CSS400	CSS402
SL 280 (R230)	M 272.949	03.08 - 01.12	8	170	CSS405	CSS403
SL 300 (R230)	M 272.949	04.09 - 01.12	6	170	CSS405	CSS403
SL 320 (R129)	M 104.991	09.93 - 10.01	6	170	---	CSS404
SL 320 (R129)	M 112.943	05.98 - 10.01	6	165	CSS400	CSS402
SL 350 (R230)	M 112.973	03.03 - 01.12	6	180	CSS400	CSS402
SL 350 (R230)	M 272.966	03.06 - 01.12	6	200	CSS405	CSS402
SL 350 (R230)	M 272.968	04.08 - 01.12	6	232	---	CSS403
SL 350 (R231)	M 276.954	02.12 ->	6	225	CSS406	---
SL 400 (R231)	M 276.825	04.14 ->	6	245	CSS406	---
SL 400 (R231)	M 276.825	01.16 ->	6	270	CSS406	---
SL 500 (R129)	M 113.961	05.98 - 10.01	6	225	CSS400	CSS402
SL 500 (R129)	M 119.972, M 119.982	09.92 - 10.01	8	235	CSS401	CSS402
SL 500 (R230)	M 113.963	10.01 - 01.12	8	225	CSS400	CSS402
SL 500 (R230)	M 273.965	03.06 - 01.12	8	285	CSS405	CSS403
SL 500 (R231)	M 278.927	01.12 ->	8	320	CSS406	---
SL 500 (R231)	M 278.927	04.15 ->	8	335	CSS406	---
SL 55 AMG (R230)	M 113.992	10.01 - 06.02	8	350	CSS400	CSS402
SL 55 AMG (R230)	M 113.995	03.06 - 01.12	8	380	CSS400	CSS402
SL 60 AMG (R129)	M 120.981	05.97 - 10.01	8	280	CSS401	CSS402
SL 60 AMG (R129)	M 122.961	05.97 - 10.01	8	280	CSS401	---
SL 600 (R129)	M 120.981, M 120.983	07.92 - 10.01	12	290	CSS401	CSS402
SL 63 AMG (R230)	M 156.981	03.08 - 01.12	8	386	CSS405	CSS403
SL 63 AMG (R231)	M 157.983	01.12 ->	8	395	CSS406	---
SL 63 AMG (R231)	M 157.983	01.12 ->	8	415	CSS406	---
SL 63 AMG (R231)	M 157.983	04.14 ->	8	430	CSS406	---
SL 65 AMG (R231)	M 279.981	05.12 ->	12	463	CSS406	CSS403
SLC 250 d (R172)	OM 651.980	01.16 ->	4	150	CSS406	---
SLC 43 AMG (R172)	M 276.822	01.16 ->	6	270	CSS406	---
SLK 200 (R170)	M 111.946	09.96 - 03.00	4	100	---	CSS404
SLK 200 (R170)	M 111.946	09.96 - 03.00	4	100	CSS401	---
SLK 200 (R172)	M 271.860, M 271.861	02.11 ->	4	135	CSS405	---
SLK 200 (R172)	M 271.861	02.11 ->	4	135	---	CSS403
SLK 200 Kompressor (R170)	M 111.943	10.96 - 03.00	4	141	CSS401	---
SLK 200 Kompressor (R171)	M 271.944	03.04 - 02.11	4	120	CSS400	CSS402
SLK 200 Kompressor (R171)	M 271.954	01.08 - 02.11	4	135	---	CSS403
SLK 200 Koproressor (R170)	M 111.943	10.96 - 03.00	4	141	---	CSS404
SLK 230 Kompressor (R170)	M 111.973	09.96 - 03.00	4	142	CSS401	CSS404
SLK 250 (R172)	M 271.860, M 271.861	02.11 ->	4	150	CSS405	---
SLK 250 CDI/d (R172)	OM 651.980	01.12 ->	4	150	CSS406	---
SLK 280 (R171)	M 272.942	01.05 - 02.11	6	170	---	CSS403
SLK 300 (R171)	M 272.942	04.09 - 02.11	6	170	---	CSS403
SLK 32 AMG Kompressor (R170)	M 112.960	03.01 - 04.04	6	260	CSS400	CSS402
SLK 320 (R170)	M 112.947	03.00 - 04.04	6	160	CSS400	CSS402
SLK 350 (R171)	M 272.963	06.04 - 02.11	6	200	CSS405	---
SLK 350 (R171)	M 272.969	01.08 - 02.11	6	224	---	CSS403
SLK 350 (R172)	M 276.956	02.11 ->	6	225	CSS406	---
SLK 55 AMG (R171)	M 113.989	06.04 - 02.11	8	265	---	CSS403
SLR 5.4 (R199)	M 155.980	04.07 ->	8	460	CSS400	CSS403

Typ Type	Motornummer Engine-No.	Baujahr Year	Zyl. Cyl.	KW	Kurbelwellen- sensor Crankshaft S.	Nocken- wellensensor Camshaft S.
SLR 5.4 722 Edition (R199)	M 155.980	10.06 ->	8	478	CSS400	CSS403
Sprinter 208 CDI 2-t (901, 902)	OM 611.987	04.00 - 05.06	4	60	---	CSS407
Sprinter 210 D 2-t (901, 902)	OM 602.980	03.97 - 04.00	5	75	CSS401	---
Sprinter 211 CDI 2-t (901, 902)	OM 611.981	04.00 - 05.06	4	80	---	CSS407
Sprinter 211 CDI 3-t (906)	OM 646.985	06.06 - 12.09	4	80	---	CSS407
Sprinter 211 CDI 3-t (906)	OM 651.955	04.16 ->	4	84	CSS406	---
Sprinter 212 D 2-t (901, 902)	OM 602.980	02.95 - 04.00	5	90	CSS401	---
Sprinter 213 CDI 2-t (901, 902)	OM 611.981	04.00 - 05.06	4	95	---	CSS407
Sprinter 213 CDI 3-t (906)	OM 651.956, OM 651.955	06.06 - 05.16	4	95	CSS406	---
Sprinter 214 2-t (901, 902)	M 111.979, M 111.984	02.95 - 05.06	4	105	---	CSS404
Sprinter 214 CDI 3-t (906)	OM 651.955	04.16 ->	4	105	CSS406	---
Sprinter 215 CDI 3-t (906)	OM 646.986, OM 646.989	06.06 - 12.09	4	110	---	CSS407
Sprinter 216 3-t (906)	M 271.951	09.08 ->	4	115	---	CSS403
Sprinter 216 CDI 2-t (901, 902)	OM 612.981	04.00 - 05.06	5	115	---	CSS407
Sprinter 216 CDI 3-t (906)	OM 651.955	06.06 ->	4	120	CSS406	---
Sprinter 224 3-t (906)	M 272.979	06.06 ->	6	190	CSS405	CSS402
Sprinter 308 CDI 3-t (903)	OM 611.987	04.00 - 05.06	4	60	---	CSS407
Sprinter 310 CDI 3,5-t (906)	OM 651.956, OM 651.955	03.09 - 12.13	4	70	CSS406	---
Sprinter 310 D 3-t (903)	OM 602.980	05.97 - 08.02	5	75	CSS401	---
Sprinter 311 CDI 3,5-t (906)	OM 646.985	06.06 - 12.09	4	80	---	CSS407
Sprinter 311 CDI 3-t (903)	OM 611.981	04.00 - 05.06	4	80	CSS400	CSS407
Sprinter 311 CDI 4x4 3,5-t (906)	OM 646.985	02.08 - 12.09	4	80	---	CSS407
Sprinter 311 CDI 4x4 3-t (903)	OM 611.981	08.02 - 05.06	4	80	---	CSS407
Sprinter 312 D 3-t (903)	OM 602.980	02.95 - 04.00	5	90	CSS401	---
Sprinter 313 CDI 3,5-t (906)	OM 651.956, OM 651.955	08.11 - 05.16	4	95	CSS406	---
Sprinter 313 CDI 3-t (903)	OM 611.981	04.00 - 05.06	4	95	CSS400	CSS407
Sprinter 313 CDI 4x4 3,5-t (906)	OM 651.956, OM 651.955	08.11 - 05.16	4	95	CSS406	---
Sprinter 314 3-t (903)	M 111.984	02.95 - 05.06	4	105	---	CSS404
Sprinter 315 CDI 3,5-t (906)	OM 646.989, OM 646.990	06.06 - 12.09	4	110	---	CSS407
Sprinter 315 CDI 4x4 3,5-t (906)	OM 646.989, OM 646.990	02.08 - 12.09	4	110	---	CSS407
Sprinter 316 3.5-t (906)	M 271.951	09.08 ->	4	115	---	CSS403
Sprinter 316 3.5-t NTG (906)	M 271.951	09.08 ->	4	115	---	CSS403
Sprinter 316 CDI 3-t (903)	OM 612.981	04.00 - 05.06	5	115	---	CSS407
Sprinter 316 CDI 4x4 3-t (903)	OM 612.981	08.02 - 05.06	5	115	---	CSS407
Sprinter 318 CDI 3,5-t (906)	OM 642.992, OM 642.993	02.08 - 12.09	6	135	CSS406	CSS407
Sprinter 318 CDI 4x4 3,5-t (906)	OM 642.992, OM 642.993	02.08 - 12.09	6	135	CSS406	---
Sprinter 319 CDI/BlueTEC 3,5-t (906)	OM 642.898, OM 642.992	03.09 ->	6	140	CSS406	CSS407
Sprinter 319 CDI/BlueTEC 4x4 3,5-t (906)	OM 642.898, OM 642.992	03.09 ->	6	140	CSS406	CSS407
Sprinter 324 3.5-t (906)	M 272.979	06.06 ->	6	190	CSS405	CSS402
Sprinter 410 D 4-t (903)	OM 602.980	02.96 - 05.06	5	75	CSS401	---
Sprinter 412 D 4-t (903)	OM 602.980	02.96 - 05.06	5	90	CSS401	---
Sprinter 414 4-t (904)	M 111.979	02.96 - 05.06	4	105	---	CSS404
Sprinter 424 4.6-t (906)	M 272.979	06.06 ->	6	190	CSS405	CSS402
Sprinter 516 5-t (906)	M 271.951	09.08 ->	4	115	---	CSS403
Sprinter 519 CDI/BlueTEC 4x4 5-t Box (906)	OM 642.896, OM 642.898	03.09 ->	6	140	---	CSS407
Sprinter 524 5-t (906)	M 272.979	06.06 ->	6	190	CSS405	---
V 200 (638/2)	M 111.948, M 111.950	02.97 - 07.03	4	95	---	CSS404
V 200 CDI (638/2)	OM 611.980	03.99 - 07.03	4	75	---	CSS407
V 200 CDI/d (W447)	OM 651.950	03.14 ->	4	100	CSS406	---
V 200 CDI/d 4-matic (W447)	OM 651.950	04.15 ->	4	100	CSS406	---
V 220 CDI (638/2)	OM 611.980	03.99 - 07.03	4	90	---	CSS407
V 220 CDI/d (W447)	OM 651.950	03.14 ->	4	120	CSS406	---
V 220 CDI/d 4-matic (W447)	OM 651.950	04.15 ->	4	120	CSS406	---
V 230 (638/2)	M 111.978	10.96 - 07.03	4	105	---	CSS404
V 250 BlueTEC/d (W447)	OM 651.950	03.14 ->	4	140	CSS406	---
V 250 BlueTEC/d 4-matic (W447)	OM 651.950	12.14 ->	4	140	CSS406	---
Vaneo 1.6 (414)	M 166.961	02.02 - 07.05	4	75	---	CSS407
Vaneo 1.7 CDI (414)	OM 668.914	02.02 - 07.05	4	55	---	CSS407
Vaneo 1.7 CDI (414)	OM 668.914	02.02 - 07.05	4	67	---	CSS407

Typ Type	Motornummer Engine-No.	Baujahr Year	Zyl. Cyl.	KW	Kurbelwellen- sensor Crankshaft S.	Nocken- wellensensor Camshaft S.
Vaneo 1.9 (414)	M 166.991	02.02 - 07.05	4	92	---	CSS407
Viano 3.0 (W639)	M 112.951	09.03 ->	6	140	CSS400	CSS402
Viano 3.2 (W639)	M 112.951	09.03 ->	6	160	CSS400	CSS402
Viano 3.5 (W639)	M 272.978	09.07 ->	6	190	CSS405	---
Viano 3.5 (W639)	M 272.979	09.07 ->	6	190	---	CSS403
Viano 3.7 (W639)	M 112.976	06.04 ->	6	170	CSS400	CSS402
Viano CDI 2.0 (W639)	OM 646.982	09.03 ->	4	80	---	CSS407
Viano CDI 2.0 (W639)	OM 646.982	08.05 ->	4	85	---	CSS407
Viano CDI 2.0 4-matic (W639)	OM 646.982	07.05 ->	4	80	---	CSS407
Viano CDI 2.2 (W639)	OM 646.980, OM 646.982	09.03 ->	4	110	---	CSS407
Viano CDI 2.2 4-matic (W639)	OM 646.982	07.05 ->	4	110	---	CSS407
Viano CDI 3.0 (W639)	OM 642.990	07.10 ->	6	165	---	CSS407
Viano CDI 3.0 (W639)	OM 642.990	03.06 ->	6	150	---	CSS407
Vito / Mixto 126 (W639)	M 272.978	09.07 ->	6	190	CSS405	---
Vito 108 CDI 2.2 (638)	OM 611A (60 KW CDI)	03.99 - 07.03	4	60	---	CSS407
Vito 109 CDI 4x4 (W639)	OM 646.981	09.07 ->	4	70	---	CSS407
Vito 109 CDI (W639)	OM 646.983	09.03 ->	4	65	---	CSS407
Vito 110 CDI 2.2 (638)	OM 611LA (75 KW CDI)	03.99 - 07.03	4	75	---	CSS407
Vito 111 CDI / 111 BlueTEC (W447)	OM 622.951	10.14 ->	4	84	CSS1537	---
Vito 111 CDI 4x4 (W639)	OM 646.982	09.07 ->	4	80	---	CSS407
Vito 111 CDI (W639)	OM 646.980	09.07 ->	4	85	---	CSS407
Vito 111 CDI (W639)	OM 646.982	09.03 ->	4	80	---	CSS407
Vito 112 CDI 2.2 (638)	OM 611.980	03.99 - 07.03	4	90	---	CSS407
Vito 113 (W638)	M 111.948, M 111.950	02.96 - 07.03	4	95	---	CSS404
Vito 114 (W638)	M 111.978	12.96 - 07.03	4	105	---	CSS404
Vito 114 CDI / 114 BlueTEC (W447)	OM 651.950	10.14 ->	4	100	CSS1537	---
Vito 114 CDI/114 BlueTEC 4x4 Tourer (W447)	OM 651.950	07.15 ->	4	100	CSS406	---
Vito 114 CDI/114 BlueTEC Tourer (W447)	OM 651.950	10.14 ->	4	100	CSS406	---
Vito 115 CDI 4x4 (W639)	OM 646.982	09.07 ->	4	110	---	CSS407
Vito 115 CDI (W639)	OM 646.980, OM 646.982	09.03 ->	4	110	---	CSS407
Vito 116 CDI/116 BlueTEC 4x4 Tourer (W447)	OM 651.950	07.15 ->	4	120	CSS406	---
Vito 116 CDI/116 BlueTEC Tourer (W447)	OM 651.950	10.14 ->	4	120	CSS406	---
Vito 119 (W639)	M 112.951	09.03 ->	6	140	CSS400	CSS402
Vito 119 BlueTEC Tourer (W447)	OM 651.950	10.14 ->	4	140	CSS406	---
Vito 119 CDI/BlueTEC 4x4 Tourer (W447)	OM 651.950	12.14 ->	4	140	CSS406	---
Vito 120 CDI (W639)	OM 642.990	07.06 ->	6	150	---	CSS407
Vito 122 (W639)	M 112.951	09.03 ->	6	160	CSS400	CSS402
Vito 122 CDI (W639)	OM 642.890	09.10 ->	6	165	CSS406	CSS407
Vito 123 (W639)	M 112.976	06.04 - 07.08	6	170	CSS400	CSS402
Vito 126 (W639)	M 272.978	09.07 ->	6	190	CSS405	CSS403
Vito/Mixto 109 CDI Box (W639)	OM 646.980, OM 646.981	08.06 ->	4	70	---	CSS407
Vito/Mixto 109 CDI Box (W639)	OM 646.983	09.03 ->	4	65	---	CSS407
Vito/Mixto 111 CDI 4x4 Box (W639)	OM 646.982	09.07 ->	4	80	---	CSS407
Vito/Mixto 111 CDI Box (W639)	OM 646.980, OM 646.982	09.07 ->	4	85	---	CSS407
Vito/Mixto 111 CDI Box (W639)	OM 646.982	09.03 ->	4	80	---	CSS407
Vito/Mixto 115 CDI 4x4 Box (W639)	OM 646.982	07.06 ->	4	110	---	CSS407
Vito/Mixto 115 CDI Box (W639)	OM 646.980, OM 646.982	09.03 ->	4	110	---	CSS407
Vito/Mixto 120 CDI Box (W639)	OM 642.990	07.06 ->	6	150	---	CSS407
<b>Mini</b>						
Clubman Cooper (R55)	N16 B16 A	03.10 - 06.15	4	85	CSS912	CSS920
Clubman Cooper (R55)	N16 B16 A	03.10 - 06.15	4	90	CSS912	CSS920
Clubman Cooper (R55)	N16 B16 A	12.12 ->	4	90	CSS912	---
Clubman Cooper (R55)	N16 B16 A, N12 B16 A	10.07 - 12.13	4	88	CSS912	CSS920
Clubman Cooper S (R55)	N14 B16 A	10.07 - 02.10	4	120	CSS912	CSS920
Clubman Cooper S (R55)	N14 B16 A	10.07 - 02.10	4	128	CSS912	CSS920
Clubman Cooper S (R55)	N18 B16 A	03.10 - 06.15	4	135	CSS912	CSS920
Clubman Cooper S (R55)	N18 B16 A	03.10 - 06.15	4	147	CSS912	CSS920
Clubman John Cooper Works (R55)	N14 B16 A	10.08 ->	4	141	CSS912	---

Typ Type	Motornummer Engine-No.	Baujahr Year	Zyl. Cyl.	KW	Kurbelwellen- sensor Crankshaft S.	Nocken- wellensensor Camshaft S.
Clubman John Cooper Works (R55)	N14 B16 C	03.08 - 08.12	4	155	CSS912	CSS920
Clubman One(R55)	N12 B14 A	03.09 - 02.10	4	70	CSS912	CSS920
Clubman One(R55)	N16 B16 A	03.10 - 06.15	4	72	CSS912	CSS920
Clubman One(R55)	N16 B16 A	12.12 ->	4	72	CSS912	---
Clubmann Cooper 1.6 D (R55)	9HZ (DW6TED4)	10.07 - 02.10	4	80	CSS1517	---
Cooper (F55)	B36 A15 A, B38 A15 A	09.13 ->	3	100	---	CSS922
Cooper (F56)	B36 A15 A, B38 A15 A	04.13 ->	3	100	---	CSS922
Cooper (R50, R53)	W10 B16 A	06.01 - 09.06	4	85	---	CSS921
Cooper (R56)	N12 B16 A	10.06 - 02.12	4	88	CSS912	CSS920
Cooper (R56)	N16 B16 A	09.09 - 11.13	4	90	CSS912	CSS920
Cooper (R56)	N16 B16 A, N12 B16 A	03.10 - 11.13	4	85	CSS912	CSS920
Cooper Cabriolet (R52)	W10 B16 A	07.04 - 11.07	4	85	---	CSS921
Cooper Cabriolet (R57)	N12 B16 A	03.09 ->	4	88	CSS912	CSS920
Cooper Cabriolet (R57)	N16 B16 A	03.09 ->	4	85	CSS912	CSS920
Cooper Cabriolet (R57)	N16 B16 A	03.10 ->	4	90	CSS912	CSS920
Cooper Clubman (F54)	B36 A15 A, B38 A15 A	12.14 ->	3	100	---	CSS922
Cooper Clubvan (R55)	N16 B16 A	12.12 ->	4	90	---	CSS920
Cooper Convertible (F57)	B36 A15 A, B38 A15 A	11.14 ->	3	100	---	CSS922
Cooper Coupe (R58)	N16 B16 A	09.11 ->	4	85	---	CSS920
Cooper Coupe (R58)	N16 B16 A	09.11 ->	4	90	---	CSS920
Cooper D (F55)	B37 C15 A	10.13 ->	3	85	---	CSS922
Cooper D (F56)	B37 C15 A	12.13 ->	3	85	---	CSS922
Cooper D Clubman (F54)	B47 C20 A	12.14 ->	4	110	---	CSS922
Cooper D Clubman (F54)	B47 C20 A	12.14 ->	4	100	---	CSS922
Cooper D Convertible (F57)	B37 C15 A	12.14 ->	3	85	---	CSS922
Cooper S (F55)	B46 A20 A, B48 A20 A	09.13 ->	4	141	---	CSS922
Cooper S (F55)	B48 A20 A	09.13 ->	4	120	---	CSS922
Cooper S (F56)	B46 A20 A, B48 A20 A	04.13 ->	4	141	---	CSS922
Cooper S (R50, R53)	W11 B16 A	03.02 - 09.06	4	120	---	CSS921
Cooper S (R50, R53)	W11 B16 A	07.04 - 09.06	4	125	---	CSS921
Cooper S (R56)	N14 B16 A	10.06 - 01.11	4	128	CSS912	CSS920
Cooper S (R56)	N18 B16 A	03.10 - 11.13	4	120	CSS912	CSS920
Cooper S (R56)	N18 B16 A	03.10 - 11.13	4	135	CSS912	CSS920
Cooper S (R56)	N18 B16 A	01.12 - 11.13	4	147	CSS912	CSS920
Cooper S (R56)	N18 B16 A	03.10 - 11.13	4	135	CSS706	---
Cooper S All4 Clubman (F54)	B48 A20 A	04.15 ->	4	141	---	CSS922
Cooper S All4 Clubman (F54)	B48 A20 A	04.15 ->	4	120	---	CSS922
Cooper S Cabriolet (R52)	W11 B16 A	07.04 - 11.07	4	125	---	CSS921
Cooper S Cabriolet (R52)	W11 B16 A	07.04 - 11.07	4	120	---	CSS921
Cooper S Cabriolet (R57)	N14 B16 A	03.09 ->	4	128	CSS912	CSS920
Cooper S Cabriolet (R57)	N18 B16 A	03.10 ->	4	135	CSS912	CSS920
Cooper S Cabriolet (R57)	N18 B16 A	03.10 - 06.15	4	147	CSS912	CSS920
Cooper S Clubman (F54)	B46 A20 A, B48 A20 A	11.14 ->	4	141	---	CSS922
Cooper S Clubman (F54)	B48 A20 A	11.14 ->	4	120	---	CSS922
Cooper S Convertible (F57)	B46 A20 A, B48 A20 A	11.14 ->	4	141	---	CSS922
Cooper S Convertible (F57)	B48 A20 A	11.14 ->	4	120	---	CSS922
Cooper S Coupe (R58)	N18 B16 A	09.11 ->	4	120	---	CSS920
Cooper S Coupe (R58)	N18 B16 A	09.11 ->	4	135	---	CSS920
Cooper S Coupe (R58)	N18 B16 A	09.11 ->	4	147	---	CSS920
Cooper S Roadster (R59)	N18 B16 A	02.12 ->	4	120	CSS912	CSS920
Cooper S Roadster (R59)	N18 B16 A	02.12 ->	4	135	CSS912	CSS920
Cooper S Roadster (R59)	N18 B16 A	02.12 ->	4	147	CSS912	CSS920
Cooper SD (F55)	B47 C20 A	09.13 ->	4	125	---	CSS922
Cooper SD (F55)	B47 C20 A	09.13 ->	4	120	---	CSS922
Cooper SD (F56)	B47 C20 A	10.13 ->	4	125	---	CSS922
Cooper SD (F56)	B47 C20 A	10.13 ->	4	120	---	CSS922
Cooper SD All4 Clubman (F54)	B47 C20 A	04.15 ->	4	140	---	CSS922
Cooper SD Clubman (F54)	B47 C20 A	02.15 ->	4	140	---	CSS922
Cooper SD Clubman (F54)	B47 C20 A	02.15 ->	4	120	---	CSS922

Typ Type	Motornummer Engine-No.	Baujahr Year	Zyl. Cyl.	KW	Kurbelwellen- sensor Crankshaft S.	Nocken- wellensensor Camshaft S.
Cooper SD Convertible (F57)	B47 C20 A	05.15 ->	4	125	---	CSS922
Cooper SD Convertible (F57)	B47 C20 A	05.15 ->	4	120	---	CSS922
Countryman Cooper (F60)	B36 A15 A, B38 A15 A	10.16 ->	3	100	---	CSS922
Countryman Cooper (R60)	N16 B16 A	06.10 ->	4	85	CSS912	CSS920
Countryman Cooper (R60)	N16 B16 A	09.10 ->	4	88	---	CSS920
Countryman Cooper (R60)	N16 B16 A	06.10 ->	4	90	CSS912	CSS920
Countryman Cooper All4 (F60)	B38 A15 A	10.16 ->	3	100	---	CSS922
Countryman Cooper All4 (R60)	N16 B16 A	11.14 ->	4	90	---	CSS920
Countryman Cooper All4 (R60)	N18 B16 A	11.14 ->	4	90	---	CSS920
Countryman Cooper D (F60)	B47 C20 A	10.16 ->	4	110	---	CSS922
Countryman Cooper D (F60)	B47 C20 A	10.16 ->	4	100	---	CSS922
Countryman Cooper D All4 (F60)	B47 C20 A	10.16 ->	4	110	---	CSS922
Countryman Cooper D All4 (F60)	B47 C20 A	10.16 ->	4	100	---	CSS922
Countryman Cooper S (F60)	B46 A20 A, B48 A20 A	10.16 ->	4	141	---	CSS922
Countryman Cooper S (F60)	B46 A20 A, B48 A20 A	10.16 ->	4	120	---	CSS922
Countryman Cooper S (R60)	N18 B16 A	06.10 - 06.15	4	135	CSS912	CSS920
Countryman Cooper S (R60)	N18 B16 A	07.14 ->	4	140	---	CSS920
Countryman Cooper S (R60)	N18 B16 A	02.12 ->	4	147	CSS912	CSS920
Countryman Cooper S All4 (F60)	B46 A20 A, B48 A20 A	10.16 ->	4	141	---	CSS922
Countryman Cooper S All4 (F60)	B46 A20 A, B48 A20 A	10.16 ->	4	120	---	CSS922
Countryman Cooper S All4 (R60)	N18 B16 A	06.10 ->	4	120	CSS912	CSS920
Countryman Cooper S All4 (R60)	N18 B16 A	06.10 ->	4	135	CSS912	CSS920
Countryman Cooper S All4 (R60)	N18 B16 A	07.14 ->	4	140	---	CSS920
Countryman Cooper S JCW (R60)	N18 B16 A	09.12 ->	4	160	CSS912	---
Countryman Cooper SD (F60)	B47 C20 A	10.16 ->	4	140	---	CSS922
Countryman Cooper SD (F60)	B47 C20 A	10.16 ->	4	120	---	CSS922
Countryman Cooper SD All4 (F60)	B47 C20 A	10.16 ->	4	140	---	CSS922
Countryman Cooper SD All4 (F60)	B47 C20 A	10.16 ->	4	120	---	CSS922
Countryman John Cooper Works All4 (F60)	B48 A20 B	10.10 ->	4	170	---	CSS922
Countryman John Cooper Works All4 (R60)	N18 B16 A	09.12 ->	4	160	---	CSS920
Countryman One (R60)	N16 B16 A	06.10 ->	4	72	CSS912	CSS920
John Cooper Works (F56)	B48 A20 B	06.14 ->	4	170	---	CSS922
John Cooper Works (R50, R53)	W11 B16 A	03.06 - 09.06	4	160	---	CSS921
John Cooper Works (R56)	N14 B16 A	07.07 ->	4	141	CSS912	---
John Cooper Works (R56)	N14 B16 C	03.08 - 11.13	4	155	CSS913	CSS920
John Cooper Works Cabriolet (R52)	W11 B16 A	07.04 - 11.07	4	155	---	CSS921
John Cooper Works Cabriolet (R57)	N14 B16 C	03.08 ->	4	155	CSS912	CSS920
John Cooper Works Clubman (F54)	B48 A20 B	11.15 ->	4	170	---	CSS922
John Cooper Works Convertible (F57)	B48 A20 B	05.15 ->	4	170	---	CSS922
John Cooper Works Coupe (R58)	N14 B16 C	09.11 ->	4	155	---	CSS920
John Cooper Works GP (R56)	N18 B16 B	09.12 ->	4	160	CSS912	---
John Cooper Works GP (R56)	N18 B16 C	09.12 - 11.13	4	160	---	CSS920
John Cooper Works Roadster (R59)	N14 B16 C	02.12 ->	4	155	CSS912	---
John Cooper Works Roadster (R59)	N14 B16 C, N18 B16 C	02.12 ->	4	155	---	CSS920
One (F55)	B38 A12 A	02.14 ->	3	75	---	CSS922
One (F56)	B38 A12 A	06.13 ->	3	75	---	CSS922
One (R50, R53)	W10 B16 A	06.01 - 09.06	4	66	---	CSS921
One (R56)	N12 B14 A	03.09 - 03.10	4	55	CSS912	CSS920
One (R56)	N12 B14 A	11.06 - 03.10	4	70	CSS912	CSS920
One (R56)	N16 B16 A	03.10 - 11.13	4	55	CSS912	CSS920
One (R56)	N16 B16 A	03.10 - 11.13	4	72	CSS912	CSS920
One Cabriolet (R52)	W10 B16 A	07.04 - 11.07	4	66	---	CSS921
One Cabriolet (R57)	N16 B16 A	03.10 ->	4	72	CSS912	CSS920
One Clubman (F54)	B38 A15 A	02.15 ->	3	75	---	CSS922
One Clubvan (R55)	N16 B16 A	12.12 ->	4	72	---	CSS920
One Convertible (F57)	B38 A12 A	06.15 ->	3	75	---	CSS922
One D (F55)	B37 C15 A	02.14 ->	3	70	---	CSS922
One D (F56)	B37 C15 A	07.13 ->	3	70	---	CSS922
One D (R50, R56)	1ND	06.03 - 09.06	4	55	---	CSS914

Typ Type	Motornummer Engine-No.	Baujahr Year	Zyl. Cyl.	KW	Kurbelwellen- sensor Crankshaft S.	Nocken- wellensensor Camshaft S.
One D (R50, R56)	1ND-TV	06.03 - 09.06	4	65	---	CSS914
One D Clubman (F54)	B37 C15 A	02.15 ->	3	85	---	CSS922
Paceman Cooper (R61)	N16 B16 A	04.12 ->	4	90	CSS912	CSS920
Paceman Cooper (R61)	N16 B16 A	02.12 ->	4	85	CSS912	CSS920
Paceman Cooper (R61)	N16 B16 A	02.12 ->	4	90	CSS912	CSS920
Paceman Cooper All4 (R61)	N16 B16 A	07.14 ->	4	90	---	CSS920
Paceman Cooper All4 (R61)	N18 B16 A	11.14 ->	4	90	---	CSS920
Paceman Cooper S (R61)	N18 B16 A	04.12 ->	4	135	CSS912	CSS920
Paceman Cooper S (R61)	N18 B16 A	07.14 ->	4	140	---	CSS920
Paceman Cooper S All4 (R61)	N18 B16 A	04.12 ->	4	135	CSS912	CSS920
Paceman Cooper S All4 (R61)	N18 B16 A	07.14 ->	4	140	---	CSS920
Paceman John Cooper Works (R61)	N18 B16 C	09.12 ->	4	160	CSS912	CSS920
Works (R50, R53)	W11 B16 A	11.03 - 09.06	4	155	---	CSS921
Works S (R50, R53)	W11 B16 A	11.03 - 06.05	4	147	---	CSS921

### Mitsubishi

Carisma 1.6	4 G 92	07.95 - 06.06	4	66	CSS1528	---
Carisma 1.6	4 G 92	05.97 - 06.06	4	73	CSS1528	---
Carisma 1.8	4 G 93	07.95 - 06.06	4	85	CSS1528	---
Carisma 1.8 16V	4 G 93	07.95 - 06.06	4	103	CSS1528	---

### Nissan

350 Z 3.5	VQ 35 DE	10.03 ->	6	206	---	CSS1604
350 Z 3.5	VQ 35 DE	09.02 ->	6	221	---	CSS1604
350 Z Roadster 3.5	VQ 35 DE	03.05 ->	6	206	---	CSS1604
350 Z Roadster 3.5	VQ 35 DE	04.06 ->	6	221	---	CSS1604
Almera II 1.5 dCi	K9K 722	01.03 ->	4	60	CSS1537	CSS1540
Interstar 1.9 dCi 80	F9Q 772	07.02 ->	4	60	CSS1537	---
Kubistar 1.2	D4F 764	08.03 - 10.09	4	44	CSS1532	---
Kubistar 1.2 16V	D4F 712	04.06 - 10.09	4	55	CSS1532	---
Kubistar 1.5 dCi	K9K 704	08.03 - 10.09	4	48	CSS1537	---
Kubistar 1.5 dCi	K9K 704	08.03 ->	4	48	CSS1541	---
Kubistar 1.5 dCi	K9K 710, K9K 714	08.03 ->	4	42	CSS1541	---
Kubistar 1.5 dCi	K9K 710, K9K 714	08.05 ->	4	45	CSS1541	---
Kubistar 1.5 dCi	K9K 722	08.03 - 10.09	4	60	CSS1537	---
Kubistar 1.5 dCi	K9K 722	08.03 ->	4	60	CSS1541	---
Kubistar 1.5 dCi 70	K9K 716, K9K 700	04.06 ->	4	50	CSS1541	---
Kubistar 1.5 dCi 85	K9K 276	04.06 ->	4	62	CSS1541	---
Micra C+C 1.4 16V	CR 14 DE	08.05 ->	4	65	---	CSS1604
Micra II 1.4 i 16V	CG A3 DE	09.00 - 02.03	4	60	---	CSS1604
Micra III 1.2 16V	CR 12 DE, CG 12 DE	01.03 - 06.10	4	48	---	CSS1604
Micra III 1.2 16V	CR 12 DE, CG 12 DE	01.03 - 06.10	4	59	---	CSS1604
Micra III 1.4 16V	CR 14 DE	01.03 - 06.10	4	65	---	CSS1604
Micra III 1.5 dCi	K9K 276	06.05 - 06.10	4	63	CSS1541	CSS1540
Micra III 1.5 dCi	K9K 704	01.03 - 06.10	4	48	CSS1537	CSS1540
Micra III 1.5 dCi	K9K 708	06.05 - 06.10	4	50	CSS1541	CSS1540
Micra III 1.5 dCi	K9K 722	09.03 - 06.10	4	60	CSS1537	CSS1540
Murano 3.5 4x4	VQ 35 DE	08.03 ->	6	172	---	CSS1604
Note 1.4	CR 14 DE	03.06 ->	4	65	---	CSS1604
Note 1.5 dCi	K9K 276	09.10 ->	4	66	CSS1537	---
Note 1.5 dCi	K9K 276	03.06 ->	4	63	CSS1537	---
Note 1.5 dCi	K9K 276	03.06 ->	4	63	CSS1541	---
Note 1.5 dCi	K9K 276	09.10 ->	4	66	CSS1541	---
Note 1.5 dCi	K9K 292	07.08 ->	4	76	CSS1541	---
Note 1.5 dCi	K9K 700	03.06 ->	4	50	CSS1537	---
Note 1.5 dCi	K9K 700	03.06 ->	4	50	CSS1541	---
Note 1.5 dCi	K9K 892	06.13 ->	4	66	CSS1537	---
Pathfinder 4.0 4WD	VQ 40 DE	09.05 ->	6	198	---	CSS1604
Primastar 1.9 dCi 100	F9Q 760	03.01 ->	4	74	CSS1537	---

Typ Type	Motornummer Engine-No.	Baujahr Year	Zyl. Cyl.	KW	Kurbelwellen- sensor Crankshaft S.	Nocken- wellensensor Camshaft S.
Primastar 1.9 dCi 80	F9Q 762	03.01 ->	4	60	CSS1537	---
Qashqai 1.5 dCi	---	07.08 ->	4	76	---	CSS1540
Qashqai 1.5 dCi	K9K 764, K9K 732	02.07 ->	4	78	CSS1541	CSS1540
Qashqai 1.6 dCi	R9M	10.11 ->	4	96	CSS1537	---
Qashqai II 1.5 dCi	K9K 636	11.13 ->	4	81	CSS1537	---
Qashqai II 1.6 dCi	R9M	11.13 ->	4	96	CSS1537	---
Qashqai II 1.6 dCi ALL MODE 4x4-i	R9M	11.13 ->	4	96	CSS1537	---
Tiida 1.5 dCi	K9K 728	09.07 ->	4	78	CSS1541	---
X-Trail 1.6 dCi	R9M	12.13 ->	4	96	CSS1537	---
X-Trail 1.6 dCi ALL MODE 4x4-i	R9M	12.13 ->	4	96	CSS1537	---
<b>Opel</b>						
Adam 1.2	A 12 XEL, B 12 XEL	10.12 ->	4	51	CSS706	CSS722
Adam 1.4	A 14 XEL, B 14 XEL	10.12 ->	4	64	CSS706	CSS722
Adam 1.4	A 14 XER, B 14 XER	10.12 ->	4	74	CSS706	CSS722
Adam 1.4 LPG	A 14 XEL, B 14 XEL	07.13 ->	4	64	CSS706	CSS722
Agila 1.0	Z 10 XEP	08.03 - 12.07	3	44	---	CSS720
Agila 1.0	Z 10 XEP	08.03 - 12.07	3	44	CSS713	---
Agila 1.0 12V	Z 10 XE	02.00 - 12.07	3	43	CSS713	CSS718
Agila 1.2 16V	Z 12 XE	02.00 - 12.07	4	55	CSS713	CSS718
Agila 1.2 16V Twinport	Z 12 XEP	07.04 - 12.07	4	59	CSS713	CSS720
Agila 1.3 CDTI	Z 13 DT	08.03 - 12.07	4	51	---	CSS716
Agila 1.3 CDTI	Z 13 DT	04.08 ->	4	55	---	CSS716
Agila 1.3 CDTI	Z 13 DT	08.03 - 12.07	4	51	CSS1303	---
Arena 1.9 D	F8Q 600, F8Q 606	03.98 - 08.01	4	44	CSS1534	---
Ascona C 1.8	E 18 NV	09.87 - 08.88	4	62	CSS707	---
Ascona C 2.0 i	20 NE	09.86 - 08.88	4	85	CSS707	---
Ascona C 2.0 i GT	20 SEH	03.87 - 08.88	4	95	CSS707	---
Ascona C 2.0 i KAT	C 20 NE	09.86 - 08.88	4	85	CSS707	---
Ascona C CC 1.8	E 18 NV	09.87 - 08.88	4	62	CSS707	---
Ascona C CC 2.0 i	20 NE	09.86 - 08.88	4	85	CSS707	---
Ascona C CC 2.0 i GT	20 SEH	03.87 - 08.88	4	95	CSS707	---
Ascona C CC 2.0 i KAT	C 20 NE	09.86 - 08.88	4	85	CSS707	---
Astra F 1.4 i 16V	X 14 XE	02.96 - 09.98	4	66	CSS704	---
Astra F 1.4 Si	C 14 SE	03.92 - 09.98	4	60	CSS703	---
Astra F 1.4i 16V	X 14 XE	02.96 - 09.98	4	66	---	CSS700
Astra F 1.6 i	X 16 SZ	05.93 - 07.96	4	52	CSS703	---
Astra F 1.6 i	X 16 SZR	08.96 - 09.98	4	55	CSS703	---
Astra F 1.6 i 16V	X 16 XEL	08.94 - 09.98	4	74	CSS704	---
Astra F 1.6 Si	C 16 SE	05.92 - 12.94	4	74	CSS703	---
Astra F 1.6i 16V	X 16 XEL	08.94 - 09.98	4	74	---	CSS700
Astra F 1.8 i	C 18 NZ	03.92 - 09.98	4	66	CSS714	---
Astra F 1.8 i 16V	C 18 XEL, X 18 XE	11.94 - 09.98	4	85	CSS702	CSS712
Astra F 1.8 i 16V	C 18 XEL, X 18 XE	11.94 - 09.98	4	85	CSS711	CSS701
Astra F 1.8 i 16V	C 18 XEL, X 18 XE	11.94 - 09.98	4	85	CSS711	CSS701
Astra F 2.0 i	C 20 NE	03.92 - 09.98	4	85	CSS714	---
Astra F 2.0 i 16V	X 20 XEV	02.95 - 09.98	4	100	CSS702	---
Astra F 2.0 i 16V	X 20 XEV	02.95 - 09.98	4	100	CSS711	---
Astra F 2.0 i 16V	X 20 XEV	02.95 - 09.98	4	100	---	CSS712
Astra F 2.0 i 16V	X 20 XEV	02.95 - 09.98	4	100	---	CSS701
Astra F Van 1.6 i	X 16 SZ	02.93 - 07.96	4	52	CSS703	---
Astra G 1.2 16V	X 12 XE	09.98 - 09.00	4	48	CSS713	CSS718
Astra G 1.2 16V	Z 12 XE	09.00 - 01.05	4	55	CSS713	CSS718
Astra G 1.4 16V	X 14 XE, Z 14 XE	09.98 - 01.05	4	66	CSS705	CSS700
Astra G 1.6	X 16 SZR	01.99 - 09.00	4	55	CSS705	---
Astra G 1.6	X 16 SZR	09.98 - 09.00	4	55	CSS705	---
Astra G 1.6	Z 16 XEP	12.02 - 01.05	4	76	---	CSS717
Astra G 1.6 16V	X 16 XEL, Z 16 XE	09.98 - 01.05	4	74	CSS705	---
Astra G 1.7 CDTI	Z 17 DTL	04.03 - 01.05	4	59	---	CSS914

Typ Type	Motornummer Engine-No.	Baujahr Year	Zyl. Cyl.	KW	Kurbelwellen- sensor Crankshaft S.	Nocken- wellensensor Camshaft S.
Astra G 1.7 TD	X 17 DTL	01.99 - 04.05	4	50	CSS708	---
Astra G 1.7 TD	X 17 DTL	09.98 - 08.00	4	50	CSS708	---
Astra G 1.8 16V	X 18 XE1	03.00 - 10.00	4	85	CSS710	---
Astra G 1.8 16V	X 18 XE1	09.98 - 09.00	4	85	CSS710	---
Astra G 2.0 DI	X 20 DTL	01.99 - 04.05	4	60	CSS709	---
Astra G 2.0 DI	X 20 DTL, Y 20 DTL	09.98 - 01.05	4	60	CSS709	---
Astra G 2.0 DTI 16V	X 20 DTH, Y 20 DTH	08.99 - 01.05	4	74	CSS709	---
Astra G 2.2 DTI	Y 22 DTR	09.02 - 05.05	4	92	CSS709	---
Astra G 2.2 DTI	Y 22 DTR	09.02 - 01.05	4	92	CSS709	---
Astra G CC 1.4	Z 14 XEP	09.07 - 12.09	4	66	---	CSS720
Astra H 1.2	Z 12 XEP	08.05 - 10.10	4	59	CSS713	CSS720
Astra H 1.3 CDTI	Z 13 DTH	08.05 ->	4	66	---	CSS716
Astra H 1.3 CDTI	Z 13 DTH	04.05 ->	4	66	---	CSS716
Astra H 1.3 CDTI	Z 13 DTH	08.05 ->	4	66	CSS1303	---
Astra H 1.4	Z 14 XEL	04.04 - 10.04	4	55	---	CSS720
Astra H 1.4	Z 14 XEL	04.04 - 10.04	4	59	---	CSS720
Astra H 1.4	Z 14 XEL	04.04 - 10.04	4	55	---	CSS718
Astra H 1.4	Z 14 XEP	03.04 ->	4	66	CSS713	CSS718
Astra H 1.4 LPG	Z 14 XEP	08.09 ->	4	66	CSS713	CSS718
Astra H 1.6	Z 16 XEP	03.04 ->	4	77	---	CSS717
Astra H 1.6 Turbo	Z 16 LET	02.07 - 10.10	4	132	---	CSS720
Astra H 1.7 CDTI	Z 17 DTH	03.04 ->	4	74	---	CSS914
Astra H 1.7 CDTI	Z 17 DTL	03.04 ->	4	59	---	CSS914
Astra H 1.8	A 18 XER, Z 18 XER	01.06 - 10.10	4	103	---	CSS721
Astra H 1.9 CDTI	Z 19 DT	09.05 ->	4	74	CSS1317	---
Astra H 1.9 CDTI	Z 19 DT	09.04 ->	4	110	---	CSS1301
Astra H 1.9 CDTI	Z 19 DTH	09.04 ->	4	110	CSS1300	CSS1301
Astra H 1.9 CDTI	Z 19 DTH	09.05 ->	4	74	---	CSS1301
Astra H 1.9 CDTI 16V	Z 19 DTJ	04.04 ->	4	88	CSS1300	CSS1301
Astra H 1.9 CDTI 16V	Z 19 DTJ	04.04 ->	4	88	---	CSS1301
Astra H Caravan 1.4	Z 14 XEL	08.04 - 10.10	4	55	---	CSS720
Astra H Caravan 1.4	Z 14 XEP	08.04 - 10.10	4	66	---	CSS720
Astra H Caravan 1.4 LPG	Z 14 XEP	08.09 - 10.10	4	66	---	CSS720
Astra H Caravan 1.6	A 16 XER, Z 16 XER	12.06 ->	4	85	CSS719	---
Astra H Caravan 1.6 Turbo	Z 16 LET	02.07 - 10.10	4	132	---	CSS720
Astra H Estate 1.6	A 16 XER, Z 16 XER	12.06 - 05.14	4	85	---	CSS721
Astra H Estate 1.8	A 18 XER, Z 18 XER	08.05 - 10.10	4	103	---	CSS721
Astra H GTC 1.4	Z 14 XEL	03.05 - 10.10	4	55	---	CSS720
Astra H GTC 1.4	Z 14 XEP	03.05 - 10.10	4	66	---	CSS720
Astra H GTC 1.4	Z 14 XEP	03.05 ->	4	66	---	CSS718
Astra H GTC 1.6	Z 16 XEP	03.05 ->	4	77	---	CSS717
Astra H GTC 1.6 Turbo	Z 16 LET	02.07 - 10.10	4	132	---	CSS720
Astra H GTC 1.7 CDTi	Z 17 DTH	03.05 ->	4	74	---	CSS914
Astra H GTC 1.7 CDTI	Z 17 DTL	03.05 ->	4	59	---	CSS914
Astra H GTC 1.8	Z 18 XER	01.06 - 10.10	4	103	---	CSS721
Astra H GTC 1.9 CDTI	Z 19 DT	01.06 ->	4	74	CSS1317	---
Astra H GTC 1.9 CDTI	Z 19 DT	01.06 ->	4	85	CSS1317	---
Astra H Saloon 1.8	A 18 XER, Z 18 XER	02.07 - 10.10	4	103	---	CSS721
Astra H TwinTop 1.6 Turbo	Z 16 LET	02.07 - 10.10	4	132	---	CSS720
Astra H TwinTop 1.8	A 18 XER, Z 18 XER	09.05 - 10.10	4	103	---	CSS721
Astra H TwinTop 1.9 CDTI	Z 19 DTH	09.05 ->	4	110	---	CSS1301
Astra H TwinTop 1.9 CDTI	Z 19 DTH	09.05 ->	4	85	---	CSS1301
Astra J 1.3 CDTI	A 13 DTE	12.09 ->	4	70	---	CSS716
Astra J 1.4	A 14 XEL	12.09 ->	4	64	CSS706	CSS722
Astra J 1.4	A 14 XER	12.09 ->	4	74	CSS706	CSS722
Astra J 1.4 LPG	A 14 NET	01.12 ->	4	103	CSS700	CSS722
Astra J 1.4 Turbo	A 14 NEL, B 14 NEL	10.10 ->	4	88	CSS700	CSS722
Astra J 1.4 Turbo	A 14 NET	12.09 ->	4	103	CSS700	CSS722
Astra J 1.6	A 16 XER, B 16 XER	12.09 ->	4	85	---	CSS715

Typ Type	Motornummer Engine-No.	Baujahr Year	Zyl. Cyl.	KW	Kurbelwellen- sensor Crankshaft S.	Nocken- wellensensor Camshaft S.
Astra J 1.6	A 16 XER, B 16 XER	12.09 ->	4	85	CSS719	CSS721
Astra J 1.6 Turbo	A 16 LET	12.09 ->	4	132	---	CSS715
Astra J 1.7 CDTI	A 17 DTC, A 17 DTE, A 17 DTJ	12.09 ->	4	81	---	CSS722
Astra J 1.7 CDTI	A 17 DTF, A 17 DTS	12.09 ->	4	96	---	CSS722
Astra J 2.0 CDTI	A 20 DTH	12.09 ->	4	118	CSS1300	CSS1301
Astra J GTC 1.4	A 14 NEL, B 14 NEL	10.11 ->	4	88	CSS700	CSS722
Astra J GTC 1.4	A 14 NET, B 14 NET	10.11 ->	4	103	CSS700	CSS722
Astra J GTC 1.4	A 14 XER	10.11 ->	4	74	CSS706	CSS722
Astra J GTC 1.6	A 16 LET	10.11 ->	4	132	---	CSS715
Astra J GTC 1.7 CDTI	A 17 DTC, A 17 DTE, A 17 DTJ	10.11 ->	4	81	---	CSS722
Astra J GTC 1.7 CDTI	A 17 DTF, A 17 DTS	10.11 ->	4	96	---	CSS722
Astra J GTC 1.8	A 18 XER	10.11 ->	4	103	---	CSS721
Astra J Saloon 1.4	A 14 XER	06.12 ->	4	74	CSS706	CSS722
Astra J Saloon 1.4 LPG	A 14 NET	07.14 ->	4	103	CSS700	CSS722
Astra J Saloon 1.4 Turbo	A 14 NEL, B 14 NEL	06.12 ->	4	88	CSS700	CSS722
Astra J Saloon 1.4 Turbo	A 14 NET, B 14 NET (01.15-.)	06.12 ->	4	103	CSS706	CSS722
Astra J Saloon 1.6	A 16 XER, B 16 XER	06.12 ->	4	85	---	CSS721
Astra J Saloon 1.6 Turbo	A 16 LET	06.12 ->	4	132	---	CSS715
Astra J Saloon 1.7 CDTI	A 17 DTC, A 17 DTE, A 17 DTJ	06.12 ->	4	81	---	CSS722
Astra J Saloon 1.7 CDTI	A 17 DTF, A 17 DTS	06.12 ->	4	96	---	CSS722
Astra J Sports Tourer 1.3 CDTI	A 13 DTE	10.10 ->	4	70	---	CSS716
Astra J Sports Tourer 1.4	A 14 XEL	10.10 - 10.15	4	64	CSS706	CSS722
Astra J Sports Tourer 1.4	A 14 XER	10.10 ->	4	74	CSS706	CSS722
Astra J Sports Tourer 1.4 LPG	A 14 NET	01.12 ->	4	103	CSS700	CSS722
Astra J Sports Tourer 1.4 Turbo	A 14 NEL, B 14 NEL	10.10 ->	4	88	CSS700	CSS722
Astra J Sports Tourer 1.4 Turbo	A 14 NET, B 14 NET (01.15-.)	10.10 ->	4	103	CSS700	CSS722
Astra J Sports Tourer 1.6	A 16 XER, B 16 XER	10.10 ->	4	85	CSS719	CSS721
Astra J Sports Tourer 1.6 LPG	A 16 XER	10.12 ->	4	84	CSS719	CSS721
Astra J Sports Tourer 1.6 Turbo	A 16 LET	10.10 ->	4	132	---	CSS715
Astra J Sports Tourer 1.7 CDTI	A 17 DTC, A 17 DTE, A 17 DTJ	10.10 ->	4	81	---	CSS722
Astra J Sports Tourer 1.7 CDTI	A 17 DTF, A 17 DTS	10.10 ->	4	96	---	CSS722
Astra J Sports Tourer 1.7 CDTI	A 17 DTL, A 17 DTN	10.10 ->	4	74	---	CSS722
Astra J Sports Tourer 2.0 CDTI	A 20 DTH	08.11 ->	4	121	CSS1300	CSS1301
Astra J Sports Tourer 2.0 CDTI	A 20 DTH	10.10 ->	4	118	CSS1300	CSS1301
Calibra A 2.0 i	C 20 NE	06.90 - 07.97	4	85	CSS707	---
Calibra A 2.0 i	C 20 NE	06.90 - 07.97	4	85	CSS714	---
Calibra A 2.0 i	C 20 NE	06.90 - 07.97	4	85	CSS707	---
Calibra A 2.0 i	C 20 NE	06.90 - 07.97	4	85	CSS714	---
Calibra A 2.0 i 16V	X 20 XEV	02.94 - 07.97	4	100	CSS702	CSS712
Calibra A 2.0 i 16V	X 20 XEV	02.94 - 07.97	4	100	CSS711	CSS701
Calibra A 2.0 i 16V	X 20 XEV	02.94 - 07.97	4	85	CSS702	CSS712
Calibra A 2.0 i 16V	X 20 XEV	02.94 - 07.97	4	85	CSS711	CSS701
Cascada 1.4	A 14 NEL	03.15 ->	4	88	---	CSS722
Cascada 1.4 Turbo	A 14 NET	03.15 ->	4	103	---	CSS722
Combo 1.3 16V CDTI	Z 13 DT	08.05 ->	4	51	---	CSS716
Combo 1.4 16V	Z 14 XEP	08.05 ->	4	66	---	CSS718
Combo Tour 1.3 16V CDTI	Y 13 DT, Z 13 DT	10.04 ->	4	51	---	CSS716
Combo Tour 1.3 CTDI	A 13 FD	02.12 ->	4	66	---	CSS716
Combo Tour 1.4	Z 14 XEP	10.04 ->	4	66	---	CSS720
Combo Tour 1.6 CDTI	A 16 FDH	02.12 ->	4	74	CSS1300	---
Combo Tour 1.6 CDTI	A 16 FDH	02.12 ->	4	77	CSS1300	---
Combo Tour 1.6 CDTI	A 16 FDL	02.12 ->	4	66	CSS1300	---
Combo Tour 2.0 CDTI	A 20 FD	02.12 ->	4	99	CSS1300	---
Corsa B 1.0 i 12V	Z 14 XEP	11.96 - 09.00	3	40	CSS713	---
Corsa B 1.0 i 12V	Z 14 XEP	11.96 - 09.01	4	85	CSS713	---
Corsa B 1.2 i	C 12 NZ, X 12 SZ	03.93 - 09.00	4	33	CSS703	---
Corsa B 1.2 i	C 12 NZ, X 12 SZ	03.93 - 09.01	4	85	CSS703	---
Corsa B 1.2 i 16V	X 10 XE	03.98 - 09.00	4	48	CSS713	---
Corsa B 1.2 i 16V	X 10 XE	03.98 - 09.01	4	85	CSS713	---

Typ Type	Motornummer Engine-No.	Baujahr Year	Zyl. Cyl.	KW	Kurbelwellen- sensor Crankshaft S.	Nocken- wellensensor Camshaft S.
Corsa B 1.4 i 16V	X 14 XE	09.94 - 09.00	4	66	CSS704	---
Corsa B 1.4 i 16V	X 14 XE	09.94 - 09.01	4	85	CSS704	---
Corsa B 1.4 Si	C 14 SE	03.93 - 09.00	4	60	CSS703	---
Corsa B 1.4 Si	C 14 SE	03.93 - 09.01	4	85	CSS703	---
Corsa B 1.4i 16V	X 14 XE	09.94 - 09.00	4	66	---	CSS700
Corsa B 1.4i 16V	X 14 XE	09.94 - 09.01	4	85	---	CSS700
Corsa B 1.6 GSI 16V	C 16 XE	03.93 - 09.00	4	80	CSS704	CSS700
Corsa B 1.6 GSI 16V	C 16 XE	03.93 - 09.01	4	85	CSS704	CSS700
Corsa B 1.6 i 16V	X 16 XE	09.94 - 09.00	4	78	CSS704	---
Corsa B 1.6 i 16V	X 16 XE	09.94 - 09.00	4	85	CSS704	---
Corsa B 1.6i 16 V	C 16 XE	09.94 - 09.00	4	78	---	CSS700
Corsa B 1.6i 16 V	C 16 XE	09.94 - 09.00	4	85	---	CSS700
Corsa C 1.0	X 12 XE	06.03 - 12.09	3	44	CSS713	---
Corsa C 1.0	X 12 XEP	06.03 - 12.09	4	85	CSS713	---
Corsa C 1.0	Z 10 XE	09.00 - 12.09	3	43	CSS713	CSS718
Corsa C 1.0	Z 10 XEP	06.03 - 12.09	3	44	CSS713	CSS718
Corsa C 1.0	Z 10 XEP	09.00 - 12.09	4	85	CSS713	---
Corsa C 1.2	Z 10 XE	09.00 - 12.09	4	55	CSS713	---
Corsa C 1.2	Z 10 XE	09.00 - 12.07	4	85	CSS713	---
Corsa C 1.2	Z 12 XE	09.00 - 10.09	4	55	CSS713	CSS718
Corsa C 1.2 16V	Z 12 XE	09.00 - 12.09	4	85	CSS713	---
Corsa C 1.2 Twinport	Z 12 XEP	07.04 - 12.09	4	59	---	CSS721
Corsa C 1.2 Twinport	Z 12 XEP	07.04 - 12.09	4	59	CSS713	CSS718
Corsa C 1.3 16V CDTI	Z 13 DT	08.05 - 12.09	4	51	---	CSS716
Corsa C 1.3 CDTI	Z 13 DT	06.03 - 12.09	4	51	---	CSS716
Corsa C 1.4 Twinport	Z 14 XEP	06.03 - 12.09	4	66	---	CSS721
Corsa C 1.4 Twinport	Z 14 XEP	06.03 - 12.09	4	66	CSS713	CSS718
Corsa D 1.0	A 10 XEP	01.10 ->	3	48	CSS706	---
Corsa D 1.0	Z 10 XEP	07.06 ->	3	44	CSS713	CSS721
Corsa D 1.2	A 12 XEL	06.10 ->	4	51	CSS706	CSS722
Corsa D 1.2	A 12 XER	06.10 ->	4	63	CSS706	CSS722
Corsa D 1.2	Z 12 XEP	07.06 ->	4	59	CSS713	---
Corsa D 1.2	Z 12 XEP	07.06 ->	4	59	---	CSS716
Corsa D 1.2 LPG	A 12 XER	06.11 ->	4	61	CSS706	CSS722
Corsa D 1.2 LPG	A 12 XER	08.11 ->	4	63	CSS706	CSS722
Corsa D 1.2 LPG	Z 12 XEP	09.09 ->	4	59	CSS713	---
Corsa D 1.3 CDTI	A 13 DTC, Z 13 DTJ	07.06 ->	4	55	---	CSS716
Corsa D 1.3 CDTI	Z 13 DTH	07.06 ->	4	66	---	CSS716
Corsa D 1.3 CTDI	A 13 DTR, Z 13 DTE, A 13 DTE	06.10 ->	4	70	---	CSS716
Corsa D 1.4	A 14 NEL	07.12 ->	4	88	CSS700	CSS722
Corsa D 1.4	A 14 XER	06.10 ->	4	74	CSS706	CSS722
Corsa D 1.4	A 14 XEL	09.09 ->	4	64	CSS706	CSS722
Corsa D 1.4 LPG	A 14 XEL	09.09 ->	4	64	CSS706	CSS722
Corsa D 1.4 LPG	Z 14 XEP	07.06 ->	4	66	CSS713	---
Corsa D 1.6 Turbo	A 16 LES	06.11 ->	4	155	---	CSS720
Corsa D 1.6 Turbo	B 16 LER, A 16 LER, Z 16 LER	02.07 ->	4	141	---	CSS720
Corsa D 1.6 Turbo	Z 16 LEL, A 16 LEL	02.07 ->	4	110	---	CSS720
Corsa D 1.7 CDTI	A 17 DTS	06.10 ->	4	96	CSS706	CSS722
Corsa D Van 1.0	A 10 XEP	01.10 ->	3	48	CSS706	---
Corsa D Van 1.0	A 10 XEP	07.06 ->	3	44	---	CSS721
Corsa D Van 1.2	A 12 XEL	06.10 ->	4	51	CSS706	CSS722
Corsa D Van 1.2	A 12 XER	06.10 ->	4	63	CSS706	CSS722
Corsa E 1.6 Turbo	B 16 LES	03.15 ->	4	152	---	CSS715
Frontera A Sport 2.0 i	C 20 NE	03.92 - 10.98	4	85	CSS707	---
Frontera A Sport 2.0 i	C 20 NE	03.92 - 10.99	4	85	CSS707	---
Frontera B 2.2 DTI	X 22 DTH, Y 22 DTH	10.98 - 09.02	4	85	CSS709	---
Frontera B 2.2 DTI	X 22 DTH, Y 22 DTH	10.98 - 09.03	4	85	CSS709	---
Insignia 1.6	A 16 XER	07.08 ->	4	85	CSS719	---
Insignia 1.6 Turbo	A 16 LET	07.08 ->	4	132	---	CSS720

Typ Type	Motornummer Engine-No.	Baujahr Year	Zyl. Cyl.	KW	Kurbelwellen- sensor Crankshaft S.	Nocken- wellensensor Camshaft S.
Insignia 2.0 Biturbo CDTI	A 20 DTR	01.12 ->	4	143	CSS1300	---
Insignia 2.0 Biturbo CDTI	A 20 DTR	07.08 ->	4	140	CSS1300	CSS1301
Insignia 2.0 CDTI	A 20 DT, A 20 DTJ	07.08 ->	4	96	CSS1300	CSS1301
Insignia 2.0 CDTI	A 20 DTC, A 20 DTL	07.08 ->	4	81	CSS1300	CSS1301
Insignia 2.0 CDTI	A 20 DTE	03.12 ->	4	88	CSS1300	---
Insignia 2.0 CDTI	A 20 DTE	07.13 ->	4	103	CSS1300	---
Insignia 2.0 CDTI	A 20 DTH	07.13 ->	4	120	CSS1300	---
Insignia 2.0 CDTI	A 20 DTH	07.08 ->	4	118	CSS1300	CSS1301
Insignia A 1.4	A 14 NET, B 14 NET	04.11 ->	4	103	CSS700	CSS722
Insignia A 1.4 LPG	A 14 NET	07.12 ->	4	103	CSS700	CSS722
Insignia A 1.6	A 16 XER	07.08 ->	4	85	---	CSS715
Insignia A 1.6	A 16 XER	07.08 ->	4	85	---	CSS721
Insignia A 1.8	A 18 XER	07.08 ->	4	103	---	CSS715
Insignia A 1.8	A 18 XER	07.08 ->	4	103	---	CSS721
Insignia A Estate 1.4	A 14 NET	09.11 ->	4	103	CSS700	CSS722
Insignia A Estate 1.4 LPG	A 14 NET	07.12 ->	4	103	CSS700	CSS722
Insignia A Estate 1.6	A 16 XER	07.08 ->	4	85	---	CSS715
Insignia A Estate 1.6	A 16 XER	07.08 ->	4	85	---	CSS721
Insignia A Estate 1.8	A 18 XER	07.08 ->	4	103	---	CSS715
Insignia A Estate 1.8	A 18 XER	07.08 ->	4	103	---	CSS721
Insignia A Saloon 1.4	A 14 NET, B 14 NET	04.11 ->	4	103	CSS700	CSS722
Insignia A Saloon 1.4 LPG	A 14 NET	07.12 ->	4	103	CSS700	CSS722
Insignia A Saloon 1.6	A 16 XER	07.08 ->	4	85	---	CSS715
Insignia A Saloon 1.6	A 16 XER	07.08 ->	4	85	---	CSS721
Insignia A Saloon 1.8	A 18 XER	07.08 ->	4	103	---	CSS715
Insignia A Saloon 1.8	A 18 XER	07.08 ->	4	103	---	CSS721
Insignia Caravan 1.6 Turbo	A 16 LET	01.09 ->	4	132	---	CSS720
Insignia Sports Tourer 2.0 Biturbo CDTI	A 20 DTR	01.12 ->	4	143	CSS1300	---
Insignia Sports Tourer 2.0 CDTI	A 20 DTE	03.12 ->	4	88	CSS1300	---
Insignia Sports Tourer 2.0 CDTI	A 20 DTE	07.13 ->	4	103	CSS1300	---
Insignia Sports Tourer 2.0 CDTI	A 20 DTH	07.13 ->	4	120	CSS1300	---
Insignia Stufenheck 1.6 Turbo	A 16 LET	01.09 ->	4	132	---	CSS720
Kadett E CC 2.0 GSI 16V	20XE	12.87 - 08.91	4	115	CSS707	---
Kadett E CC 2.0 GSI 16V	20XE	12.87 - 08.92	4	85	CSS707	---
Meriva 1.6 Turbo	Z 16 LET	09.05 - 05.10	4	132	---	CSS720
Meriva A 1.4 16V Twinport	Z 14 XEP	07.04 - 05.10	4	66	CSS713	CSS718
Meriva A 1.4 16V Twinport	Z 14 XEP	07.04 ->	4	85	CSS713	---
Meriva A 1.6	Z 16 XEP	01.06 - 05.10	4	77	---	CSS717
Meriva B 1.3 CDTI	A 13 DTC	06.10 ->	4	55	---	CSS716
Meriva B 1.3 CDTI	A 13 DTE	06.10 ->	4	70	---	CSS716
Meriva B 1.4	A 14 NEL, B 14 NEL	06.10 ->	4	88	CSS700	CSS722
Meriva B 1.4	A 14 NET, B 14 NET	06.10 ->	4	103	CSS700	CSS722
Meriva B 1.4	A 14 XER, B 14 XER	06.10 ->	4	74	CSS700	CSS722
Meriva B 1.4 LPG	A 14 NEL, B 14 NEL	06.11 ->	4	88	CSS700	CSS722
Meriva B 1.7 CDTI	A 17 DT	06.10 ->	4	74	---	CSS722
Meriva B 1.7 CDTI	A 17 DTC, A 17 DTI	06.10 ->	4	81	---	CSS722
Meriva B 1.7 CDTI	A 17 DTS	06.10 ->	4	96	---	CSS722
Mervia A 1.3 CDTI	Y 13 DT, Z 13 DT	04.05 - 05.10	4	51	---	CSS716
Mervia A 1.3 CDTI	Z 13 DTJ	09.03 - 05.10	4	55	---	CSS716
Mokka 1.6	A 16 XER, B 16 XER	06.12 ->	4	85	CSS719	---
Mokka X 1.4	A 14 NET, B 14 NET (01.15-)	04.13 ->	4	103	CSS700	CSS722
Mokka X 1.4 4x4	A 14 NET, B 14 NET (01.15-)	06.12 ->	4	103	CSS700	CSS722
Mokka X 1.4 LPG	A 14 NET, B 14 NET	04.13 ->	4	103	CSS700	CSS722
Mokka X 1.6	A 16 XER, B 16 XER	06.12 ->	4	85	---	CSS715
Mokka X 1.6	A 16 XER, B 16 XER	06.12 ->	4	85	---	CSS721
Mokka X 1.7 CDTI	A 17 DTS	06.12 ->	4	96	CSS700	CSS722
Mokka X 1.7 CDTI 4x4	A 17 DTS	06.12 ->	4	96	CSS700	CSS722
Omega A 1.8	18 SEH	09.86 - 03.94	4	85	CSS707	---
Omega A 1.8	19 SEH	09.86 - 03.95	4	85	CSS707	---

Typ Type	Motornummer Engine-No.	Baujahr Year	Zyl. Cyl.	KW	Kurbelwellen- sensor Crankshaft S.	Nocken- wellensensor Camshaft S.
Omega A 1.8	E 18 NVR	09.87 - 03.94	4	65	CSS707	---
Omega A 1.8 N	18 NV	09.86 - 08.87	4	60	CSS707	---
Omega A 1.8 S	18 SV	09.86 - 03.94	4	66	CSS707	---
Omega A 2.0	20 SE	09.86 - 03.94	4	90	CSS707	---
Omega A 2.0 i	C 20 NE	09.86 - 03.94	4	85	CSS707	---
Omega A 3.0 24V	C 30 SE	09.89 - 03.94	6	150	CSS704	---
Omega B 2.0	X 20 SE	03.94 - 09.99	4	85	CSS714	---
Omega B 2.0 16 V	X 20 XEV	03.94 - 09.99	4	100	CSS702	CSS712
Omega B 2.0 16 V	X 20 XEV	03.94 - 09.99	4	100	CSS711	CSS701
Omega B 2.0 DTI 16V	X 20 DTH	09.97 - 09.00	4	74	CSS709	---
Omega B 2.2 DTI 16V	Y 22 DTH	09.00 - 07.03	4	88	CSS709	---
Senator B 3.0 24V	C 30 SE	09.89 - 09.93	6	150	CSS704	---
Signum 1.8	Z 18 XER	09.05 ->	4	103	---	CSS721
Signum 1.9 CDTI	Z 19 DT	08.05 ->	4	74	CSS1317	---
Signum 1.9 CDTI	Z 19 DT	04.04 ->	4	88	CSS1317	---
Signum 1.9 CDTI	Z 19 DT	08.05 ->	4	84	CSS1317	---
Signum 1.9 CDTI	Z 19 DTH	04.04 ->	4	110	CSS1300	CSS1301
Signum 2.0 DTI	Y 20 DTH	05.03 ->	4	74	CSS709	---
Signum 2.2 DTI	Y 22 DTR	05.03 ->	4	92	CSS709	---
Sintra 2.2 DTI	X 22 DTH	07.97 - 04.99	4	85	CSS709	---
Tigra 1.4 16V	X 14 XE	07.94 - 12.00	4	66	CSS704	CSS700
Tigra 1.6 16V	X 16 XE	07.94 - 08.98	4	78	CSS704	---
Tigra 1.6 16V	X 16 XE	07.94 - 08.98	4	78	---	CSS700
Tigra TwinTop 1.3 CDTI	Z 13 DT	06.04 ->	4	51	---	CSS716
Tigra TwinTop 1.3 CDTI	Z 13 DT	06.04 ->	4	51	CSS1303	---
Tigra TwinTop 1.4	Z 14 XEP	06.04 ->	4	66	---	CSS720
Tigra TwinTop 1.4	Z 14 XEP	06.04 ->	4	66	CSS713	CSS718
Vectra 1.9 CDTI	Z 19 DTH	04.04 ->	4	110	CSS1300	---
Vectra A 1.6 i	X 16 SZ	09.93 - 11.95	4	52	CSS703	---
Vectra A 1.8 i Kat	C 18 NZ	09.86 - 03.94	4	66	CSS707	---
Vectra A 1.8 i KAT	C 18 NZ	03.90 - 11.95	4	66	CSS714	---
Vectra A 1.8 S	18 SV	09.89 - 10.90	4	66	CSS707	---
Vectra A 1.8 S	E 18 NVR	09.88 - 07.89	4	65	CSS707	---
Vectra A 1.8 S 4x4	E 18 NVR	01.89 - 07.89	4	65	CSS707	---
Vectra A 2.0 i	20 NE	09.88 - 10.90	4	85	CSS707	---
Vectra A 2.0 i	20 SEH	09.88 - 09.92	4	95	CSS707	---
Vectra A 2.0 i 16V	X 20 XEV	06.94 - 11.95	4	100	CSS711	CSS701
Vectra A 2.0 i 16V 4x4	X 20 XEV	06.94 - 11.95	4	100	CSS711	CSS701
Vectra A 2.0 i 4x4	20 NE	01.89 - 10.90	4	85	CSS707	---
Vectra A 2.0 i 4x4	20 SEH	01.89 - 09.92	4	95	CSS707	---
Vectra A 2.0 i 4x4 KAT	C 20 NE	01.89 - 11.95	4	85	CSS707	---
Vectra A 2.0 i KAT	C 20 NE	09.88 - 11.95	4	85	CSS707	---
Vectra A 2.0 i KAT	C 20 NE	09.88 - 11.95	4	85	CSS714	---
Vectra A 2.0 i Turbo 4x4	C 20 LET	06.94 - 11.95	4	150	CSS707	---
Vectra A 2000/GT 16V KAT	C 20 XE	02.90 - 11.95	4	110	CSS707	---
Vectra A CC 1.6 i	X 16 SZ	09.93 - 11.95	4	52	CSS703	---
Vectra A CC 1.8 i	18 SV	09.88 - 10.90	4	66	CSS707	---
Vectra A CC 1.8 i KAT	C 18 NZ	03.90 - 11.95	4	66	CSS707	---
Vectra A CC 1.8 i KAT	C 18 NZ	03.90 - 11.95	4	66	CSS714	---
Vectra A CC 1.8 S	E 18 NVR	09.88 - 07.89	4	65	CSS707	---
Vectra A CC 2.0 i	20 NE	09.88 - 10.90	4	85	CSS707	---
Vectra A CC 2.0 i 16V	X 20 XEV	06.94 - 11.95	4	100	CSS711	CSS701
Vectra C 1.6	Z 16 XEP	01.06 ->	4	77	---	CSS717
Vectra C 1.8	Z 18 XER	01.06 ->	4	103	---	CSS721
Vectra C Estate 1.8	Z 18 XER	01.06 ->	4	103	---	CSS721
Vectra C GTS 1.6	Z 16 XEP	01.06 ->	4	77	---	CSS717
Vectra C GTS 1.9 CDTI	Z 19 DT	04.04 ->	4	88	CSS1317	---
Vectra C GTS 1.9 CDTI	Z 19 DT	10.05 ->	4	84	CSS1317	---
Vectra C GTS 1.9 CDTI	Z 19 DT	04.04 ->	4	84	CSS1317	---

Typ Type	Motornummer Engine-No.	Baujahr Year	Zyl. Cyl.	KW	Kurbelwellen- sensor Crankshaft S.	Nocken- wellensensor Camshaft S.
Vectra C1.9 CDTI	Z 19 DT	10.05 ->	4	74	CSS1317	---
Vectra C1.9 CDTI	Z 19 DT	04.04 ->	4	88	CSS1317	---
Vectra C1.9 CDTI	Z 19 DT	10.05 ->	4	84	CSS1317	---
Vectra C1.9 CDTI	Z 19 DT	04.04 ->	4	84	CSS1317	---
Zafira B 1.6	Z 16 XE1, Z 16 XEP	07.05 ->	4	77	---	CSS717
Zafira B 1.6 CNG Turbo	A 16 XNT, Z 16 XNT	02.09 ->	4	110	---	CSS720
Zafira B 1.8	A 18 XER, Z 18 XER	07.05 ->	4	103	---	CSS721
Zafira B 1.9 CDTI	Z 19 DT	07.05 ->	4	88	CSS1317	---
Zafira B 1.9 CDTI	Z 19 DT	07.05 ->	4	74	CSS1317	---
Zafira B 1.9 CDTI	Z 19 DT	07.05 ->	4	84	CSS1317	---
Zafira B 1.9 CDTI	Z 19 DT	07.05 ->	4	84	CSS1317	---
Zafira B Van 1.6 CNG Turbo	A 16 XNT, Z 16 XNT	02.09 ->	4	110	---	CSS720
Zafira B Van 1.8	A 18 XER, Z 18 XER	07.05 ->	4	103	---	CSS721
Zafira Tourer C 1.4	A 14 NEL, B 14 NEL	10.11 ->	4	88	CSS700	CSS722
Zafira Tourer C 1.4	A 14 NET, B 14 NET	10.11 ->	4	103	CSS700	CSS722
Zafira Tourer C 1.4 LPG	A 14 NET, B 14 NET	10.11 ->	4	103	CSS700	CSS722
Zafira Tourer C 1.6 CNG	A 16 XNT, B 16 XNT	10.11 ->	4	110	---	CSS720
Zafira Tourer C 1.8	A 18 XEL	10.11 ->	4	85	---	CSS715
Zafira Tourer C 1.8	A 18 XEL	10.11 ->	4	85	---	CSS721
Zafira Tourer C 1.8	A 18 XEL	10.11 ->	4	85	CSS719	---
Zafira Tourer C 1.8	A 18 XER	10.11 ->	4	103	---	CSS715
Zafira Tourer C 1.8	A 18 XER	10.11 ->	4	103	---	CSS721
Zafira Tourer C 1.8 LPG	A 18 XER	10.11 ->	4	101	---	CSS721
Zafira Tourer C 2.0 BiTurbo CDTI	A 20 DTR	01.13 ->	4	143	CSS1300	---
Zafira Tourer C 2.0 CDTi	A 20 DT, Z 20 DTJ, Y 20 DTJ	10.11 ->	4	96	CSS1300	---
Zafira Tourer C 2.0 CDTi	A 20 DTH	10.11 ->	4	118	CSS1300	---
Zafira Tourer C 2.0 CDTi	A 20 DTH	10.11 ->	4	121	CSS1300	---
<b>Peugeot</b>						
106 I 1.0	CDY (TU9M)	09.91 - 04.96	4	33	CSS1502	---
106 I 1.1	HDZ (TU1M)	09.91 - 04.96	4	44	CSS1502	---
106 I 1.3	TU2J2	10.93 - 04.96	4	72	CSS1502	---
106 I 1.4	KDX (TU3MC), KDY (TU3M)	09.91 - 04.96	4	55	CSS1502	---
106 I 1.4 D	K9Y (TUD3Y)	09.92 - 04.96	4	37	CSS1505	---
106 I 1.5 D	VJY (TUD5)	06.94 - 04.96	4	40	CSS1505	---
106 I 1.6	NFY (TU5J2)	01.94 - 04.96	4	76	CSS1502	---
106 I 1.6	NFZ (TU5JP)	06.93 - 04.96	4	65	CSS1502	---
106 II 1.0i	CDY (TU9M)	05.96 ->	4	33	CSS1502	---
106 II 1.0i	CDY (TU9M)	05.96 ->	4	33	CSS1508	---
106 II 1.0i	CDZ (TU9M)	01.97 ->	4	37	CSS1502	---
106 II 1.0i	CDZ (TU9M)	01.97 ->	4	37	CSS1508	---
106 II 1.1i	HDY (TU1M)	01.97 ->	4	40	CSS1502	---
106 II 1.1i	HDY (TU1M)	01.97 ->	4	40	CSS1508	---
106 II 1.1i	HDZ (TU1M), HFX (TU1JP)	05.96 ->	4	44	CSS1502	---
106 II 1.1i	HDZ (TU1M), HFX (TU1JP)	05.96 ->	4	44	CSS1508	---
106 II 1.4i	KFW (TU3JP), KFX (TU3JP)	05.96 ->	4	55	CSS1508	CSS1503
106 II 1.5 D	VJX (TUD5)	04.98 ->	4	42	CSS1505	---
106 II 1.5 D	VJY (TUD5)	05.96 ->	4	40	CSS1505	---
106 II 1.6 S16	NFX (TU5J4)	05.96 ->	4	87	CSS1507	---
106 II 1.6i	NFW (TU5J2), NFY (TU5J2)	05.96 ->	4	74	CSS1502	---
106 II 1.6i	NFW (TU5J2), NFY (TU5J2)	05.96 ->	4	74	CSS1508	---
106 II 1.6i	NFZ (TU5JP)	05.96 ->	4	65	CSS1502	---
106 II 1.6i	NFZ (TU5JP)	05.96 ->	4	65	CSS1508	---
107 1.4 HDI	8HT (DV4TD)	06.05 ->	4	40	CSS1517	CSS1519
108 1.0 VTi	1KR-FE	05.14 ->	3	51	CSS1548	---
108 1.2	HMT (EB2D)	05.14 ->	3	60	CSS1548	---
205 I Cabriolet 1.1 CJ	HDZ (TU1M)	10.89 - 12.94	4	44	CSS1502	---
205 I Cabriolet 1.4 CJ	KDY (TU3M), KDZ (TU3M)	05.91 - 12.94	4	55	CSS1502	---
205 II 1.0	TU9	10.87 - 09.98	4	33	CSS1502	---

Typ Type	Motornummer Engine-No.	Baujahr Year	Zyl. Cyl.	KW	Kurbelwellen- sensor Crankshaft S.	Nocken- wellensensor Camshaft S.
205 II 1.1	HDZ (TU1M)	07.89 - 09.98	4	44	CSS1502	---
205 II 1.4	KDY (TU3M), KDZ (TU3M)	07.88 - 09.98	4	55	CSS1502	---
205 II 1.7 Diesel	161A (XUD7)	07.87 - 09.98	4	44	CSS1504	---
206 1.1i	HFX (TU1JP), HFZ (TU1JP)	09.98 ->	4	44	CSS1518	---
206 1.4 HDi eco 70	8HZ (DV4TD)	09.08 ->	4	50	CSS1517	CSS1519
206 1.4 HDi eco 70	8HZ (DV4TD), 8HX (DV4TD)	01.09 ->	4	50	CSS1517	CSS1519
206 1.4 i	KFT (TU3A)	09.10 ->	4	54	CSS1518	---
206 1.4i	KFW (TU3JP), KFX (TU3JP)	09.98 ->	4	55	CSS1518	---
206 1.6 16V	NFU (TU5JP4)	12.00 ->	4	80	CSS1518	---
206 1.6 HDI 110	9HY (DV6TED4), 9HZ (DV6TED4)	05.04 ->	4	80	CSS1517	CSS1510
206 1.9 D	WJZ (DW8)	09.98 - 11.01	4	51	CSS1505	---
206 2.0 HDI 90	RHY (DW10TD)	12.99 ->	4	66	CSS1513	CSS1510
206 2.0 HDI 90	RHY (DW10TD)	12.99 ->	4	66	CSS1522	---
206 2.0 RC	RFK (EW10J4S)	07.03 ->	4	130	CSS1522	CSS1511
206 2.0 S16	RFN (EW10J4)	10.00 ->	4	100	CSS1513	CSS1511
206 2.0 S16	RFN (EW10J4)	06.99 ->	4	100	CSS1513	---
206 2.0 S16	RFN (EW10J4)	06.99 ->	4	100	CSS1522	---
206 2.0 S16	RFR (DEW10J4)	04.99 - 10.00	4	99	CSS1513	---
206 CC 2.0 S16	RFN (EW10J4)	09.00 ->	4	100	CSS1522	---
206+ 1.4 HDI eco 70	8HX (DV4TD), 8HZ (DV4TD)	01.09 ->	4	50	CSS1538	CSS1519
207 1.4	KFV (TU3A)	02.06 ->	4	53	CSS1518	---
207 1.4 16V	8FR (EP3)	10.09 ->	4	72	CSS1545	CSS920
207 1.4 16V	8FS (EP3), EP3, EP3C	06.07 ->	4	70	CSS1545	CSS920
207 1.4 16V	KFU (ET3J4)	02.06 ->	4	65	CSS1518	---
207 1.4 HDi	8HR (DV4C), 8HZ (DV4TD)	02.06 ->	4	50	---	CSS1519
207 1.6 16V	NFU (TU5JP4)	02.06 ->	4	80	CSS1518	---
207 1.6 16V	NFU (TU5JP4)	02.06 ->	4	80	CSS1538	---
207 1.6 16V RC	5FY (EP6DTS)	02.07 ->	4	128	CSS1545	CSS920
207 1.6 16V Turbo	5FR (EP6DT)	10.09 ->	4	115	CSS1545	CSS920
207 1.6 16V Turbo	5FX (EP6DT)	02.06 ->	4	110	CSS1545	CSS920
207 1.6 16V VTi	5FS (EP6C), 5FW (EP6), EP6	02.07 ->	4	88	CSS1545	CSS920
207 1.6 16V VTi	EP6	02.07 ->	4	88	CSS912	---
207 1.6 HDi	9HP (DV6DTED)	11.09 ->	4	68	CSS1547	---
207 1.6 HDI	9HX (DV6ATED4)	02.06 ->	4	66	---	CSS1510
207 1.6 HDi	9HX (DV6ATED4)	02.06 ->	4	66	CSS1538	---
207 1.6 HDI	9HY (DV6TED4), 9HZ (DV6TED4)	02.06 ->	4	80	---	CSS1510
207 1.6 HDi	9HY (DV6TED4), 9HZ (DV6TED4)	02.06 ->	4	80	CSS1538	---
207 1.6 HDi 110	9HR (DV6C)	08.09 ->	4	82	CSS1547	---
207 CC 1.6 16V	5FS (EP6C), 5FW (EP6), EP6	02.07 ->	4	88	CSS1545	CSS920
207 CC 1.6 16V Turbo	5FR (EP6DT), 5FV (EP6CDT)	10.09 ->	4	115	CSS1545	---
207 CC 1.6 16V Turbo	5FX (EP6DT)	02.07 ->	4	110	---	CSS920
207 CC 1.6 16V Turbo	EP6CDT, 5FR (EP6DT)	10.09 ->	4	115	---	CSS920
207 CC 16V Turbo	5FX (EP6DT)	02.07 ->	4	110	CSS1545	---
207 SW 1.4 16V	8FR (EP3)	11.09 ->	4	72	CSS1545	CSS920
207 SW 1.4 16V	8FS (EP3), EP3, EP3C	06.07 ->	4	70	CSS1545	---
207 SW 1.4 16V	EP3C, 8FS (EP3), EP3	06.07 ->	4	70	---	CSS920
207 SW 1.6 16V	5FS (EP6C), 5FW (EP6), EP6	06.07 ->	4	88	CSS1545	CSS920
207 SW 1.6 16V RC	5FY (EP6DTS)	02.07 ->	4	128	---	CSS920
207 SW 1.6 16V Turbo	5FX (EP6DT)	02.07 ->	4	110	CSS1545	---
207 SW 1.6 HDi	9HP (DV6DTED)	11.09 ->	4	68	CSS1547	---
207 SW 1.6 HDi	9HR (DV6C)	08.09 ->	4	82	CSS1547	---
208 .16 HDi	9HP (DV6DTED)	03.12 ->	4	68	CSS1547	---
208 1.0	ZMZ (EB0)	03.12 ->	3	50	CSS1548	---
208 1.2	HMZ (EB2F)	03.12 ->	3	60	CSS1548	---
208 1.2 GPL	HMZ (EB2F)	06.15 ->	3	60	CSS1548	---
208 1.2 THP	HNZ (EB2DT)	01.13 ->	3	81	CSS1548	---
208 1.4	EP3C, 8FS (EP3)	03.12 ->	4	70	CSS912	---
208 1.4 HDi	8HR (DV4C), 8HP (DV4C)	03.12 ->	4	50	CSS1538	---
208 1.4 VTi	8FS (EP3), EP3C	03.12 ->	4	70	CSS1545	CSS920

Typ Type	Motornummer Engine-No.	Baujahr Year	Zyl. Cyl.	KW	Kurbelwellen- sensor Crankshaft S.	Nocken- wellensensor Camshaft S.
208 1.6	5FS (EP6C)	03.12 ->	4	88	CSS1545	CSS920
208 1.6	5FV (EP6CDT)	03.12 ->	4	115	CSS1545	---
208 1.6	EP6CDT, 5FV (EP6DT)	03.12 ->	4	115	CSS912	CSS920
208 1.6 BlueHDi 100	BHY (DV6FD)	01.15 ->	4	73	CSS1547	---
208 1.6 BlueHDi 120	BHZ (DV6FC)	11.13 ->	4	88	CSS1547	---
208 1.6 GTi	5FU (EP6CDTX)	08.12 ->	4	147	CSS1545	CSS920
208 1.6 GTi	---	10.14 ->	4	153	---	CSS920
208 1.6 HDi	9HD (DV6CTED)	03.12 ->	4	84	CSS1547	---
208 1.6 HDi	BHX (DV6FC)	04.14 ->	4	85	CSS1547	---
208 1.6 HDi/BlueHDi 75	9HK (DV6ETEDM), BHW (DV6FE)	01.13 ->	4	55	CSS1547	---
208 1.6 THP 165	---	03.15 ->	4	121	---	CSS920
301 1.2 VTi 72	HMY (EB2M)	11.12 ->	3	53	CSS1548	---
301 1.2 VTi 82	---	12.14 ->	3	60	CSS1548	---
301 1.6 HDi 90	9HF (DV6DTEd)	11.12 ->	4	68	CSS1547	---
301 1.6 VTi 115	NFP (EC5)	11.13 ->	4	85	CSS1518	---
306 1.1	HDZ (TU1M)	06.94 - 05.01	4	44	CSS1502	---
306 1.4	KDX (TU3MC), KFW (TU3JP)	05.93 - 05.01	4	55	CSS1518	CSS1503
306 1.4 SL	KDX (TU3MC), KFW (TU3JP)	06.94 - 05.01	4	55	CSS1518	CSS1503
306 1.6	NFT	10.00 - 05.01	4	72	CSS1518	---
306 1.6 SR	NFZ (TU5JP)	06.94 - 10.00	4	65	CSS1507	---
306 1.8	LFZ (XU7JP)	05.93 - 05.01	4	74	CSS1501	---
306 1.8 16V	LFY (XU7JP4)	03.97 - 05.01	4	81	CSS1501	CSS1509
306 1.8 D	A9A (XUD7)	05.93 - 05.01	4	43	CSS1504	---
306 1.8 ST	LFZ (XU7JP)	06.94 - 05.01	4	74	CSS1501	---
306 1.9 D	DHV (XUD9BSD)	03.98 - 05.01	4	55	CSS1501	---
306 1.9 D	WJY (DW8B), WYZ (DW8)	09.98 - 05.01	4	51	CSS1504	---
306 1.9 D	WJY (DW8B), WYZ (DW8)	09.98 - 05.01	4	51	CSS1514	---
306 1.9 SLD	DJY (XUD9A)	06.94 - 05.01	4	50	CSS1504	---
306 1.9 SLD	DJZ (XUD9Y)	06.94 - 05.01	4	47	CSS1504	---
306 1.9 SRDT	DHY (XUD9TE)	06.94 - 05.01	4	66	CSS1504	---
306 2.0	RFV (XU10J4R)	03.97 - 05.01	4	97	CSS1501	---
306 2.0 HDi 90	RHY (DW10TD)	06.99 - 05.01	4	66	CSS1514	CSS1510
306 2.0 S16	RFT (XU10J4)	06.94 - 05.01	4	110	CSS1501	CSS1503
306 2.0 S16	RFY (XU10J4Z)	06.94 - 05.01	4	112	CSS1501	CSS1503
306 2.0 ST	RFX (XU10J2)	07.94 - 05.01	4	89	CSS1501	---
307 1.4	KFW (TU3JP)	08.00 ->	4	55	CSS1518	---
307 1.4 HDi	8HX (DV4TD), 8HZ (DV4TD)	10.01 ->	4	50	CSS1517	CSS1519
307 1.6 16V	NFU (TU5JP4)	03.02 ->	4	80	CSS1518	---
307 1.6 16V	NFU (TU5JP4)	08.00 ->	4	80	CSS1521	---
307 1.6 HDi 110	9HY (DV6TED4)	02.04 ->	4	80	CSS1517	CSS1510
307 2.0 16V	RFJ (EW10A)	03.05 ->	4	103	CSS1522	CSS1511
307 2.0 16V	RFK (EW10J4S)	06.05 ->	4	130	CSS1522	CSS1511
307 2.0 16V	RFN (EW10J4)	08.00 ->	4	100	CSS1513	CSS1511
307 2.0 16V	RFN (EW10J4)	08.00 ->	4	100	CSS1522	---
307 2.0 HDi 110	RHS (DW10ATED)	08.00 ->	4	79	CSS1522	---
307 2.0 HDi 110	RHS (DW10ATED4)	08.00 ->	4	79	CSS1522	CSS1510
307 2.0 HDi 135	RHR (DW10BTED4)	10.03 >	4	100	CSS1539	---
307 2.0 HDi 135	RHR (DW10BTED4)	10.03 ->	4	100	---	CSS1510
307 2.0 HDi 90	RHY (DW10TD)	08.00 ->	4	66	CSS1513	CSS1510
307 2.0 HDi 90	RHY (DW10TD)	08.00 ->	4	66	CSS1522	---
308 1.4 16V	8FR (EP3)	12.09 ->	4	72	CSS1545	CSS920
308 1.4 16V	8FS (EP3), EP3	09.07 ->	4	70	CSS1545	CSS920
308 1.6 16V	5FT (EP6DT)	09.07 ->	4	103	CSS1545	CSS920
308 1.6 16V	5FV (EP6CDT)	10.09 ->	4	115	CSS1545	---
308 1.6 16V	5FW (EP6), EP6	09.07 ->	4	88	CSS1545	---
308 1.6 16V	5FX (EP6DT)	09.07 ->	4	110	CSS1545	CSS920
308 1.6 16V	5FY (EP6DTS)	03.08 ->	4	128	CSS1545	CSS920
308 1.6 16V	EP6	09.07 ->	4	88	CSS912	---
308 1.6 16V	EP6	09.07 ->	4	88	CSS912	---

Typ Type	Motornummer Engine-No.	Baujahr Year	Zyl. Cyl.	KW	Kurbelwellen- sensor Crankshaft S.	Nocken- wellensensor Camshaft S.
308 1.6 16V	EP6, 5FW (EP6)	09.07 ->	4	88	---	CSS920
308 1.6 16V	EP6CDT	10.09 ->	4	115	CSS912	CSS920
308 1.6 BioFlex	NFU (TU5JP4)	04.08 ->	4	80	CSS912	---
308 1.6 GTi	EP6CDTX	07.10 ->	4	147	CSS1545	CSS920
308 1.6 HDi	9HP (DV6DTED)	11.09 ->	4	68	CSS1547	---
308 1.6 HDi	9HZ (DV6TED4)	09.07 ->	4	66	CSS1538	---
308 1.6 HDi	9HZ (DV6TED4)	09.07 ->	4	80	CSS1538	---
308 1.6 HDi	9HP (DV6DTED)	11.09 ->	4	68	CSS1538	---
308 1.6 HDi	9HR (DV6C)	12.09 ->	4	82	CSS1538	---
308 1.6 HDi	9HZ (DV6TED4)	09.07 ->	4	66	CSS1517	CSS1510
308 1.6 HDi	9HZ (DV6TED4)	09.07 ->	4	80	CSS1517	CSS1510
308 2.0 HDi	RHE (DW10CTED4)	10.11 ->	4	110	CSS1539	CSS1510
308 2.0 HDi	RHH (DW10CTED4)	04.12 ->	4	120	CSS1539	CSS1510
308 2.0 HDi	RHR (DW10BTED4)	07.10 ->	4	103	---	CSS1510
308 2.0 HDi	RHR (DW10BTED4)	09.07 ->	4	100	---	CSS1510
308 2.0 HDi	RHR (DW10BTED4)	09.07 ->	4	100	CSS1539	---
308 CC 1.6 16V	5FT (EP6DT)	06.09 ->	4	103	CSS1545	CSS920
308 CC 1.6 16V	5FV (EP6CDT)	06.09 ->	4	115	CSS1545	---
308 CC 1.6 16V	5FX (EP6DT)	06.09 ->	4	110	CSS1545	CSS920
308 CC 1.6 16V	EP6	06.09 ->	4	88	CSS1545	CSS920
308 CC 1.6 16V	EP6CDT	06.09 ->	4	115	---	CSS920
308 CC 1.6 HDi	9HR (DV6C)	06.09 ->	4	82	CSS1547	---
308 CC 1.6 THP	EP6CDTX	10.10 ->	4	147	CSS1545	CSS920
308 II 1.2 THP 110	HNZ (EB2DT)	11.13 ->	3	81	CSS1548	---
308 II 1.2 THP 130	HNY (EB2DTS)	11.13 ->	3	96	CSS1548	---
308 II 1.2 VTi 72	HMZ (EB2F)	09.13 ->	3	60	CSS1548	---
308 II 1.6	5FV (EP6CDT)	09.13 ->	4	115	CSS1545	CSS920
308 II 1.6 BlueHDi 120	BHZ (DV6FC)	11.13 ->	4	88	CSS1547	---
308 II 1.6 GTi	---	08.15 ->	4	184	---	CSS920
308 II 1.6 GTi	5GN (EP6FDTR)	06.15 ->	4	200	CSS1545	CSS920
308 II 1.6 HDi/BlueHDi 115	9HC (DV6C), BHZ (DV6FC)	09.13 ->	4	85	CSS1547	---
308 II 1.6 THP 125	---	09.13 ->	4	92	---	CSS920
308 II 1.6 THP 150	---	03.14 ->	4	110	---	CSS920
308 II 1.6 THP 163	5FM (EP6CDTM)	06.14 ->	4	120	CSS1545	CSS920
308 II 2.0 BlueHDi 150	AHX (DW10FD)	11.13 ->	4	110	CSS1546	---
308 II 2.0 GT HDi 180	AHW (DW10FC)	06.14 ->	4	133	CSS1546	---
308 SW 1.4 16V	8FR (EP3)	12.09 ->	4	72	CSS1545	CSS920
308 SW 1.4 16V	8FS (EP3)	09.07 ->	4	70	---	CSS920
308 SW 1.6 16V	5FT (EP6DT)	09.07 ->	4	103	---	CSS920
308 SW 1.6 16V	5FV (EP6CDT)	10.09 ->	4	115	CSS1545	---
308 SW 1.6 16V	5FX (EP6DT)	09.07 ->	4	110	---	CSS920
308 SW 1.6 16V	5FY (EP6DTS)	03.08 ->	4	128	CSS1545	CSS920
308 SW 1.6 16V	EP6, 5FW (EP6)	09.07 ->	4	88	---	CSS920
308 SW 1.6 16V	EP6CDT	10.09 ->	4	115	---	CSS920
308 SW 1.6 HDi	9HP (DV6DTED)	11.09 ->	4	68	CSS1547	---
308 SW 1.6 HDi	9HR (DV6C)	12.09 ->	4	82	CSS1547	---
308 SW II 1.2 THP 110	HNZ (EB2DT)	03.14 ->	3	81	CSS1548	---
308 SW II 1.2 THP 130	HNY (EB2DTS)	03.14 ->	3	96	CSS1548	---
308 SW II 1.6 BlueHDi 100	BHY (DV6FD)	04.14 ->	4	73	CSS1547	---
308 SW II 1.6 BlueHDi 120	BHZ (DV6FC)	03.14 ->	4	88	CSS1547	---
308 SW II 1.6 HDi/BlueHDi 115	9HC (DV6C), BHZ (DV6FC)	03.14 ->	4	85	CSS1547	---
308 SW II 1.6 THP 125	---	03.14 ->	4	92	---	CSS920
308 SW II 1.6 THP 150	---	03.14 ->	4	110	---	CSS920
308 SW II 1.6 THP 155	5FV (EP6CDT)	03.14 ->	4	115	CSS1545	CSS920
308 SW II 1.6 THP 163	---	06.14 ->	4	120	---	CSS920
309 II 1.6	BDY (XU5M2Z), BDY (XU5M3Z)	07.89 - 12.93	4	65	CSS1501	---
405 I 1.6	BDY (XU5M2Z), BDZ (XU5M)	07.87 - 12.92	4	65	CSS1501	---
405 I 1.6	BDZ (XU5M)	10.89 - 12.92	4	66	CSS1501	---
405 II 1.4	KDX (TU3MC)	08.92 - 10.95	4	55	CSS1502	---

Typ Type	Motornummer Engine-No.	Baujahr Year	Zyl. Cyl.	KW	Kurbelwellen- sensor Crankshaft S.	Nocken- wellensensor Camshaft S.
405 II 1.4	KDX (TU3MC)	08.92 - 10.96	4	55	CSS1502	---
405 II 1.6	BDY (XU5M2Z), BFZ (XU5JP)	08.92 - 10.95	4	65	CSS1501	---
405 II 1.8	LFZ (XU7JP)	08.92 - 10.95	4	74	CSS1501	---
405 II 1.9 D	DJY (XUD9A)	06.94 - 10.95	4	50	CSS1504	---
405 II 1.9 D	DJZ (XUD9Y)	08.92 - 10.95	4	47	CSS1504	---
405 II 2.0	RFX (XU10J2)	08.92 - 10.95	4	89	CSS1501	---
405 II 2.0 16V	RFT (XU10J4)	06.94 - 10.95	4	110	CSS1501	CSS1503
405 II 2.0 MI-16	RFY (XU10J4Z)	08.92 - 10.95	4	112	---	CSS1503
405 II 2.0 T 16 X4	RGZ (XU10J4TE/Z)	08.92 - 10.95	4	144	CSS1501	CSS1503
405 II 2.0 X4	RFX (XU10J2)	08.92 - 10.95	4	89	CSS1501	---
405 II MI-16	RFY (XU10J4Z)	08.92 - 10.95	4	112	CSS1501	---
406 1.6	BFZ (XU5JP)	11.95 - 05.04	4	65	CSS1501	---
406 1.8	LFX (XU7JB)	05.97 - 05.04	4	66	CSS1501	---
406 1.8 16V	6FZ (EW7J4)	10.00 - 05.04	4	85	CSS1513	CSS1511
406 1.8 16V	LFY (XU7JP4)	11.95 - 10.00	4	81	CSS1501	CSS1509
406 1.9 TD	DHX (XUD9TE)	01.96 - 05.04	4	66	CSS1501	---
406 1.9 TD	DHY (XUD9TE)	01.96 - 05.04	4	68	CSS1501	---
406 2.0 16 HPI	RLZ (EW10D)	05.01 - 05.04	4	103	CSS1513	---
406 2.0 16V	RFN (EW10J4)	08.00 - 05.04	4	100	CSS1513	CSS1511
406 2.0 16V	RFR (DEW10J4)	01.99 - 08.00	4	99	CSS1513	---
406 2.0 16V	RFV (XU10J4R)	11.95 - 05.04	4	97	CSS1501	---
406 2.0 16V HPI	RLZ (EW10D)	05.01 - 05.04	4	103	CSS1513	CSS1512
406 2.0 Break 16V HPI	RLZ (EW10D)	05.01 - 05.04	4	103	---	CSS1512
406 2.0 HDI 110	RHZ (DW10ATED)	06.98 - 08.01	4	80	CSS1513	CSS1510
406 2.0 HDI 110	RHS (DW10ATED4)	08.01 - 05.04	4	79	CSS1513	---
406 2.0 HDI 90	RHY (DW10TD)	02.99 - 05.04	4	66	CSS1513	CSS1510
406 2.0 Turbo	RGX (XU10J2TE)	04.96 - 05.04	4	108	CSS1501	---
406 2.1 TD 12V	P8C (XUD11BTE)	01.96 - 05.04	4	80	CSS1501	---
406 2.2	3FZ (EW12J4)	07.00 - 05.04	4	116	CSS1515	CSS1511
406 2.2 HDi	4HX (DW12TED4, FAP)	03.00 - 05.04	4	98	CSS1513	---
406 2.2 HDI	4HX (DW12TED4, FAP)	03.00 - 05.04	4	98	CSS1514	CSS1510
406 3.0 24V	XFZ (ES9J4)	10.96 - 05.04	4	140	CSS1501	---
406 3.0 V6	XFX (ES9J4S)	03.00 - 05.04	6	152	CSS1514	CSS1512
407 1.6 HDI 110	9HY (DV6TED4)	05.04 ->	4	80	CSS1517	CSS1510
407 1.8	6FZ (EW7J4)	05.04 ->	4	85	CSS1522	CSS1511
407 1.8 16V	6FY (EW7A)	09.05 ->	4	92	CSS1522	---
407 2.0	RFN (EW10J4)	05.04 ->	4	100	CSS1522	CSS1511
407 2.0 Bioflex	RFJ (EW10A)	09.07 ->	4	103	---	CSS1511
407 2.0 HDI	RHE (DW10CTED4)	02.10 ->	4	110	---	CSS1510
407 2.0 HDI	RHH (DW10CTED4)	07.09 ->	4	120	---	CSS1510
407 2.0 HDi	RHR (DW10BTED4)	08.08 ->	4	103	CSS1539	CSS1510
407 2.0 HDI 135	RHR (DW10BTED4)	05.04 ->	4	100	---	CSS1510
407 2.2	3FZ (EW12J4)	05.04 ->	4	116	CSS1522	CSS1511
407 2.2 16V	3FY (EW12J4)	09.05 ->	4	120	CSS1522	CSS1511
407 2.2 HDI	4HP (DW12BTED4)	06.08 ->	4	120	CSS1517	CSS1510
407 2.2 HDI 170	4HT (DW12BTED4)	05.06 ->	4	125	CSS1517	CSS1510
407 3.0	XFV (ES9A)	05.04 ->	6	155	CSS1522	CSS1512
508 1.6	---	09.11 ->	4	121	---	CSS920
508 1.6	5GZ (EP6FDT)	01.12 ->	4	120	CSS1545	CSS920
508 1.6 BlueHdi 120	BHZ (DV6FC)	03.14 ->	4	88	CSS1547	---
508 1.6 HDi	9HD (DV6CTED)	02.12 ->	4	84	CSS1547	---
508 1.6 HDi	9HL (DV6C), 9HR (DV6C)	11.10 ->	4	82	CSS1547	---
508 1.6 HDi	9HR (DV6C)	11.10 ->	4	82	CSS1538	---
508 1.6 HDi	BHX (DV6FC)	09.14 ->	4	85	CSS1547	---
508 1.6 THP	5FN (EP6CDT)	11.10 ->	4	110	CSS1545	CSS920
508 1.6 THP	5FV (EP6CDT)	11.10 ->	4	115	CSS1545	---
508 1.6 THP	EP6CDT	11.10 ->	4	115	CSS912	CSS920
508 1.6 VTi	5FH (EP6C)	11.10 ->	4	85	CSS1545	CSS920
508 1.6 VTi	5FS (EP6C)	11.10 ->	4	88	CSS1545	CSS920

Typ Type	Motornummer Engine-No.	Baujahr Year	Zyl. Cyl.	KW	Kurbelwellen- sensor Crankshaft S.	Nocken- wellensensor Camshaft S.
508 2.0 BlueHDi 150	AHX (DW10FD)	04.14 ->	4	110	CSS1546	---
508 2.0 BlueHDi 180	AHW (DW10FC)	04.14 ->	4	133	CSS1546	---
508 2.0 HDI	RHH (DW10CTED4)	11.10 ->	4	103	---	CSS1510
508 2.0 HDI	RHH (DW10CTED4)	11.10 ->	4	120	---	CSS1510
508 2.2 HDi	4HL (DW12C)	11.10 ->	4	150	CSS1538	CSS1510
508 SW 1.6	---	02.12 ->	4	121	---	CSS920
508 SW 1.6 BlueHDi 120	BHZ (DV6FC)	03.14 ->	4	88	CSS1547	---
508 SW 1.6 HDi	9HD (DV6CTED)	02.12 ->	4	84	CSS1547	---
508 SW 1.6 HDi	9HL (DV6C), 9HR (DV6C)	11.10 ->	4	82	CSS1547	---
508 SW 1.6 HDi	BHX (DV6FC)	09.14 ->	4	85	CSS1547	---
508 SW 1.6 THP	5FV (EP6CDT)	11.10 ->	4	115	CSS1545	---
508 SW 1.6 THP	5FX (EP6DT)	11.10 ->	4	110	---	CSS920
508 SW 1.6 THP	EP6CDT	11.10 ->	4	115	---	CSS920
508 SW 1.6 VTi	5FH (EP6C)	11.10 ->	4	85	CSS1545	CSS920
508 SW 1.6 VTi	5FS (EP6C)	11.10 ->	4	88	CSS1545	CSS920
508 SW 2.0 BlueHDi 150	AHX (DW10FD)	04.14 ->	4	110	CSS1546	---
508 SW BlueHDi 180	AHW (DW10FC)	04.14 ->	4	133	CSS1546	---
605 2.0	RFZ (XU10J2Z)	06.89 - 09.99	4	89	CSS1501	---
605 2.0 16V	RFV (XU10J4R)	07.94 - 09.99	4	97	CSS1501	---
605 2.0 Turbo	RGX (XU10J2TE)	07.91 - 09.99	4	108	CSS1501	---
605 2.0 Turbo	RGY (XU10J2TE)	07.92 - 09.99	4	104	CSS1501	---
605 2.1 D	P9A (XUD11A)	06.89 - 07.95	4	60	CSS1505	---
605 2.1 TD	PHZ (XUD11ATE)	06.89 - 09.99	4	80	CSS1505	---
605 2.1 TD 12V	P8C (XUD11BTE)	08.94 - 09.99	4	80	CSS1505	---
605 2.1 Turbo Diesel	PHZ (XUD11ATE)	06.89 - 09.99	4	80	CSS1501	---
605 2.5 Turbo Diesel	THY (DK5ATE)	07.94 - 09.99	4	95	CSS1501	---
605 3.0	UFZ (ZPJ)	10.89 - 09.99	6	123	CSS1501	---
605 3.0 SV 24	UKZ (ZPJ4/Z)	08.89 - 09.99	6	147	CSS1501	---
605 3.0 V6	---	04.97 - 09.99	6	140	CSS1501	---
607 2.0	RFN (EW10J4)	02.00 ->	4	100	CSS1515	CSS1511
607 2.0	RFN (EW10J4)	02.00 ->	4	100	CSS1522	---
607 2.0 HDI	4HX (DW12TED4, FAP)	02.00 ->	4	98	CSS1522	---
607 2.0 HDI	RHR (DW10BTED4)	09.05 ->	4	100	CSS1539	CSS1510
607 2.0 HDI	RHZ (DW10ATED)	05.00 ->	4	80	---	CSS1510
607 2.2 16V	3FY (EW12J4)	09.05 ->	4	120	CSS1522	---
607 2.2 16V	3FZ (EW12J4)	02.00 ->	4	116	CSS1513	CSS1511
607 2.2 16V	3FZ (EW12J4)	02.00 ->	4	116	CSS1522	---
607 2.2 16V	3FY (EW12J4)	09.05 ->	4	120	---	CSS1511
607 2.2 HDI	4HX (DW12TED4, FAP)	02.00 ->	4	98	CSS1513	---
607 2.2 HDI	4HT (DW12BTED4)	05.06 ->	4	125	CSS1517	CSS1510
607 2.2 HDI	4HX (DW12TED4 / FAP)	02.00 ->	4	98	CSS1513	CSS1510
607 3.0 V6 24V	XFV (ES9A)	03.04 ->	6	155	---	CSS1512
607 3.0 V6 24V	XFV (ES9A)	03.04 ->	6	155	CSS1522	---
607 3.0 V6 24V	AFX (ES9J4S)	02.00 ->	6	152	CSS1522	---
607 30. V6 24V	AFX (ES9J4S)	02.00 ->	6	152	CSS1514	---
806 1.8	LFW (XU7JP)	07.95 - 08.02	4	73	CSS1500	---
806 1.9 TD	DHX (XUD9TE)	07.95 - 08.02	4	66	CSS1506	---
806 1.9 TD	DHY (XUD9TE)	05.97 - 08.02	4	68	CSS1506	---
806 2.0	RFU (XU10J2)	06.94 - 08.02	4	89	CSS1506	---
806 2.0	RFU (XU10J2TE)	06.94 - 08.02	4	89	CSS1501	---
806 2.0 16V	RFN (EW10J4)	09.00 - 08.02	4	100	CSS1513	CSS1511
806 2.0 16V	RFV (XU10J4R)	05.98 - 09.00	4	97	CSS1506	CSS1509
806 2.0 HDI	RHZ (DW10ATED)	08.99 - 08.02	4	80	CSS1516	CSS1510
806 2.0 HDI 16V	RHW (DW10ATED4)	08.99 - 08.02	4	80	---	CSS1510
806 2.0 Turbo	RGX (XU10J2TE)	06.94 - 08.02	4	108	CSS1506	---
806 2.1 TD 12V	P8C (XUD11BTE)	06.96 - 08.99	4	80	CSS1506	---
807 2.0	RFJ (EW10A)	09.05 ->	4	103	CSS1522	---
807 2.0	RFN (EW10J4)	06.02 ->	4	100	CSS1522	CSS1511
807 2.0 16V	RFJ (EW10A)	09.05 ->	4	103	---	CSS1511

Typ Type	Motornummer Engine-No.	Baujahr Year	Zyl. Cyl.	KW	Kurbelwellen- sensor Crankshaft S.	Nocken- wellensensor Camshaft S.
807 2.0 HDI	RHH (DW10CTED4)	06.09 ->	4	120	---	CSS1510
807 2.0 HDI	RHK (DW10UTED4)	11.06 ->	4	88	---	CSS1510
807 2.0 HDI	RHR (DW10BTED4)	06.06 ->	4	100	---	CSS1510
807 2.0 HDi	RHR (DW10BTED4)	06.06 ->	4	100	CSS1539	---
807 2.0 HDI	RHS (DW10ATED4)	06.02 ->	4	79	---	CSS1510
807 2.2	3FZ (EW12J4)	06.02 ->	4	116	---	CSS1511
807 2.2 HDI	4HT (DW12BTED4)	06.06 ->	4	125	CSS1517	CSS1510
807 2.2 HDI	4HX (DW12TED4 / FAP)	06.02 ->	4	94	---	CSS1510
807 3.0 V6	XFJ (ES9J4S)	06.02 ->	6	150	CSS1522	CSS1512
1007 1.4	KFV (TU3JP)	04.05 ->	4	55	CSS1518	---
1007 1.4 16V	KFU (ET3J4)	10.05 ->	4	65	CSS1518	---
1007 1.4 HDI	8HX (DV4TD), 8HZ (DV4TD)	04.05 ->	4	50	CSS1517	CSS1519
1007 1.6 16V	NFU (TU5JP4)	04.05 ->	4	80	CSS1518	---
1007 1.6 HDI	9HZ (DV6TED4)	06.07 ->	4	80	CSS1517	CSS1510
2008 1.2 VTi	HMZ (EB2F)	03.13 ->	3	60	CSS1548	---
2008 1.2 THP 110	HNZ (EB2DT)	01.15 ->	3	81	CSS1548	---
2008 1.2 THP 130	HNY (EB2DTS)	01.15 ->	3	96	CSS1548	---
2008 1.6 BlueHDi 75	BHW (DV6FE)	01.15 ->	4	55	CSS1547	---
2008 1.6 HDi	9HD (DV6CTED)	03.13 ->	4	84	CSS1547	---
2008 1.6 HDi	9HP (DV6DTEd)	03.13 ->	4	68	CSS1547	---
2008 1.6 HDi	BHX (DV6FC)	07.14 ->	4	85	CSS1547	---
2008 1.6 VTi	5FS (EP6C)	03.13 ->	4	88	CSS1545	CSS920
3008 1.2	HNY (EB2DTS)	01.15 ->	3	96	CSS1548	---
3008 1.6 BlueHDi 120	BHZ (DV6FC)	05.14 ->	4	88	CSS1547	---
3008 1.6 HDi	9HD (DV6CTED)	03.13 ->	4	84	CSS1547	---
3008 1.6 HDi	9HR (DV6C)	08.10 ->	4	82	CSS1547	---
3008 1.6 HDI	9HR (DV6C)	08.10 ->	4	82	CSS1538	---
3008 1.6 HDI	9HZ (DV6TED4)	06.09 ->	4	80	CSS1538	CSS1510
3008 1.6 THP	5FV (EP6CDT)	06.09 ->	4	115	CSS1545	CSS920
3008 1.6 THP	5FX (EP6DT)	06.09 ->	4	110	CSS1545	CSS920
3008 1.6 Turbo	5GZ (EP6FDT)	05.14 ->	4	121	CSS1545	CSS920
3008 1.6 VTi	5FS (EP6C), EP6	06.09 ->	4	88	CSS912	---
3008 1.6 VTi	5FS (EP6C), EP6, 5FW (EP6)	06.09 ->	4	88	---	CSS920
3008 2.0 HDi	---	09.11 ->	4	100	CSS1539	CSS1510
3008 2.0 HDi	---	02.12 ->	4	100	CSS1539	---
3008 2.0 HDi	RHE (DW10CTED4)	06.09 ->	4	110	CSS1539	---
3008 2.0 HDI	RHH (DW10CTED4)	06.09 ->	4	120	---	CSS1510
3008 2.0 HDI	RHE (DW10CTED4)	06.09 ->	4	110	---	CSS1510
3008 2.0 HDi Hybrid4	---	11.11 ->	4	147	---	CSS1510
3008 2.0 Hybrid4	RHH (DW10CTED4)	02.11 ->	4	120	---	CSS1510
3008 SUV 1.2	HNY (EB2DTS)	05.16 ->	3	96	CSS1548	---
4007 2.2 HDI	4HN (DW12MTED4)	02.07 ->	4	115	CSS1517	CSS1510
4008 1.6 HDi AWC	9HD (DV6C)	05.12 ->	4	84	CSS1547	---
5008 1.2	HNY (EB2DTS)	01.15 ->	3	96	CSS1548	---
5008 1.6	5GZ (EP6FDT)	02.12 ->	4	120	---	CSS920
5008 1.6 16V	5FS (EP6C), 5FW (EP6), EP6	09.09 ->	4	88	CSS1545	---
5008 1.6 16V	5FS (EP6C), EP6	09.09 ->	4	88	CSS912	---
5008 1.6 16V	5FS (EP6C), EP6, 5FW (EP6)	09.09 ->	4	88	---	CSS920
5008 1.6 16V	5FV (EP6CDT)	09.09 ->	4	115	CSS1545	---
5008 1.6 16V	EP6CDT	09.09 ->	4	115	CSS912	CSS920
5008 1.6 BlueHDi 120	BHZ (DV6FC)	05.14 ->	4	88	CSS1547	---
5008 1.6 HDi	9HD (DV6CTED)	03.13 ->	4	84	CSS1547	---
5008 1.6 HDi	9HR (DV6C)	08.10 ->	4	82	CSS1547	---
5008 1.6 HDI	9HZ (DV6TED4)	09.09 ->	4	80	CSS1538	CSS1510
5008 1.6 THP 150	---	02.12 ->	4	110	---	CSS920
5008 1.6 THP 163	5GZ (EP6FDT)	02.12 ->	4	120	CSS1545	---
5008 1.6 THP 165	5GZ (EP6FDT)	02.12 ->	4	121	CSS1545	CSS920
5008 2.0 HDi	---	02.12 ->	4	100	---	CSS1510
5008 2.0 HDI	RHE (DW10CTED4)	09.09 ->	4	120	---	CSS1510

Typ Type	Motornummer Engine-No.	Baujahr Year	Zyl. Cyl.	KW	Kurbelwellen- sensor Crankshaft S.	Nocken- wellensensor Camshaft S.
5008 2.0 HDI	RHH (DW10CTED4)	06.09 ->	4	110	---	CSS1510
5008 2.0 HDi 136/BlueHDI 136	AHV (DW10FD)	02.12 ->	4	100	CSS1546	---
Bipper 1.3 HDi 75	199 A9.000	10.10 ->	4	55	---	CSS716
Bipper 1.4	KFV (TU3A)	02.08 ->	4	54	CSS1518	---
Bipper 1.4 HDi	8HS (DV4TD)	02.08 ->	4	50	CSS1538	CSS1519
Bipper Tepee 1.3 HDi 75	199 A9.000	10.10 ->	4	55	---	CSS716
Bipper Tepee 1.4 HDi	8HS (DV4TD)	04.08 ->	4	50	---	CSS1519
Boxer 1.9 D	D8C (XUD9AU)	03.94 - 04.02	4	51	CSS1504	---
Boxer 1.9 TD	D8C (XUD9UTF)	03.94 - 04.02	4	68	CSS1504	---
Boxer 1.9 TD	DHY (XUD9TE)	08.94 - 04.02	4	66	CSS1504	---
Boxer 2.0	RFL (XU10J2U)	04.02 ->	4	81	CSS1513	CSS1511
Boxer 2.0 BlueHDI 130	AHN (DW10FUD)	07.15 ->	4	96	CSS1546	---
Boxer 2.0 BlueHDI 160	AHP (DW10FUC)	07.15 ->	4	120	CSS1546	---
Boxer 2.0 HDI	RHV (DW10UTD)	04.02 ->	4	62	CSS1513	---
Boxer 2.0 HDi	4HY (DW12UTED)	04.02 ->	4	74	CSS1513	---
Boxer 2.0i	RFW (XU10J2)	06.94 - 04.02	4	80	CSS1513	---
Boxer 2.2 HDI	4HY (DW12UTED)	04.02 ->	4	74	CSS1513	---
Boxer 2.5 D	T9A (DJ5)	08.94 - 04.02	4	63	CSS1504	---
Boxer 2.5 TD	T8A (DJ5T)	07.94 - 04.02	4	76	CSS1504	---
Boxer 2.5 TDI	THX (DJ5TED)	01.97 - 04.02	4	79	CSS1504	---
Expert 1.6 HDi 90	RHW (DW10ATED4)	01.07 ->	4	66	---	CSS1510
Expert 1.9 D	D9B (XUD9AU)	02.96 ->	4	51	CSS1504	---
Expert 1.9 D	D9B (XUD9AU)	02.96 ->	4	51	CSS1504	---
Expert 1.9 D 70	WJY (DW8B), WYZ (DW8)	12.98 ->	4	51	CSS1505	---
Expert 1.9 TD	D8B (XUD9TE)	02.96 ->	4	68	CSS1504	---
Expert 1.9 TD	D8B (XUD9TE)	02.96 ->	4	68	CSS1504	---
Expert 1.9 TD	DHX (XUD9TE)	02.96 ->	4	66	CSS1504	---
Expert 1.9 TD	DHX (XUD9TE)	02.96 ->	4	66	CSS1504	---
Expert 2.0	RFN (EW10J4)	07.00 ->	4	100	CSS1513	CSS1511
Expert 2.0	RFN (EW10J4)	09.02 ->	4	100	---	CSS1511
Expert 2.0 HDI	RHW (DW10ATED4)	07.00 ->	4	80	---	CSS1510
Expert 2.0 HDI	RHW (DW10ATED4)	07.00 ->	4	80	---	CSS1510
Expert 2.0 HDI	RHX (DW10BTED)	07.00 ->	4	69	CSS1516	CSS1510
Expert 2.0 HDI	RHZ (DW10ATED)	07.00 ->	4	80	CSS1516	CSS1510
Expert 2.0 HDI	RHZ (DW10ATED)	07.00 ->	4	80	CSS1516	CSS1510
Expert 2.0 HDI 120	RHK (DW10UTED4)	01.07 ->	4	88	CSS1517	CSS1510
Expert 2.0 HDi 120	RHK (DW10UTED4)	01.07 ->	4	88	CSS1539	---
Expert 2.0 HDI 140	RHR (DW10BTED4)	01.07 ->	4	100	---	CSS1510
Expert 2.0 HDI 165	RHH (DW10CTED4)	09.09 ->	4	120	---	CSS1510
Expert Box 1.6 HDi 90 8V	9HH (DV6DUM), 9HM (DV6UC)	01.07 ->	4	66	CSS1547	---
Expert Tepee 1.6 HDi 90 8V	9HH (DV6DUM), 9HM (DV6UC)	01.07 ->	4	66	CSS1547	---
Expert Tepee 2.0 16V	RFJ (EW10A), RFH (EW10A)	01.07 ->	4	103	CSS1522	---
Expert Tepee 2.0 HDi 120	RHK (DW10UTED4)	01.07 ->	4	88	CSS1539	---
Partner 1.1	HDZ (TU1M)	06.96 ->	4	44	CSS1502	---
Partner 1.4	KFX (TU3JP)	06.96 ->	4	55	CSS1518	CSS1503
Partner 1.6	5FK (EP6CB)	11.10 ->	4	72	CSS1545	---
Partner 1.6	5FS (EP6C)	04.10 ->	4	88	CSS1545	---
Partner 1.6 BlueHDI 100	BHY (DV6FD)	04.15 ->	4	73	CSS1547	---
Partner 1.6 BlueHDI 120	BHZ (DV6FC)	04.15 ->	4	88	CSS1547	---
Partner 1.6 HDi	9HF (DV6DTED)	03.13 ->	4	66	CSS1547	---
Partner 1.6 HDi	9HL (DV6C)	03.13 ->	4	84	CSS1547	---
Partner 1.6 HDI	9HT (DV6BTED4)	04.08 ->	4	55	---	CSS1510
Partner 1.6 HDI	9HX (DV6ATED4)	04.08 ->	4	66	---	CSS1510
Partner 1.6 HDI	9HZ (DV6TED4)	04.08 ->	4	80	---	CSS1510
Partner 1.6 HDI 75	9HW (DV6BTED4)	02.06 ->	4	55	CSS1517	CSS1510
Partner 1.6 HDi 90	9HP (DV6DTED)	04.10 ->	4	68	CSS1547	---
Partner 1.6 HDI 90	9HX (DV6ATED4)	02.06 ->	4	66	CSS1517	CSS1510
Partner 1.6 HDi/BlueHDI 75	9HN (DV6ETED), BHW (DV6FE)	01.14 ->	4	55	CSS1547	---
Partner 1.9 D	WJY (DW8B), WJZ (DW8)	06.96 ->	4	51	CSS1501	---

Typ Type	Motornummer Engine-No.	Baujahr Year	Zyl. Cyl.	KW	Kurbelwellen- sensor Crankshaft S.	Nocken- wellensensor Camshaft S.
Partner 2.0 HDI	RHY (DW10TD)	04.00 ->	4	66	---	CSS1510
Partner 2.0 HDI	RHY (DW10TD)	04.00 ->	4	66	CSS1514	CSS1510
Partner Combispac 1.1	HDZ (TU1M)	06.96 ->	4	44	CSS1502	---
Partner Combispac 1.4	KFW (TU3JP), KFX (TU3JP)	06.96 ->	4	55	CSS1502	CSS1503
Partner Combispac 1.6 16V	NFU (TU5JP4)	07.01 ->	4	80	CSS1515	---
Partner Combispac 1.6 HDI 75	9HW (DV6BTED4)	02.06 ->	4	55	CSS1517	CSS1510
Partner Combispac 1.6 HDI 90	9HX (DV6ATED4)	02.06 ->	4	66	CSS1517	CSS1510
Partner Combispac 1.8	LFX (XU7JB)	05.97 ->	4	66	CSS1501	---
Partner Combispac 1.9 D	DJY (XUD9A)	06.96 ->	4	50	CSS1504	---
Partner Combispac 1.9 D	WJY (DW8B), WYZ (DW8)	12.98 ->	4	51	CSS1514	---
Partner Combispac 2.0 HDI	RHY (DW10TD)	02.00 ->	4	66	CSS1514	CSS1510
Partner Combispac 2.0 HDI	RHY (DW10TD)	02.00 - 08.02	4	66	CSS1513	---
Partner Combispac 2.0 HDI	RHY (DW10TD)	02.00 ->	4	66	CSS1522	---
Partner Tepee 1.2 THP	HNV (EB2DTM), HNZ (EB2DT)	02.16 ->	3	81	CSS1548	---
Partner Tepee 1.6	5FK (EP6CB)	08.10 ->	4	72	CSS1545	---
Partner Tepee 1.6	5FK (EP6CB)	08.10 ->	4	72	---	CSS920
Partner Tepee 1.6	5FS (EP6C)	04.10 ->	4	88	CSS912	CSS920
Partner Tepee 1.6	5FS (EP6C)	04.10 ->	4	88	CSS1545	---
Partner Tepee 1.6 BlueHDi 100	BHY (DV6FD)	12.14 ->	4	73	CSS1547	---
Partner Tepee 1.6 BlueHDi 120	BHZ (DV6FC)	12.14 ->	4	88	CSS1547	---
Partner Tepee 1.6 BlueHDi 75	BHW (DV6FE)	01.15 ->	4	55	CSS1547	---
Partner Tepee 1.6 HDi	9HL (DV6C)	03.13 ->	4	84	CSS1547	---
Partner Tepee 1.6 HDi	9HL (DV6C)	08.10 ->	4	82	CSS1547	---
Partner Tepee 1.6 HDi 90	9HP (DV6DTE)	04.10 ->	4	68	CSS1547	---
RCZ 1.6 16V	5FV (EP6CDT)	03.10 ->	4	115	CSS1545	---
RCZ 1.6 16V	EP6CDT	03.10 ->	4	115	CSS912	CSS920
RCZ 1.6 16V	EP6CDTX	06.10 ->	4	147	CSS912	CSS920
RCZ 1.6 THP 270	5FG (EP6CDTR)	06.13 ->	4	199	---	CSS920
RCZ 2.0 HDI	RHH (DW10CTED4)	03.10 ->	4	120	---	CSS1510

## Porsche

911 (996) 3.4 Carrera	M 96.01, M 96.04	09.97 - 09.01	6	221	---	CSS200
911 (996) 3.4 Carrera 4	M 96.01, M 96.04	09.97 - 09.01	6	221	---	CSS200
911 (996) 3.4 Carrera 4 Cabriolet	M 96.02, M 96.04	02.98 - 09.01	6	221	---	CSS200
911 (996) 3.4 Carrera Cabriolet	M 96.01 (02.98-), M 96.04	02.98 - 09.01	6	221	---	CSS200
911 (996) 3.6 Carrera	M 96.03	10.01 - 08.05	6	235	---	CSS914
911 (996) 3.6 Carrera	M 96.03	10.01 - 08.05	6	235	---	CSS200
911 (996) 3.6 Carrera 4	M 96.03	10.01 - 08.05	6	235	---	CSS200
911 (996) 3.6 Carrera 4	M 96.03	10.01 - 08.05	6	235	---	CSS914
911 (996) 3.6 Carrera 4 Cabriolet	M 96.03	10.01 - 08.05	6	235	---	CSS914
911 (996) 3.6 Carrera 4 Cabriolet	M 96.03	10.01 - 08.05	6	235	---	CSS200
911 (996) 3.6 Carrera 4S	M 96.03	02.03 - 08.05	6	254	---	CSS200
911 (996) 3.6 Carrera 4S Cabriolet	M 96.03	06.02 - 08.05	6	254	---	CSS200
911 (996) 3.6 Carrera Cabriolet	M 96.03	10.01 - 08.05	6	235	---	CSS914
911 (996) 3.6 Carrera Cabriolet	M 96.03	10.01 - 08.05	6	235	---	CSS200
911 (996) 3.6 Carrera S	M 96.03	02.03 - 08.05	6	254	---	CSS200
911 (996) 3.6 GT2	M 96.70	04.01 - 08.05	6	340	---	CSS200
911 (996) 3.6 Targa	M 96.03	12.01 - 08.05	6	235	---	CSS200
911 (996) 3.6 Turbo 4	M 96.70	06.00 - 08.05	6	309	---	CSS200
911 (996) 3.6 Turbo 4 Cabriolet	M 96.70	10.03 - 08.05	6	309	---	CSS200
911 9 Targa 3.6	M 96.03	12.01 - 08.05	6	235	---	CSS914
Boxster (986) 2.5	M 96.20	09.96 - 08.99	6	150	---	CSS402
Boxster (986) 2.5	M 96.20 (09.96-)	09.96 - 08.99	6	150	---	CSS200
Boxster (986) 2.7	---	06.99 - 12.02	6	155	---	CSS200
Boxster (986) 2.7	M 96.22	08.99 - 07.02	6	162	---	CSS200
Boxster (986) S 3,2	M 96.24	07.02 - 12.04	6	191	---	CSS914
Boxster (986) S 3.2	M 96.21	08.99 - 07.02	6	185	---	CSS200
Boxster (986) S 3.2	M 96.24	01.04 - 12.04	6	196	---	CSS914
Carrera GT 5.7	M 80.01	07.03 - 12.06	10	450	---	CSS914

Typ Type	Motornummer Engine-No.	Baujahr Year	Zyl. Cyl.	KW	Kurbelwellen- sensor Crankshaft S.	Nocken- wellensensor Camshaft S.
Cayenne (9PA) 3.2	M 02.2Y	10.03 - 09.07	6	184	---	CSS323
Cayenne (9PA) S 4.5	M 48.00	09.02 - 09.07	8	250	---	CSS200
Cayenne (9PA) Turbo 4.5	M 48.50	09.02 - 09.07	8	331	---	CSS200
Cayenne (9PA) Turbo S 4.5	M 48.50S	01.04 - 09.07	8	368	---	CSS200
Cayenne (9PA) Turbo S 4.5	M 48.50T	03.06 - 09.07	8	383	---	CSS200
<b>Renault</b>						
11 1.4	C2J 720, -766, -767, -768	03.83 - 12.88	4	49	CSS1524	---
11 1.7	F2N 700, -704	10.83 - 12.87	4	59	CSS1524	---
18 1.4	847 720, 847 722	04.78 - 07.86	4	47	CSS1524	---
18 1.6 TS	A6M 725, A6M 726	05.82 - 07.86	4	71	CSS1524	---
18 2.0	J6R 716	05.82 - 07.86	4	77	CSS1524	---
19 I 1.7	F3N 742, -743	09.88 - 04.92	4	66	CSS1527	---
19 I 1.7	F3N 749, -741	09.88 - 04.92	4	54	CSS1527	---
19 I 1.8 16V	F7P 704	06.89 - 04.92	4	99	CSS1527	---
19 I Cabriolet 1.7	F3N 742, -743	07.91 - 04.92	4	70	CSS1527	---
19 I Cabriolet 1.8 16V	F7P 704	07.91 - 04.92	4	101	CSS1527	---
19 I Chamade 1.7	F3N 740, -F3N 741	10.89 - 04.92	4	54	CSS1527	---
19 I Chamade 1.7	F3N 742, -743	07.88 - 04.92	4	66	CSS1527	---
19 I Chamade 1.8 16V	F7P 704	10.89 - 04.92	4	99	CSS1527	---
19 II 1.4	C3J 710	04.92 - 12.95	4	43	CSS1526	---
19 II 1.4	E7J 742	01.92 - 12.95	4	55	CSS1526	---
19 II 1.7	F3N 740, -F3N 741	04.92 - 12.95	4	54	CSS1527	---
19 II 1.8 16V	F7P 704	04.92 - 12.95	4	99	CSS1527	---
19 II Cabriolet 1.7	F3N 742, -743	04.92 - 09.93	4	66	CSS1526	---
19 II Cabriolet 1.8 16V	F7P 704	04.92 - 06.96	4	99	CSS1527	---
19 II Chamade 1.4	C3J 710	04.92 - 12.95	4	43	CSS1526	---
19 II Chamade 1.4	E7J 742	11.93 - 12.95	4	55	CSS1526	---
19 II Chamade 1.7	F3N 740, -F3N 741	04.92 - 12.95	4	54	CSS1526	---
19 II Chamade 1.8 16V	F7P 704	04.92 - 12.95	4	99	CSS1527	---
21 1.7	F2N 750, F3N 726	07.86 - 02.94	4	54	CSS1526	---
21 1.7	F3N 722, -723	09.89 - 06.94	4	66	CSS1526	---
21 1.7	F3N 726	09.89 - 10.92	4	54	CSS1526	---
21 2.0	J7R 740	02.90 - 10.92	4	99	CSS1526	---
21 2.0 Turbo	J7R 752	04.87 - 03.90	4	129	CSS1527	---
21 2.0 Turbo	J7R 756	02.90 - 10.92	4	119	CSS1527	---
21 2.2	J7T 754, -755	09.89 - 06.94	4	79	CSS1527	---
21 2.2	J7T 754, -755	06.86 - 11.93	4	79	CSS1527	---
21 2.2	J7T 754, -755	07.86 - 02.94	4	79	CSS1527	---
21 2.2 4x4	J7T 754, -755	07.90 - 06.94	4	79	CSS1527	---
25 2.0	J6R 706, -707, -760, -762, -763	04.84 - 12.92	4	74	CSS1524	---
25 2.0 12V	J7R 720, J7R 721	06.88 - 12.93	4	103	CSS1527	---
25 2.0 12V	J7R 726	06.89 - 12.92	4	99	CSS1527	---
25 2.2	---	11.85 - 03.89	4	76	CSS1527	---
25 2.2	J7T 706, -707, -714, -715	04.84 - 12.89	4	89	CSS1527	---
25 2.2	J7T 708, -732, -733	09.86 - 12.92	4	79	CSS1527	---
25 2.2	J7T 730, -731	04.84 - 12.89	4	91	CSS1527	---
25 2.5 V6 Turbo	Z7U 700	01.90 - 12.92	6	151	CSS1527	---
25 2.8 V6	Z7W 700	06.87 - 02.90	6	115	CSS1527	---
25 2.8 V6 Injection	Z7W 706, -707, -709	06.87 - 12.92	6	110	CSS1527	---
Avantime 2.2 dCi	G9T 712	05.02 - 05.03	4	110	---	CSS1530
Avantime 3.0 V6	L7X 720, -721	09.01 - 05.03	6	152	CSS1531	---
Captur 0.9 TCe 90	H4B 400	06.13 ->	3	66	CSS1544	---
Captur 1.2 TCe 120	H5F 403	06.13 ->	4	88	CSS1544	---
Captur 1.5 dCi 110	K9K 646	01.15 ->	4	81	CSS1537	---
Captur 1.5 dCi 90	K9K 608, K9K 609	06.13 ->	4	66	CSS1537	---
Clio Grandtour 1.2 16V	D4F 764	02.08 ->	4	58	---	CSS1540
Clio Grandtour 1.2 16V	D4F 786	09.10 ->	4	76	CSS1532	---
Clio Grandtour 1.5 dCi	K9K 764, K9K 774	02.08 ->	4	78	CSS1541	CSS1540

Typ Type	Motornummer Engine-No.	Baujahr Year	Zyl. Cyl.	KW	Kurbelwellen- sensor Crankshaft S.	Nocken- wellensensor Camshaft S.
Clio Grandtour 1.5 dCi	K9K 766	02.08 ->	4	63	CSS1541	CSS1540
Clio Grandtour 1.5 dCi	K9K 768, K9K 714	02.08 ->	4	50	CSS1541	CSS1540
Clio Grandtour 1.5 dCi	K9K 770, K9K 772	08.10 ->	4	65	CSS1537	---
Clio Grandtour 1.5 dCi	K9K 770, K9K 772	08.10 ->	4	65	CSS1541	---
Clio Grandtour 1.5 dCi	K9K 772	02.08 ->	4	76	CSS1541	---
Clio Grandtour 1.6 16V	K4M 800, K4M 801	02.08 ->	4	82	---	CSS1540
Clio Grandtour 1.6 16V	K4M 862	11.08 ->	4	94	---	CSS1540
Clio Grandtour IV 1.2 16V	D4F 740	01.13 ->	4	54	CSS1532	---
Clio Grandtour IV 1.5 dCi 75	K9K 612	01.13 ->	4	55	CSS1537	---
Clio Grandtour IV 1.5 dCi 90	K9K 608	01.13 ->	4	66	CSS1537	---
Clio I 1.2	C3G 720	01.96 - 12.96	4	40	CSS1526	---
Clio I 1.2	D7F 730	01.96 - 09.98	4	40	CSS1529	---
Clio I 1.2	D7F 730	01.96 - 09.98	4	43	CSS1529	---
Clio I 1.2	D7F 730	01.96 - 09.98	4	43	CSS1532	---
Clio I 1.2	D7F 730	01.96 - 09.98	4	40	CSS1532	---
Clio I 1.2	E7F 700, -708, -750	05.90 - 09.98	4	43	CSS1529	---
Clio I 1.2	E7F 700, -708, -750	05.90 - 09.98	4	43	CSS1532	---
Clio I 1.2	E7F 706	01.91 - 01.96	4	40	CSS1529	---
Clio I 1.4	E7J 718, -719, -754	01.91 - 09.98	4	58	CSS1532	---
Clio I 1.4	E7J 756, E7J 757	01.91 - 09.98	4	55	CSS1532	---
Clio II 1.2	D7F 710, -720, -726	09.98 ->	4	43	CSS1532	---
Clio II 1.2 416V	K4J 712, K4J 713	10.99 - 08.00	4	70	CSS1532	---
Clio II 1.4 16V	K4J 700, -712, -713	08.00 ->	4	72	CSS1535	---
Clio II 1.4 16V	K4J 712, K4J 713	10.99 - 08.00	4	70	CSS1535	---
Clio II 1.5 dCi	K9K 700, K9K 704	06.01 ->	4	48	CSS1532	---
Clio II 1.5 dCi	K9K 702	06.01 -10.03	4	60	CSS1532	CSS1540
Clio II 1.5 dCi	K9K 702	06.01 ->	4	60	---	CSS1540
Clio II 1.5 dCi	K9K 704	06.01 - 12.06	4	42	---	CSS1540
Clio II 1.5 dCi	K9K 704, K9K 700	06.01 ->	4	48	---	CSS1540
Clio II 1.5 dCi	K9K 712	01.04 ->	4	74	CSS1541	---
Clio II 1.5 dCi	K9K 714, K9K 700	08.04 ->	4	50	CSS1541	---
Clio II 1.5 dCi	K9K 718	02.07 ->	4	62	CSS1541	CSS1540
Clio II 1.5 dCi	K9K 740	06.05 ->	4	47	CSS1541	CSS1540
Clio II 1.6	K7M 744, K7M 745	09.98 - 05.05	4	66	CSS1532	---
Clio II 1.6	K7M 744, K7M 745	09.98 - 05.05	4	66	CSS1533	---
Clio II 1.6 16V	K4M 708, K4M 748	09.98 ->	4	79	CSS1532	---
Clio II 1.9 D	F8Q 630	09.98 - 05.05	4	47	CSS1532	---
Clio II 1.9 dTi	F9Q 780	02.00 - 05.05	4	59	CSS1532	---
Clio II 2.0 16V Sport	F4R 730	02.00 ->	4	124	CSS1532	---
Clio II 3.0 V6 Sport	L7X 760	11.00 - 12.02	6	166	CSS1532	---
Clio II 3.0 V6 Sport	L7X 762	12.02->	6	187	CSS1532	---
Clio II 3.0 V6 Sport	L7X 760	11.00 - 12.02	6	166	CSS1531	---
Clio II 3.0 V6 Sport	L7X 762	12.02 - 06.05	6	187	CSS1531	---
Clio III 1.2 16V	D4F 740	06.05 ->	4	55	CSS1532	---
Clio III 1.2 16V	D4F 740	06.05 ->	4	48	CSS1532	---
Clio III 1.2 16V	D4F 740	06.05 ->	4	55	CSS1532	---
Clio III 1.2 16V	D4F 764	06.05 ->	4	48	CSS1532	---
Clio III 1.2 16V	D4F 764	06.05 ->	4	58	CSS1532	CSS1540
Clio III 1.2 16V	D4F 764	06.05 ->	4	57	CSS1532	---
Clio III 1.2 16V	D4F 784	05.07 ->	4	74	CSS1532	---
Clio III 1.2 16V	D4F 786	09.10 ->	4	76	CSS1532	---
Clio III 1.2 16V Hi-Flex	D4F 740, D4F 742	07.08 ->	4	55	CSS1532	---
Clio III 1.5 dCi	K9K 752	06.05 ->	4	47	---	CSS1540
Clio III 1.5 dCi	K9K 752	05.05 ->	4	48	---	CSS1540
Clio III 1.5 dCi	K9K 764	06.05 ->	4	78	CSS1537	---
Clio III 1.5 dCi	K9K 764, K9K 774	06.05 ->	4	78	CSS1541	CSS1540
Clio III 1.5 dCi	K9K 766	06.05 ->	4	63	CSS1541	CSS1540
Clio III 1.5 dCi	K9K 768, K9K 714	06.05 ->	4	50	CSS1541	CSS1540
Clio III 1.5 dCi	K9K 772	06.05 ->	4	76	CSS1537	---

Typ Type	Motornummer Engine-No.	Baujahr Year	Zyl. Cyl.	KW	Kurbelwellen- sensor Crankshaft S.	Nocken- wellensensor Camshaft S.
Clio III 1.5 dCi	K9K 772	06.05 ->	4	76	CSS1541	CSS1540
Clio III 1.6 16V	K4M 800, K4M 801	06.05 ->	4	82	---	CSS1540
Clio III 1.6 16V	K4M 804	06.05 ->	4	65	---	CSS1540
Clio III 1.6 16V GT	K4M 862	06.09 ->	4	94	---	CSS1540
Clio III 2.0 16V Sport	F4R 830	09.08 ->	4	148	---	CSS1540
Clio III 2.0 16V Sport	F4R 830	02.06 ->	4	145	---	CSS1540
Clio III Grandtour 1.2 16V	D4F 740	02.08 ->	4	55	CSS1532	---
Clio III Grandtour 1.2 16V	D4F 764	02.08 ->	4	58	CSS1532	---
Clio III Grandtour 1.2 16V	D4F 784	02.08 ->	4	74	CSS1532	---
Clio III Grandtour 1.2 16V	D4F 786	09.10 ->	4	76	CSS1532	---
Clio III Grandtour 1.2 16V Hi-Flex	D4F 740	07.08 ->	4	55	CSS1532	---
Clio IV 0.9 TCe 90	H4B 400	11.12 ->	3	66	CSS1544	---
Clio IV 1.2 16V	D4F 740	11.12 ->	4	54	CSS1532	---
Clio IV 1.2 TCe 120	H5F 403	03.13 ->	4	88	CSS1544	---
Clio IV 1.2 TCe 120	H5F 412	01.16 ->	4	87	CSS1544	---
Clio IV 1.5 dCi 75	K9K 612	11.12 ->	4	55	CSS1537	---
Clio IV Grandtour 0.9 TCe 90	H4B 400	01.13 ->	3	66	CSS1544	---
Clio IV Grandtour 1.2 TCe 120	H5F 403	03.13 ->	4	88	CSS1544	---
Clio IV Grandtour 1.2 TCe 120	H5F 412	01.16 ->	4	87	CSS1544	---
Espace I 2.0	J6R 234, -236	07.84 - 12.90	4	80	CSS1523	---
Espace I 2.0i Quadra	J7R 760	03.88 - 12.92	4	87	CSS1527	---
Espace I 2.2	J7T 770	07.86 - 12.90	4	79	CSS1529	---
Espace II 2.0	J7R 768	01.91 - 10.96	4	76	CSS1527	---
Espace II 2.2	J7T 772, -773, -776	01.91 - 10.96	4	79	CSS1529	---
Espace II 2.2 4x4	J7T 773, -772	03.91 - 12.96	4	79	CSS1527	---
Espace II 2.8 V6	Z7W 712, -713, -717	01.91 - 10.96	6	110	CSS1527	---
Espace III 2.0	F4R 700, F4R 701	09.01 ->	4	102	CSS1534	---
Espace III 2.0 16V	K4R 700, K4R 701	10.98 - 10.02	4	103	CSS1535	---
Espace III 3.0 V6 24V	L7X 727	10.98 - 10.02	6	140	CSS1500	---
Espace IV 1.9 dCi	F9Q 680, -820, -826	11.02 ->	4	88	---	CSS1530
Espace IV 2.0 dCi	M9R 740, M9R 750, M9R 815	01.06 ->	4	110	---	CSS1540
Espace IV 2.0 dCi	M9R 761, M9R 762, M9R 740	01.06 ->	4	96	---	CSS1540
Espace IV 2.2 dCi	G9T 742, -743	11.02 ->	4	110	---	CSS1530
Fluence 1.5 dCi	K9K 826	07.14 ->	4	70	CSS1537	---
Fluence 1.5 dCi	K9K 830	02.10 ->	4	63	CSS1541	---
Fluence 1.5 dCi	K9K 832	02.10 ->	4	78	CSS1541	---
Fluence 1.5 dCi	K9K 834	02.10 ->	4	66	CSS1541	---
Fluence 1.5 dCi	K9K 836, K9K 837	02.10 ->	4	81	CSS1541	---
Fluence 1.5 dCi	K9K 830	02.10 ->	4	63	CSS1537	---
Fluence 1.5 dCi	K9K 834	02.10 ->	4	66	CSS1537	---
Fluence 1.5 dCi	K9K 836, K9K 837	02.10 ->	4	81	CSS1537	---
Fluence 1.6 16V	K4M 838	02.10 ->	4	82	CSS1542	---
Fluence 1.6 16V	K4M 838, K4M 839	02.10 ->	4	81	CSS1534	---
Fluence 1.6 16V	K4M 839, K4M 838	02.10 ->	4	81	CSS1542	---
Grand Scénic II 1.5 dCi	K9K 728	04.04 ->	4	74	CSS1541	---
Grand Scénic II 1.5 dCi	K9K 734	06.06 - 11.08	4	76	CSS1541	---
Grand Scénic III 1.5 dCi	K9K 830	04.09 ->	4	63	CSS1541	---
Grand Scénic III 1.5 dCi	K9K 832	02.09 ->	4	78	CSS1541	---
Grand Scénic III 1.5 dCi	K9K 836, K9K 837, K9K 636	04.09 ->	4	81	CSS1541	---
Grand Scénic II 1.5 dCi	K9K 728	04.04 ->	4	74	---	CSS1540
Grand Scénic II 1.5 dCi	K9K 734	06.06 - 11.08	4	76	---	CSS1540
Grand Scénic II 1.5 dCi	K9K P 732	05.05 ->	4	78	---	CSS1540
Grand Scénic II 1.6	K4M 761, K4M 782	04.04 ->	4	83	CSS1534	CSS1540
Grand Scénic II 2.0	F4R 771, F4R 770	04.04 ->	4	99	---	CSS1540
Grand Scénic II 2.0	F4R 776	04.04 ->	4	120	---	CSS1540
Grand Scénic II 2.0 dCi	M9R 721, M9R 722, M9R 700	09.05 ->	4	110	---	CSS1540
Grand Scénic III 1.2 TCe	H5F 400	04.12 ->	4	85	CSS1544	---
Grand Scénic III 1.2 TCe	H5F 404	01.13 ->	4	97	CSS1544	---
Grand Scénic III 1.4 16V	H4J 700	02.09 ->	4	96	CSS1544	---

Typ Type	Motornummer Engine-No.	Baujahr Year	Zyl. Cyl.	KW	Kurbelwellen- sensor Crankshaft S.	Nocken- wellensensor Camshaft S.
Grand Scénic III 1.5 dCi	K9K 846	11.10 ->	4	70	CSS1537	---
Grand Scénic III 1.6 dCi	R9M 402, R9M 404	04.11 ->	4	96	CSS1537	---
Grand Scénic III 1.9 dCi	F9Q 872, F9Q 870	02.09 ->	4	96	---	CSS1540
Grand Scénic III 2.0 dCi	M9R 610	04.09 ->	4	118	---	CSS1540
Grand Scénic III 2.0 dCi	M9R 615	02.09 ->	4	110	---	CSS1540
Kadjar 1.2 TCe 130	H5F 408	06.15 ->	4	96	CSS1544	---
Kangoo / Grand Kangoo 1.5 dCi	K9K 800	02.08 ->	4	50	CSS1541	---
Kangoo / Grand Kangoo 1.5 dCi	K9K 802	11.12 ->	4	55	CSS1537	---
Kangoo / Grand Kangoo 1.5 dCi	K9K 802	02.08 ->	4	63	CSS1541	CSS1540
Kangoo / Grand Kangoo 1.5 dCi	K9K 802, K9K 608	11.12 ->	4	55	CSS1541	---
Kangoo / Grand Kangoo 1.5 dCi	K9K 804	02.08 ->	4	78	---	CSS1540
Kangoo / Grand Kangoo 1.5 dCi	K9K 806, K9K 804	02.08 ->	4	76	CSS1541	CSS1540
Kangoo / Grand Kangoo 1.5 dCi	K9K 808	11.12 ->	4	66	CSS1537	---
Kangoo / Grand Kangoo 1.5 dCi	K9K 808	11.12 ->	4	66	CSS1541	---
Kangoo / Grand Kangoo 1.5 dCi	K9K 714, K9K 840, K9K 800	02.08 ->	4	50	---	CSS1540
Kangoo / Grand Kangoo 1.5 dCi 110	K9K 636	03.13 ->	4	81	CSS1541	---
Kangoo / Grand Kangoo 1.5 dCi 110	K9K 804	09.10 ->	4	80	CSS1537	---
Kangoo / Grand Kangoo 1.5 dCi 110	K9K 804	09.10 ->	4	80	CSS1541	CSS1540
Kangoo 1.2	D7F 710, -720, -722, -726	03.98 ->	4	43	CSS1532	---
Kangoo 1.2 16V	D4F 712, -714, -716	06.01 ->	4	55	CSS1532	---
Kangoo 1.4	E7J 634, -635, -780, -700, -701	03.98 ->	4	55	CSS1532	---
Kangoo 1.5 dCi	K9K 702, K9K 700	04.05 - 06.10	4	45	---	CSS1540
Kangoo 1.5 dCi	K9K 704	07.03 ->	4	42	---	CSS1540
Kangoo 1.5 dCi	K9K 704, K9K 700	12.01 ->	4	48	---	CSS1540
Kangoo 1.5 dCi	K9K 802	02.08 ->	4	63	CSS1537	---
Kangoo 1.5 dCi	K9K 804, K9K 806	02.08 ->	4	76	CSS1537	---
Kangoo 1.5 dCi	K9K 806	02.09 ->	4	76	CSS1537	---
Kangoo 1.5 dCi	K9K 840	02.08 ->	4	50	CSS1537	---
Kangoo 1.6	K7M 750	02.08 ->	4	64	CSS1532	---
Kangoo 1.6 16V	K4M 706, K4M 750, K4M 753	06.01 -	4	70	CSS1542	---
Kangoo 1.6 16V	K4M 750, -752, -753	06.01 ->	4	70	CSS1534	---
Kangoo 1.6 16V	K4M 830	02.08 ->	4	78	CSS1534	---
Kangoo 1.6 16V 4x4	K4M 750, -752, -753	10.01 ->	4	70	CSS1535	---
Kangoo 1.6 16V Hi-Flex	K4M 830	02.08 ->	4	78	CSS1534	---
Kangoo 1.9 dCi 4x4	F9Q 782, -790	10.01 ->	4	59	---	CSS1530
Kangoo Be Bop 1.5 dCi	K9K 804	06.09 ->	4	80	CSS1541	CSS1540
Kangoo Be Bop 1.5 dCi	K9K 806	02.09 ->	4	76	CSS1541	CSS1540
Kangoo Be Bop 1.5 dCi	K9K 808	06.09 ->	4	66	CSS1541	---
Kangoo Be Bop 1.5 dCi 75	K9K 802	09.10 ->	4	55	CSS1537	---
Kangoo Be Bop 1.5 dCi 75	K9K 802	09.10 ->	4	55	CSS1541	---
Kangoo Be Pop 1.6	K4M 830	02.09 ->	4	78	CSS1534	---
Kangoo Express 1.2 TCe 115	H5F 400	07.12 ->	4	84	CSS1544	---
Kangoo Express 1.5 dCi	K9K 800	02.08 ->	4	50	CSS1541	CSS1540
Kangoo Express 1.5 dCi	K9K 806	02.08 ->	4	76	CSS1541	CSS1540
Kangoo Express 1.5 dCi 110	K9K 636	09.13 ->	4	81	CSS1537	---
Kangoo Express 1.5 dCi 110	K9K 804	09.10 ->	4	80	CSS1537	---
Kangoo Express 1.5 dCi 110	K9K 804	09.10 ->	4	80	CSS1541	CSS1540
Kangoo Express 1.5 dCi 75	K9K 800, K9K 808	09.10 ->	4	55	CSS1537	---
Kangoo Express 1.5 dCi 75	K9K 808	09.10 ->	4	55	CSS1541	---
Kangoo Express 1.5 dCi 85	K9K 802, K9K 800	02.08 ->	4	63	CSS1541	CSS1540
Kangoo Express 1.5 dCi 90	K9K 808	06.09 ->	4	66	CSS1541	---
Kangoo Express 1.6	K7M 750	02.08 ->	4	64	CSS1532	---
Kangoo Express 1.6 16V	K4M 830	02.08 ->	4	78	CSS1534	---
Kangoo Express 1.6 16V LPG	K4M 834	02.08 ->	4	72	CSS1534	---
Kangoo Rapid 1.2	D7F 710, -720, -722, -726	03.98 ->	4	43	CSS1532	---
Kangoo Rapid 1.2 16V	D4F 712, D4F 714	10.01 ->	4	55	CSS1532	---
Kangoo Rapid 1.4	E7J 634, -635, -780, -701	03.98 ->	4	55	CSS1532	---
Kangoo Rapid 1.5 dCi	K9K 702, K9K 704, K9K 700	12.01 ->	4	48	---	CSS1540
Kangoo Rapid 1.5 dCi	K9K 704	12.02 ->	4	42	---	CSS1540

Typ Type	Motornummer Engine-No.	Baujahr Year	Zyl. Cyl.	KW	Kurbelwellen- sensor Crankshaft S.	Nocken- wellensensor Camshaft S.
Kangoo Rapid 1.5 dCi	K9K 716	10.05 ->	4	45	---	CSS1540
Kangoo Rapid 1.6 16V 4x4	K4M 750, -752, -753	10.01 ->	4	70	CSS1535	---
Kangoo Rapid 1.6 16V 4x4	K4M 750, K4M 753, K4M 752	10.01 -	4	70	CSS1542	---
Kangoo Rapid 1.9 dCi 4x4	F9Q 782, -790	10.01 ->	4	59	---	CSS1530
Kangoo Rapid D 55 1.9	F8Q 662	03.98 ->	4	40	CSS1534	---
Kangoo Rapid D 65 1.9	F8Q 630, F8Q 632	03.98 ->	4	47	CSS1534	---
Kangoo/Grand Kangoo 1.2 TCe 115	H5F 400	07.12 ->	4	84	CSS1544	---
Koleos 2.0 dCi	M9R 856, M9R 865, M9R 866	09.08 ->	4	110	---	CSS1540
Koleos 2.0 dCi 4x4	M9R 830	09.08 ->	4	127	---	CSS1540
Koleos 2.0 dCi 4x4	M9R 856, M9R 865, M9R 866	09.08 ->	4	110	---	CSS1540
Laguna Coupe 1.5 dCi	K9K 846	03.12 ->	4	81	CSS1541	---
Laguna Coupe 1.5 dCi	K9K 846	03.12 ->	4	81	CSS1537	---
Laguna Coupe 3.0 dCi	V9X 891	01.12 ->	6	177	CSS1537	---
Laguna I 1.6 16V	F4P 720, K4M 724	11.97 - 03.01	4	79	CSS1534	---
Laguna I 1.8	F3P 720, -724	11.93 - 03.01	4	66	CSS1529	---
Laguna I 1.8 16V	F4P 760	04.98 - 03.01	4	88	CSS1534	---
Laguna I 1.9 dCi	F9Q 718	09.99 - 03.01	4	79	---	CSS1530
Laguna I 2.0 16V	F4R 780	09.99 - 03.01	4	103	CSS1527	---
Laguna I 2.0 16V	F4R 780	09.99 - 03.01	4	103	CSS1534	---
Laguna I 2.0 16V	N7Q 700, -704	06.95 - 03.01	4	102	CSS1527	---
Laguna I 3.0	Z7X 760, -765	11.93 - 03.01	6	123	CSS1527	---
Laguna I 3.0 24V	L7X 700, L7X 701	03.97 - 10.03	6	140	CSS1501	---
Laguna I Grandtour 1.6 16V	K4M 720, K4M 724	11.97 - 03.01	4	79	CSS1534	---
Laguna I Grandtour 1.8	F3P 670, -678	09.95 - 03.01	4	66	CSS1529	---
Laguna I Grandtour 1.8 16V	F4P 760	04.98 - 03.01	4	88	CSS1534	---
Laguna I Grandtour 1.9 dCi	F9Q 718	09.99 - 03.01	4	79	---	CSS1530
Laguna I Grandtour 2.0 16V	F4R 780	09.99 - 03.01	4	103	CSS1534	---
Laguna I Grandtour 2.0 16V	N7Q 700, -704	09.95 - 03.01	4	102	CSS1527	---
Laguna I Grandtour 3.0	Z7X 765	02.96 - 03.01	6	123	CSS1527	---
Laguna I Grandtour 3.0 24V	L7X 700, L7X 701	03.97 - 03.01	6	140	CSS1501	---
Laguna II 1.6 16V	K4M 710, K4M 711	03.01 ->	4	79	CSS1534	---
Laguna II 1.6 16V	K4M 716	02.05 ->	4	82	---	CSS1540
Laguna II 1.8 16V	F4P 770, -771, -772, 773, 774	03.01 ->	4	85	CSS1535	---
Laguna II 1.8 16V	F4P 770, -771, -772, 773, 774	03.01 ->	4	85	CSS1534	---
Laguna II 1.8 16V	F4P 770, F4P 773	03.01 ->	4	88	CSS1535	---
Laguna II 1.8 16V	F4P 770, F4P 774	03.01 ->	4	89	CSS1534	---
Laguna II 1.9 dCi	F9Q 750, -756	03.01 ->	4	88	---	CSS1530
Laguna II 1.9 dCi	F9Q 754	10.01 ->	4	74	---	CSS1530
Laguna II 2.0 16V	F4R 712, -713, -714, -715	08.02 ->	4	99	CSS1534	---
Laguna II 2.0 16V IDE	F5R 700	04.01 ->	4	103	CSS1534	---
Laguna II 2.0 dCi	M9R 740	08.05 ->	4	110	---	CSS1540
Laguna II 2.0 dCi	M9R 760	01.06 ->	4	127	---	CSS1540
Laguna II 2.2 dCi	G9T 702	10.01 ->	4	110	---	CSS1530
Laguna II 3.0 V6 24V	L7X 731	03.01 ->	6	152	CSS1514	---
Laguna II Grandtour 1.6 16V	K4M 710, K4M 711	03.01 ->	4	79	CSS1534	---
Laguna II Grandtour 1.6 16V	K4M 716	02.05 ->	4	82	---	CSS1540
Laguna II Grandtour 1.8 16V	F4P 770, F4P 773	03.01 ->	4	88	CSS1535	---
Laguna II Grandtour 1.8 16V	F4P 771, -773, -774	03.01 ->	4	85	CSS1535	---
Laguna II Grandtour 1.8 16V	K4M 770, K4M 774	03.01 ->	4	89	CSS1534	---
Laguna II Grandtour 1.9 dCi	F9Q 750, -756	03.01 ->	4	88	---	CSS1530
Laguna II Grandtour 1.9 dCi	F9Q 754	10.01 ->	4	74	---	CSS1530
Laguna II Grandtour 2.0 16V	F4R 712, -713, -714, -715	08.02 ->	4	99	CSS1534	---
Laguna II Grandtour 2.0 16V IDE	F5R 700	04.01 ->	4	103	CSS1534	---
Laguna II Grandtour 2.0 dCi	M9R 740	08.05 ->	4	110	---	CSS1540
Laguna II Grandtour 2.0 dCi	M9R 760	01.06 ->	4	127	---	CSS1540
Laguna II Grandtour 2.2 dCi	G9T 702	10.01 ->	4	110	---	CSS1530
Laguna II Grandtour 3.0 V6 24V	L7X 731	03.01 ->	6	152	CSS1514	---
Laguna III 1.5 dCi	K9K 780	10.07 ->	4	81	CSS1541	CSS1540
Laguna III 1.6 16V	K4M 824	10.07 ->	4	81	---	CSS1540

Typ Type	Motornummer Engine-No.	Baujahr Year	Zyl. Cyl.	KW	Kurbelwellen- sensor Crankshaft S.	Nocken- wellensensor Camshaft S.
Laguna III 2.0 dCi	M9R 744, M9R 802, M9R 742	10.07 ->	4	96	---	CSS1540
Laguna III 2.0 dCi	M9R 805, M9R 814, M9R 802	10.07 ->	4	110	---	CSS1540
Laguna III 2.0 dCi	M9R 809, M9R 815, M9R 800	01.08 ->	4	127	---	CSS1540
Laguna III 2.0 dCi GT	M9R 816	03.08 ->	4	131	---	CSS1540
Laguna III 3.0 dCi	V9X 791, V9X 891	09.08 ->	6	173	---	CSS1540
Laguna III Grandtour 1.5 dCi	K9K 780	10.07 ->	4	81	CSS1541	CSS1540
Laguna III Grandtour 1.6 16V	K4M 824	10.07 ->	4	81	---	CSS1540
Laguna III Grandtour 2.0 dCi	M9R 805, M9R 814, M9R 802	10.07 ->	4	110	---	CSS1540
Laguna III Grandtour 2.0 dCi	M9R 809, M9R 815, M9R 800	01.08 ->	4	127	---	CSS1540
Laguna III Grandtour 2.0 dCi GT	M9R 820, M9R 816	03.08 ->	4	131	---	CSS1540
Laguna III Grandtour 3.0 dCi	V9X 791, V9X 891	09.08 ->	6	173	---	CSS1540
Latitude 1.5 dCi	K9K 782	07.10 ->	4	81	CSS1537	---
Latitude 2.0 dCi	---	02.11 ->	4	130	---	CSS1540
Latitude 2.0 dCi 150	M9R 824, M9R 846	02.11 ->	4	110	---	CSS1540
Latitude 2.0 dCi 175	M9R 804, M9R 844, M9R 817	05.11 ->	4	127	---	CSS1540
Latitude 3.0 dCi 240	V9X 891	02.11 ->	6	177	---	CSS1540
Latitude 3.0 dCi 240	V9X 891	02.11 ->	6	177	CSS1537	---
Logan I 1.4	K7J 710	10.07 ->	4	55	CSS1532	---
Logan I 1.4	K7J 710	09.04 ->	4	55	CSS1543	---
Logan I 1.5 dCi	K9K 790, K9K 794, K9K 700	06.11 ->	4	48	---	CSS1540
Logan I 1.5 dCi	K9K 792	04.07 ->	4	50	CSS1541	CSS1540
Logan I 1.5 dCi	K9K 796	02.08 ->	4	63	CSS1541	CSS1540
Logan I 1.6	K4M 690	04.07 ->	4	77	CSS1534	---
Logan I 1.6	K4M 690	04.07 ->	4	77	CSS1542	---
Logan I 1.6	K4M 697	04.07 ->	4	77	CSS1534	---
Logan I 1.6	K7M 710	04.07 ->	4	64	CSS1532	---
Logan I 1.6	K7M 710	09.04 ->	4	64	CSS1543	---
Mascott 120.35	DXi 3, ZD3 A 600	05.04 - 10.10	4	85	---	CSS1540
Master II 1.9 dCi 80	F9Q 772	11.01 ->	4	60	---	CSS1530
Master II 2.2 dCi 90	G9T 722	09.00 ->	4	66	---	CSS1530
Master II 2.5 dCi 120	G9U 720, -754	10.01 ->	4	84	---	CSS1530
Master III 2.3 dCi 150	M9T 880	10.12 ->	4	110	---	CSS1540
Master III 2.3 dCi FWD	M9T 680	02.11 ->	4	107	---	CSS1540
Megane Cabriolet 1.4 16V	K4J 714, K4J 750	03.99 - 08.03	4	70	CSS1534	---
Megane Cabriolet 1.6 16V	K4M 700, -701, -708	03.99 - 08.03	4	79	CSS1535	---
Megane Cabriolet 1.6 e	K7M 702, K7M 703	10.96 - 03.99	4	66	CSS1532	---
Megane Cabriolet 1.6e	K7M 702, -703	10.96 - 03.99	4	66	CSS1529	---
Megane Cabriolet 2.0 16V	F7R 710, -714	10.96 - 11.99	4	108	CSS1527	---
Megane Cabriolet 2.0 16V IDE	F5R 740	11.99 - 08.03	4	103	CSS1534	---
Megane Cabriolet 2.0 i	F3R 791, F3R 796	03.99 - 08.03	4	80	CSS1535	---
Megane CC 1.2 TCe	H5F 404	01.13 ->	4	97	CSS1544	---
Megane CC 1.4 TCe	H4J 700	06.10 ->	4	96	CSS1544	---
Megane CC 1.9 dCi	F9Q 870	06.10 ->	4	96	---	CSS1540
Megane CC 2.0 dCi	M9R 610	06.10 ->	4	118	---	CSS1540
Megane Classic 1.4	E7J 626, E7J 764	09.96 - 08.03	4	55	CSS1532	---
Megane Classic 1.4 16V	K4J 714, K4J 750	03.99 - 08.03	4	70	CSS1534	---
Megane Classic 1.6 16V	K4M 700, -701, -708	03.99 - 08.03	4	79	CSS1535	---
Megane Classic 1.6 16V	K4M 700, -701, -708	03.99 - 08.03	4	79	CSS1534	---
Megane Classic 1.6 e	K7M 702, -703, -790	09.96 - 03.99	4	66	CSS1533	---
Megane Classic 1.6 e	K7M 702, -703, -790	01.96 - 03.99	4	66	CSS1533	---
Megane Classic 1.6 e	K7M 702, K7M 703	09.96 - 03.99	4	66	CSS1534	---
Megane Classic 1.6 i	K7M 720	09.96 - 03.99	4	55	CSS1534	---
Megane Classic 1.6e	K7M 702, -703, -790	09.96 - 03.99	4	66	CSS1529	---
Megane Classic 1.8 16V	F4P 720, K4M 722	01.01 - 08.03	4	85	CSS1534	---
Megane Classic 1.9 dT	FBQ 784, -786	09.96 - 08.03	4	66	CSS1527	---
Megane Classic 1.9 TDI	F8Q 784	09.96 - 08.03	4	69	CSS1527	---
Megane Classic 2.0i	F3R 750, -751	09.96 - 08.03	4	84	CSS1527	---
Megane Classic 2.0i	F3R 752, F3R 796	03.99 - 08.03	4	80	CSS1527	---
Megane Coach 1.4 16V	K4J 714, K4J 750	03.99 - 08.03	4	70	CSS1534	---

Typ Type	Motornummer Engine-No.	Baujahr Year	Zyl. Cyl.	KW	Kurbelwellen- sensor Crankshaft S.	Nocken- wellensensor Camshaft S.
Megane Coach 1.6 16V	K4M 700, -701, -708	03.99 - 08.03	4	79	CSS1535	---
Megane Coach 1.6 e	K7M 702, K7M 703	03.96 - 03.99	4	66	CSS1532	---
Megane Coach 1.6e	K7M 702, -703	03.96 - 03.99	4	66	CSS1529	---
Megane Coach 2.0 16V	F7R 710, -714	03.96 - 11.99	4	108	CSS1527	---
Megane Coach 2.0 16V	F7R 710, F7R 714	03.96 - 11.99	4	108	CSS1532	---
Megane Coach 2.0 i	F3R 750, F3R 751	03.96 - 08.03	4	84	CSS1532	---
Megane Coach 2.0i	F3R 750, -751	03.96 - 08.03	4	84	CSS1527	---
Megane Coach 2.0i	F3R 791, F3R 796	03.99 - 08.03	4	80	CSS1527	---
Megane Grandtour 1.4 16V	K4J 714, K4J 750	03.99 - 08.03	4	70	CSS1534	---
Megane Grandtour 1.4 e	E7J 626	03.99 - 08.03	4	55	CSS1534	---
Megane Grandtour 1.6	K4M 700, -701, -704, -708	03.99 - 08.03	4	79	CSS1535	---
Megane Grandtour 1.6 16V	K4M 700, -701, -704, -708	03.99 - 08.03	4	79	CSS1534	---
Megane I 1.4 16V	K4J 714, K4J 750	03.99 - 08.03	4	70	CSS1534	---
Megane I 1.4 e	E7J 626, E7J 764	01.96 - 08.03	4	55	CSS1532	---
Megane I 1.4 Eco	E7J 624	01.96 - 03.99	4	52	CSS1532	---
Megane I 1.6 16V	K4M 700, -701, -704, -708	03.99 - 08.03	4	79	CSS1535	---
Megane I 1.6 e	K7M 702, -703, -790	01.96 - 03.99	4	66	CSS1532	---
Megane I 1.6 i	K7M 720	01.96 - 03.99	4	55	CSS1532	---
Megane I 1.6e	K7M 702, -703, -790	01.96 - 03.99	4	66	CSS1529	---
Megane I 1.6i	K7M 720	01.96 - 03.99	4	55	CSS1529	---
Megane I 1.8 16V	F4P 720, F4P 722	01.01 - 08.03	4	85	CSS1534	---
Megane I 1.9 dCi	F9Q 732, -733	02.01 - 08.03	4	75	---	CSS1530
Megane I 1.9 dT	F8Q 784, -786	01.96 - 08.03	4	66	CSS1527	---
Megane I 1.9 TDI	F8Q 784	09.96 - 08.03	4	69	CSS1527	---
Megane I 2.0i	F3R 750, -751	03.99 - 08.03	4	80	CSS1527	---
Megane I 2.0i	F3R 750, -751	09.96 - 08.03	4	84	CSS1527	---
Megane I Classic 1.9 dCi	F9Q 732, -733	02.01 - 08.03	4	75	---	CSS1530
Megane I Coach 1.9 dCi	F9Q 732, -733	02.01 - 08.03	4	75	---	CSS1530
Megane I Grandtour 1.9 dCi	F9Q 732, -733	02.01 - 08.03	4	75	---	CSS1530
Megane II 1.4 16V	K4J 732	10.03 - 02.08	4	60	CSS1534	---
Megane II 1.5 dCi	K9K 722	11.02 - 02.08	4	60	---	CSS1540
Megane II 1.5 dCi	K9K 724	05.05 - 02.08	4	63	CSS1541	CSS1540
Megane II 1.5 dCi	K9K 729, K9K 728	10.03 - 03.06	4	74	CSS1541	CSS1540
Megane II 1.5 dCi	K9K 734	01.07 - 02.08	4	76	CSS1541	CSS1540
Megane II 1.5 dCi	K9K 734, K9K 732	05.05 - 06.08	4	78	CSS1541	CSS1540
Megane II 1.6	K4M 760	01.07 ->	4	82	CSS1534	---
Megane II 1.6	K4M 760	11.02 - 02.08	4	83	CSS1535	---
Megane II 1.6	K4M 788	06.05 - 02.08	4	77	CSS1534	---
Megane II 1.6 16V	K4M 760	11.02 - 02.08	4	83	CSS1534	CSS1540
Megane II 1.6 16V	K4M 812, K4M 760, K4M 813	01.06 - 06.08	4	82	---	CSS1540
Megane II 1.9 dCi	F9Q 800	11.02 - 02.08	4	88	---	CSS1530
Megane II 2.0 dCi	M9R 722, M9R 700	09.05 - 02.08	4	110	---	CSS1540
Megane II 2.0 dCi	M9R 724	01.07 - 02.08	4	127	---	CSS1540
Megane II Coupe-Cabriolet 1.6	K4M 760, K4M 761	09.03 - 03.09	4	83	CSS1534	---
Megane II Coupe-Cabriolet 1.9 dCi	F9Q 800	09.03 - 03.09	4	88	---	CSS1530
Megane II Grandtour 1.5 dCi	K9K 722	08.03 - 05.06	4	60	---	CSS1540
Megane II Grandtour 1.5 dCi	K9K 724	05.05 - 07.09	4	63	---	CSS1540
Megane II Grandtour 1.5 dCi	K9K 728	01.07 - 07.09	4	76	CSS1541	CSS1540
Megane II Grandtour 1.5 dCi	K9K 729, K9K 728	02.04 - 03.06	4	74	---	CSS1540
Megane II Grandtour 1.5 dCi	K9K 734, K9K 732	05.05 - 06.08	4	78	CSS1541	CSS1540
Megane II Grandtour 1.6	K4M 760, K4M 761	08.03 - 07.09	4	83	CSS1534	CSS1540
Megane II Grandtour 1.6	K4M 760, K4M 761, K4M D 812	01.07 ->	4	82	CSS1534	---
Megane II Grandtour 1.6 16V	K4M 812, K4M 760, K4M 761	01.06 - 08.09	4	82	---	CSS1540
Megane II Grandtour 1.9 dCi	F9Q 800	08.03 - 07.09	4	88	---	CSS1530
Megane II Grandtour 2.0 dCi	M9R 722, M9R 700	09.05 - 07.09	4	110	---	CSS1540
Megane III 1.5 dCi	K9K 636,-836,-837,-846	02.09 ->	4	81	CSS1541	---
Megane III 1.5 dCi	K9K 830	12.09 ->	4	63	CSS1537	---
Megane III 1.5 dCi	K9K 830	12.09 ->	4	63	CSS1541	---
Megane III 1.5 dCi	K9K 836	02.09 ->	4	81	CSS1537	---

Typ Type	Motornummer Engine-No.	Baujahr Year	Zyl. Cyl.	KW	Kurbelwellen- sensor Crankshaft S.	Nocken- wellensensor Camshaft S.
Megane III 1.5 dCi	K9K 846	11.13 ->	4	70	CSS1537	---
Megane III 1.5 dCi	K9K G 832	02.09 ->	4	78	CSS1541	---
Megane III 1.5 dCi	K9K H 834	11.08 ->	4	66	CSS1537	---
Megane III 1.5 dCi	K9K H 834	11.08 ->	4	66	CSS1541	---
Megane III 1.6 16V	K4M 848	11.08 ->	4	74	CSS1542	CSS1540
Megane III 1.6 16V	K4M 848	11.08 ->	4	74	CSS1534	---
Megane III 1.6 dCi	R9M 402, R9M 404	04.11 ->	4	96	CSS1537	---
Megane III 1.9 dCi	F9Q 870, F9Q 872	11.08 ->	4	96	CSS1537	CSS1540
Megane III 2.0 dCi	M9R 610	04.09 ->	4	118	---	CSS1540
Megane III 2.0 dCi	M9R 610	07.12 ->	4	120	---	CSS1540
Megane III 2.0 dCi	M9R 615	10.10 ->	4	110	---	CSS1540
Megane III Coupe 1.2 TCe	H5F 400	03.12 ->	4	85	CSS1544	---
Megane III Coupe 1.2 TCe	H5F 404	01.13 ->	4	97	CSS1544	---
Megane III Coupe 1.4 TCe	H4J 700	04.09 ->	4	96	CSS1544	---
Megane III Coupe 1.5 dCi	K9K 846	07.14 ->	4	70	CSS1537	---
Megane III Grandtour 1.2 TCe	H5F 400	03.12 ->	4	85	CSS1544	---
Megane III Grandtour 1.2 TCe	H5F 404	01.13 ->	4	97	CSS1544	---
Megane III Grandtour 1.4 TCe	H4J 700	05.09 ->	4	96	CSS1544	---
Megane III Grandtour 1.5 dCi	K9K 636,-836,-837,-846	02.09 ->	4	81	CSS1541	---
Megane III Grandtour 1.5 dCi	K9K 834	05.09 ->	4	66	CSS1541	---
Megane III Grandtour 1.5 dCi	K9K 836, K9K 846	02.09 ->	4	78	CSS1541	---
Megane III Grandtour 1.5 dCi	K9K 846	11.13 ->	4	70	CSS1537	---
Megane III Grandtour 1.6 16V	K4M 848	05.09 ->	4	74	CSS1542	CSS1540
Megane III Grandtour 1.6 16V	K4M P 848	05.09 ->	4	74	CSS1534	---
Megane III Grandtour 1.6 dCi	R9M 402, R9M 404	04.11 ->	4	96	CSS1537	---
Megane III Grandtour 1.9 dCi	F9Q 872, F9Q 870	05.09 ->	4	96	---	CSS1540
Megane III Grandtour 2.0 dCi	M9R 610	04.09 ->	4	118	---	CSS1540
Megane III Grandtour 2.0 dCi	M9R 610	07.12 ->	4	120	---	CSS1540
Megane III Grandtour 2.0 dCi	M9R 615	10.10 ->	4	110	---	CSS1540
Megane IV 1.2 TCe 100	H5F 408	11.15 ->	4	74	CSS1544	---
Megane IV 1.2 TCe 130	H5F 408	11.15 ->	4	97	CSS1544	---
Megane IV Grandtour 1.2 TCe 100	H5F 408	04.16 ->	4	74	CSS1544	---
Megane IV Grandtour 1.2 TCe 130	H5F 408	04.16 ->	4	97	CSS1544	---
Megane Scénic 1.4 16V	K4J 714, K4J 750	09.99 - 08.03	4	70	CSS1534	---
Megane Scénic 1.4 i	E7J 764	01.97 - 09.99	4	55	CSS1532	---
Megane Scénic 1.6 e	K7M 702, K7M 703	01.97 - 09.99	4	66	CSS1532	---
Megane Scénic 1.6 e	K7M 702, K7M 703	01.97 - 09.99	4	66	CSS1533	---
Megane Scénic 1.6 e	K7M 702, K7M 703	01.97 - 09.99	4	66	CSS1534	---
Megane Scénic 1.6 i	K7M 720	01.97 - 09.99	4	55	CSS1532	---
Megane Scénic 1.6 i	K7M 720	01.97 - 09.99	4	55	CSS1534	---
Megane Scénic 1.9 D	F8Q 790	03.97 - 09.99	4	47	CSS1532	---
Megane Scénic 1.9 dT	F8Q 784, -786	01.97 - 09.99	4	66	CSS1527	---
Megane Scénic 1.9 dT	F8Q 784, F8Q 786	01.97 - 09.99	4	66	CSS1532	---
Megane Scénic 1.9 dTi	F9Q 730, F9Q 734	04.97 - 09.99	4	72	CSS1532	---
Megane Scénic 2.0 i	F3R 750, F3R 751	01.97 - 09.99	4	84	CSS1532	---
Megane Scénic 2.0i	F4R 750, -751	01.97 - 09.99	4	84	CSS1527	---
Modus / Grand Modus 1.2	D4F 764	12.04 ->	4	58	---	CSS1540
Modus / Grand Modus 1.2	D4F 786	04.11 ->	4	76	CSS1532	---
Modus / Grand Modus 1.5 dCi	K9K 750	09.04 ->	4	60	---	CSS1540
Modus / Grand Modus 1.5 dCi	K9K 752	12.04 ->	4	48	---	CSS1540
Modus / Grand Modus 1.5 dCi	K9K 764	05.05 ->	4	78	---	CSS1540
Modus / Grand Modus 1.5 dCi	K9K 766, K9K 760	12.04 ->	4	63	CSS1541	CSS1540
Modus / Grand Modus 1.5 dCi	K9K 768, K9K 762	12.04 ->	4	50	CSS1541	CSS1540
Modus / Grand Modus 1.5 dCi	K9K 772	05.07 ->	4	76	CSS1541	CSS1540
Modus / Grand Modus 1.5 dCi 75	K9K 770	10.10 ->	4	55	CSS1537	---
Modus / Grand Modus 1.5 dCi 90	K9K 750	10.10 ->	4	65	CSS1536	---
Modus / Grand Modus 1.6	K4M 790, K4M 800, K4M 801	12.04 ->	4	82	---	CSS1540
Modus / Grand Modus 1.6	K4M 794	12.04 ->	4	65	---	CSS1540
Modus 1.2	D4F 740	12.04 ->	4	55	CSS1532	---

Typ Type	Motornummer Engine-No.	Baujahr Year	Zyl. Cyl.	KW	Kurbelwellen- sensor Crankshaft S.	Nocken- wellensensor Camshaft S.
Modus 1.2	D4F 786	04.11 ->	4	76	CSS1532	---
Modus 1.2 16V	D4F 784	05.07 ->	4	74	CSS1532	---
Modus 1.2 16V Hi-Flex	D4F 740	10.08 ->	4	55	CSS1532	---
Rapid 1.4 Kat.	C3J700, -702, -760, -762	08.88 - 03.98	4	43	CSS1524	---
Safrane I 2.0 12V	J7R 734, -735	04.92 - 07.96	4	97	CSS1527	---
Safrane I 2.2	J7T 760, -761	04.92 - 07.96	4	101	CSS1527	---
Safrane I 2.2	J7T 762	04.92 - 07.96	4	79	CSS1527	---
Safrane I 3.0 Biturbo 4x4	Z7X 726	02.93 - 07.96	6	193	CSS1527	---
Safrane I 3.0 V6	Z7X 721, -722, -723	12.92 - 07.96	6	123	CSS1527	---
Safrane II 3.0 V6	Z7X 721, -722, -723	07.96 - 12.00	6	123	CSS1527	---
Safrane III 2.9 24V	L7X 713	03.99 - 12.00	6	140	CSS1501	---
Sandero / Stepway I 1.4	K7J 710	02.09 ->	4	55	CSS1543	---
Sandero / Stepway I 1.6	K7M 710	02.09 ->	4	64	CSS1543	---
Scénic I 1.6 16V	K4M 700, -701, -704, -708	09.99 - 08.03	4	79	CSS1535	---
Scénic I 1.8 16V	F4P 720	01.01 - 08.03	4	85	CSS1534	---
Scénic I 1.9 dCi	F9Q 732, -733	09.99 - 08.03	4	75	---	CSS1530
Scénic I 2.0 16V	F4P 740	07.00 - 08.03	4	102	CSS1534	---
Scénic I 2.0 16V	F4R 740, F4R 741	07.00 - 08.03	4	102	CSS1535	---
Scénic I 2.0 16V IDE	F4R 740, -741, -744	09.99 - 08.03	4	103	CSS1534	---
Scénic I 2.0 16V RX4	F4R 744	06.00 - 08.03	4	102	CSS1535	---
Scénic II 1.4	K49730	06.03 ->	4	72	CSS1534	---
Scénic II 1.5 dCi	K9K 722	06.03 ->	4	60	---	CSS1540
Scénic II 1.5 dCi	K9K 724	05.05 ->	4	63	---	CSS1540
Scénic II 1.5 dCi	K9K 724	05.05 ->	4	63	CSS1541	---
Scénic II 1.5 dCi	K9K 729, K9K 728	11.03 ->	4	74	---	CSS1540
Scénic II 1.5 dCi	K9K 729, K9K 728	11.03 ->	4	74	CSS1541	---
Scénic II 1.5 dCi	K9K 732	05.05 ->	4	78	---	CSS1540
Scénic II 1.5 dCi	K9K 732	05.05 ->	4	78	CSS1541	---
Scénic II 1.5 dCi	K9K 734	01.07 ->	4	76	CSS1541	---
Scénic II 1.5 dCi	K9K 734	01.07 ->	4	76	---	CSS1540
Scénic II 1.6	K4M 761, K4M 782	06.03 ->	4	83	CSS1535	CSS1540
Scénic II 1.6 16V	K4M 812, K4M 9 766	01.07 ->	4	82	CSS1534	---
Scénic II 1.6 16V	K4M 812, K4M 766, K4M 706	10.05 ->	4	82	---	CSS1540
Scénic II 1.9 dCi	F9Q 812	06.03 ->	4	88	---	CSS1530
Scénic II 2.0	F4R 771, F4R 770	06.03 ->	4	99	---	CSS1540
Scénic II 2.0 16V Turbo	F4R 776	05.04 ->	4	120	---	CSS1540
Scénic II 2.0 dCi	M9R 721, M9R 722, M9R 700	09.05 ->	4	110	---	CSS1540
Scénic III 1.2 TCe	H5F 400	04.12 ->	4	85	CSS1544	---
Scénic III 1.2 TCe	H5F 404	01.13 ->	4	97	CSS1544	---
Scénic III 1.4 16V	H4J 700	02.09 ->	4	96	CSS1544	---
Scénic III 1.5 dCi	F9Q 870	02.09 ->	4	96	CSS1537	---
Scénic III 1.5 dCi	K9K 830	04.09 ->	4	63	CSS1541	---
Scénic III 1.5 dCi	K9K 832	02.09 ->	4	78	CSS1537	---
Scénic III 1.5 dCi	K9K 832	02.09 ->	4	78	CSS1541	---
Scénic III 1.5 dCi	K9K 836, K9K 837, K9K 636	04.09 ->	4	81	CSS1541	---
Scénic III 1.5 dCi	K9K 846	11.10 ->	4	70	CSS1537	---
Scénic III 1.6 dCi	R9M 402, R9M 404	04.11 ->	4	96	CSS1537	---
Scénic III 1.9 dCi	F9Q 872, F9Q 870	02.09 ->	4	96	---	CSS1540
Scénic III 2.0 dCi	M9R 610	04.09 ->	4	118	---	CSS1540
Scénic III 2.0 dCi	M9R 615	02.09 ->	4	110	---	CSS1540
Super 5 1.4 Kat.	C3J 700, -702, -760	10.85 - 12.96	4	43	CSS1526	---
Super 5 1.4 Kat.	C3J700, -702, -760, -762	10.85 - 12.96	4	43	CSS1524	---
Super 5 1.7	F3N 716, -717	10.86 - 03.95	4	54	CSS1526	---
Thalia I 1.5 dCi	K9K 700	04.02 ->	4	48	---	CSS1540
Thalia I 1.5 dCi	K9K 702	06.01 ->	4	60	---	CSS1540
Thalia I 1.5 dCi	K9K 714, K9K 700	02.03 ->	4	50	---	CSS1540
Thalia I 1.5 dCi	K9K 740	06.05 ->	4	47	CSS1541	CSS1540
Thalia II 1.5 dCi	K9K 718	09.08 ->	4	62	CSS1541	---
Thalia II 1.6 16V	K4M 743	09.08 ->	4	77	CSS1542	---

Typ Type	Motornummer Engine-No.	Baujahr Year	Zyl. Cyl.	KW	Kurbelwellen- sensor Crankshaft S.	Nocken- wellensensor Camshaft S.
Trafic I 1.9 D	F8Q 606	06.97 - 03.01	4	44	CSS1534	---
Trafic II 1.9 dCi 100	F9Q 760	03.01 ->	4	74	---	CSS1530
Trafic II 1.9 dCi 80	F9Q 762	03.01 ->	4	60	---	CSS1530
Trafic II 2.0 dCi 90	M9R 782	08.06 ->	4	66	---	CSS1540
Trafic II 2.5 dCi	G9U 730	05.03 ->	4	99	---	CSS1530
Trafic III 1.6 dCi 115	R9M 408	05.14 ->	4	85	CSS1537	---
Trafic III 1.6 dCi 120	R9M 450	05.14 ->	4	88	CSS1537	---
Trafic III 1.6 dCi 140	R9M 450	05.14 ->	4	103	CSS1537	---
Trafic III 1.6 dCi 145	R9M 452	07.15 ->	4	107	CSS1537	---
Trafic III 1.6 dCi 90	R9M 408	05.14 ->	4	66	CSS1537	---
Trafic III 1.6 dCi 95	R9M 413	07.15 ->	4	70	CSS1537	---
Twingo I 1.2	C3G 700, -702	03.93 - 10.96	4	40	CSS1529	---
Twingo I 1.2	D7F 700, -701	05.96 ->	4	40	CSS1529	---
Twingo I 1.2	D7F 700, -701, -702, -703, -704	05.96 ->	4	43	CSS1529	---
Twingo I 1.2	D7F 700, -701, -702, -703, -704	05.96 ->	4	43	CSS1532	---
Twingo I 1.2	D7F 700, D7F 701	05.96 ->	4	40	CSS1532	---
Twingo I 1.2	D7F 800	03.07 ->	4	43	CSS1532	---
Twingo I 1.2 16V	D4F 702, D4F 704	01.01 ->	4	55	CSS1532	---
Twingo II 1.2	D7F 800	03.07 ->	4	43	CSS1543	---
Twingo II 1.2 16V	D4F 764, D4F 772	03.07 ->	4	55	CSS1532	---
Twingo II 1.2 16V	D4F 764, D4F 772, D4F 770	03.07 ->	4	55	CSS1543	---
Twingo II 1.2 16V	D4F 772	03.07 ->	4	56	CSS1532	---
Twingo II 1.2 16V	D4F 772	03.07 ->	4	56	CSS1543	---
Twingo II 1.2 Tce 100	D4F 780, D4F 782	02.11 ->	4	75	CSS1543	---
Twingo II 1.2 Turbo	D4F 780	03.07 ->	4	74	CSS1532	---
Twingo II 1.2 Turbo	D4F 780, D4F 782	03.07 ->	4	74	CSS1543	---
Twingo II 1.5 dCi	K9K 718	04.08 ->	4	62	CSS1537	---
Twingo II 1.5 dCi	K9K 718	04.08 ->	4	62	CSS1541	---
Twingo II 1.5 dCi	K9K 740	03.07 ->	4	47	CSS1537	---
Twingo II 1.5 dCi	K9K 740	03.07 ->	4	47	CSS1541	CSS1540
Twingo II 1.5 dCi 75	K9K 820	10.10 ->	4	55	CSS1537	---
Twingo II 1.5 dCi 90	K9K 820	10.10 ->	4	63	CSS1537	---
Twingo II 1.6 RS	K4M 854	05.08 ->	4	98	---	CSS1540
Twingo III 0.9 TCe 90	H4B 401	09.14 ->	3	66	CSS1544	---
Twingo III 0.9 Tce 90	H4B 401	09.14 ->	3	66	CSS1543	---
Twingo III 1.0 SCe 70	H4D 400	09.14 ->	3	52	CSS1544	---
Twingo III 1.0 Sce 70	H4D 400	09.14 ->	3	52	CSS1543	---
Vel Satis 2.0 dCi	M9R 760	08.05 ->	4	110	---	CSS1540
Vel Satis 2.0 dCi	M9R 762, M9R 763, M9R 760	01.06 ->	4	127	---	CSS1540
Vel Satis 2.2 dCi	G9T 702	06.02 ->	4	110	---	CSS1530
Wind 1.2	D4F 782	07.10 ->	4	74	CSS1543	---
Wind 1.2 Tce 100	D4F 780	02.11 ->	4	75	CSS1543	---
Wind 1.6	K4M 854	07.10 ->	4	98	---	CSS1540
<b>Saab</b>						
900 II 2.0 -16 Turbo	B204L	07.93 - 02.98	4	136	CSS707	---
900 II Coupe 2.0 -16 Turbo	B204L	12.93 - 02.98	4	136	CSS707	---
900 II Coupe 2.0 i	B204L	08.94 - 02.98	4	96	CSS707	---
9-3 1.9 TiD	Z 19 DT	09.04 ->	4	88	CSS1317	---
9-3 1.9 TiD	Z 19 DTJ	03.05 ->	4	88	CSS1317	---
9-3 2.2 TiD	D223L	11.00 - 09.02	4	92	CSS709	---
9-3 2.2 TiD	D223L	02.98 - 11.00	4	85	CSS709	---
9-3 2.2 TiD	D223L	09.02 ->	4	92	CSS709	---
9-5 2.2 TiD	D223L	03.02 - 12.09	4	88	CSS709	---
<b>Seat</b>						
Alhambra 1.4 TSI	CZDA	05.15 ->	4	110	---	CSS308
Alhambra 1.8 T 20V	AJH	10.97 - 03.10	4	110	CSS311	---
Alhambra 1.8 T 20V	AWC	10.97 - 03.10	4	110	CSS326	---

Typ Type	Motornummer Engine-No.	Baujahr Year	Zyl. Cyl.	KW	Kurbelwellen- sensor Crankshaft S.	Nocken- wellensensor Camshaft S.
Alhambra 1.8 TSI	CDA A	11.12 ->	4	118	CSS313	---
Alhambra 1.9 TDI	ANU, 1Z, AHU	04.96 - 03.10	4	66	---	CSS328
Alhambra 1.9 TDI	ASZ	11.02 - 11,08	4	96	---	CSS328
Alhambra 1.9 TDI	BVK, AUY	06.00 - 03.10	4	85	---	CSS328
Alhambra 1.9 TDI 4motion	BVK, AUY	06.00 - 03.10	4	85	---	CSS328
Alhambra 2.0 i	ADY, ATM	04.96 - 03.10	4	85	CSS309	CSS316
Alhambra 2.0 TDI	BRT	11.05 - 03.10	4	103	---	CSS329
Alhambra 2.0 TDI	CFFA	06.10 - 05.11	4	100	CSS322	---
Alhambra 2.0 TDI	CFFB	06.10 ->	4	103	CSS322	---
Alhambra 2.0 TDI	CFGB	06.10 ->	4	125	CSS322	---
Alhambra 2.0 TSI	CCZA	11.10 ->	4	147	CSS313	CSS324
Alhambra 2.8 V6	AUE, AYL	06.00 - 03.10	6	150	---	CSS323
Alhambra 2.8 V6 4motion	AUE, AYL	06.00 - 03.10	6	150	---	CSS323
Alhanbra 2.0 i	ATM, ADY	04.96 - 03.10	4	85	CSS326	---
Altea 1.2 TSI	CBZB	04.10 ->	4	77	CSS322	CSS300
Altea 1.4 16V	BXW, CGGB	05.06 ->	4	63	CSS322	CSS307
Altea 1.4 TSI	CAXC	11.07 ->	4	92	CSS322	CSS300
Altea 1.6	BGU, CCSA, BSF, CMXA, BSE	03.04 ->	4	75	CSS325	CSS303
Altea 1.6 LPG	CHGA	09.09 ->	4	75	CSS325	CSS303
Altea 1.6 TDI	CAYB	11.10 ->	4	66	CSS322	---
Altea 1.6 TDI	CAYC	10.09 ->	4	77	CSS322	---
Altea 1.8 TFSI	BYT, BZB, CDA A	01.07 ->	4	118	CSS313	CSS324
Altea 1.9 TDI	BXE, BKC, BJB, BLS	04.04 ->	4	77	---	CSS329
Altea 1.9 TDI	BXF	08.09 ->	4	66	---	CSS329
Altea 2.0 FSI	BLR, BLY, BVY, BVZ	05.04 - 03.09	4	110	---	CSS302
Altea 2.0 FSI	BLR, BLY, BVZ, BVY	05.04 - 03.09	4	110	CSS326	---
Altea 2.0 TDI	AZV	03.04 - 05.09	4	100	---	CSS330
Altea 2.0 TDI	BMM	11.05 ->	4	103	---	CSS329
Altea 2.0 TDI	BMW, CEGA	03.06 ->	4	125	CSS322	CSS330
Altea 2.0 TDI 16V	CFHC, BKD	03.04 ->	4	103	CSS322	CSS330
Altea 2.0 TFSI	BWA	04.06 - 05.09	4	147	CSS325	CSS302
Altea XL 1.6	CCSA, BSF, CMXA, BSE	10.06 ->	4	75	CSS325	---
Altea XL 1.6 LPG	CHGA	09.09 ->	4	75	CSS325	---
Altea XL 1.8 TFSI	BYT, BZB, CDA A	01.07 ->	4	118	CSS313	---
Altea XL 1.9 TDI	BXE, BKC, BLS	10.06 ->	4	77	---	CSS329
Altea XL 1.9 TDI	BXF	08.09 ->	4	66	---	CSS329
Altea XL 2.0 FSI	BVZ, BVY	11.06 - 03.09	4	110	CSS326	CSS302
Altea XL 2.0 TDI	AZV	11.06 - 03.09	4	100	---	CSS330
Altea XL 2.0 TDI	BMM	10.06 ->	4	103	---	CSS329
Altea XL 2.0 TDI	CEGA, BMN	06.07 ->	4	125	---	CSS330
Altea XL 2.0 TDI 16V	CFHC, BKD	10.06 ->	4	103	---	CSS330
Altea XL 2.0 TDI 4x4	BMM	06.07 ->	4	103	---	CSS329
Altea XL 2.0 TDI 4x4	CEGA, BMN, CFJA	06.07 ->	4	125	---	CSS330
Altea XL 2.0 TFSI	BWA	10.06 - 05.09	4	147	---	CSS302
Altea XL 2.0 TFSI 4x4	CCZB	05.09 ->	4	155	CSS313	---
Arosa 1.0	AER, AHT, ALD, ALL, ANV, AUC	05.97 - 06.04	4	37	---	CSS300
Arosa 1.4	AEX, AKK, AKV, ANW, APQ	05.97 - 06.04	4	44	---	CSS300
Arosa 1.4 16V	AFK, ANM, AQQ, AUB	01.00 - 06.04	4	74	---	CSS301
Arosa 1.4 TDI	AMF	01.00 - 06.04	3	55	---	CSS328
Ateca 1.0 TSI	CHZJ	05.16 ->	3	85	---	CSS308
Ateca 1.4 TSI	CZEA	06.16 ->	4	110	---	CSS308
Ateca 1.4 TSI 4Drive	CZEA	06.16 ->	4	110	---	CSS308
Cordoba 1.2	AZQ	10.02 - 06.06	3	47	CSS304	CSS300
Cordoba 1.2 12V	BXV	05.06 - 11.09	3	51	CSS304	CSS300
Cordoba 1.4	AKK, ANW, AUD	06.99 - 10.02	4	44	---	CSS300
Cordoba 1.4 16V	APE, AUA	05.00 - 10.02	4	55	---	CSS307
Cordoba 1.4 16V	BBY	09.02 - 12.07	4	55	---	CSS307
Cordoba 1.4 16V	BBZ	10.02 - 11.09	4	74	---	CSS307
Cordoba 1.4 16V	BXW	05.06 - 11.09	4	63	CSS322	CSS307

Typ Type	Motornummer Engine-No.	Baujahr Year	Zyl. Cyl.	KW	Kurbelwellen- sensor Crankshaft S.	Nocken- wellensensor Camshaft S.
Cordoba 1.4 TDI	AMF	10.02 - 12.05	3	55	---	CSS328
Cordoba 1.4 TDI	BMS, BNV	06.05 - 11.09	3	59	---	CSS328
Cordoba 1.4 TDI	BMS, BNV	06.05 - 11.09	3	59	---	CSS329
Cordoba 1.4 TDI	BNM	05.05 - 11.09	3	51	---	CSS328
Cordoba 1.6	AEH, AKL, APF, AUR	06.99 - 10.02	4	74	CSS311	CSS316
Cordoba 1.6	BAH	04.03 - 11.09	4	74	---	CSS300
Cordoba 1.6 16V	BTS	11.06 - 11.09	4	77	CSS322	CSS300
Cordoba 1.8 T 20V Cupra	AQK	07.00 - 10.02	4	115	CSS311	CSS318
Cordoba 1.9 SDI	AGP, AQM	06.99 - 10.02	4	50	CSS315	---
Cordoba 1.9 TDI	AGR, ALH	06.99 - 10.02	4	66	CSS315	---
Cordoba 1.9 TDI	ASK, ASV	06.99 - 10.02	4	81	CSS315	---
Cordoba 1.9 TDI	BMT, AXR, ATD	09.02 - 11.09	4	74	---	CSS329
Cordoba 2.0	AZL, BBX	09.02 - 11.09	4	85	CSS325	CSS316
Cordoba 2.0 i	2E, AGG	02.93 - 06.99	4	85	CSS309	---
Cordoba 2.0 i 16V	ABF	08.96 - 06.99	4	110	CSS309	---
Cordoba Vario 1.6	AKL, APF, AEH, AUR	06.99 - 10.02	4	74	CSS325	---
Exeo 1.6	ALZ	03.09 - 09.10	4	75	CSS333	CSS303
Exeo 1.8 T	CFMA	12.08 - 05.10	4	110	---	CSS303
Exeo 1.8 TSI	CDHA	09.10 ->	4	88	CSS333	---
Exeo 1.8 TSI	CDHA	09.10 ->	4	88	CSS313	---
Exeo 1.8 TSI	CDHB	05.10 ->	4	118	CSS333	---
Exeo 1.8 TSI	CDHB	05.10 ->	4	118	CSS313	---
Exeo 1.8 TSI	CFMA	12.08 - 05.10	4	110	CSS333	---
Exeo 2.0 TDI	CAGA	12.08 ->	4	105	CSS322	---
Exeo 2.0 TDI	CJCA	12.08 ->	4	105	CSS333	---
Exeo 2.0 TDI	CAGC	12.08 ->	4	88	CSS322	---
Exeo 2.0 TDI	CJCC	12.08 ->	4	88	CSS333	---
Exeo 2.0 TDI	CAHA	02.09 ->	4	125	CSS322	---
Exeo 2.0 TDI	CAHA, CGLB	02.09 ->	4	125	CSS333	---
Exeo 2.0 TFSI	BWE	03.09 ->	4	147	CSS333	---
Exeo 2.0 TFSI	BWE	03.09 ->	4	147	CSS325	---
Exeo 2.0 TFSI	CDND	05.10 ->	4	155	CSS333	---
Exeo ST 1.6	ALZ	06.09 - 09.10	4	75	CSS333	---
Exeo ST 1.8 T	CFMA	06.09 - 05.10	4	110	CSS333	---
Exeo ST 1.8 TSI	CDHA	09.10 ->	4	88	CSS333	---
Exeo ST 1.8 TSI	CDHA	09.10 ->	4	88	CSS313	---
Exeo ST 1.8 TSI	CDHB	05.10 ->	4	118	CSS333	---
Exeo ST 1.8 TSI	CDHB	05.10 ->	4	118	CSS313	---
Exeo ST 2.0 TDI	CAGA, CJCA	05.09 ->	4	105	CSS333	---
Exeo ST 2.0 TDI	CAGC, CJCC	07.09 ->	4	88	CSS333	---
Exeo ST 2.0 TDI	CAHA, CGLB	05.09 ->	4	125	CSS333	---
Exeo ST 2.0 TFSI	BWE	06.09 ->	4	147	CSS333	---
Exeo ST 2.0 TFSI	BWE	06.09 ->	4	147	CSS325	---
Exeo ST 2.0 TFSI	CDND	05.10 ->	4	155	CSS333	---
Ibiza II 1.9 SDI	AEY	08.96 - 08.99	4	47	CSS315	---
Ibiza II 2.0 i	2E, AGG	03.93 - 08.99	4	85	CSS309	---
Ibiza II 2.0 i 16V	ABF	08.96 - 08.99	4	110	CSS309	---
Ibiza III 1.0	ALD, ANV, AUC	08.99 - 02.02	4	37	---	CSS300
Ibiza III 1.4	AKK, ANW, AUD	08.99 - 02.02	4	44	---	CSS300
Ibiza III 1.4 16V	APE, AUA	05.00 - 02.02	4	55	---	CSS301
Ibiza III 1.4 16V	APE, AUA	05.00 - 02.02	4	55	---	CSS307
Ibiza III 1.4 16V	AQQ, AUB	08.99 - 02.02	4	74	---	CSS301
Ibiza III 1.4 16V	AQQ, AUB	08.99 - 02.02	4	74	---	CSS307
Ibiza III 1.6	AEH, AKL, APF, AUR	08.99 - 02.02	4	74	CSS311	CSS316
Ibiza III 1.8 T 20 Cupra	AQX, AJP	07.00 - 02.02	4	115	CSS311	CSS318
Ibiza III 1.9 SDI	AGP, AQM	08.99 - 02.02	4	50	CSS315	---
Ibiza III 1.9 TDI	AGR, ALH	08.99 - 02.02	4	66	CSS315	---
Ibiza III 1.9 TDI	ASK, ASV	08.99 - 02.02	4	81	CSS315	---
Ibiza IV	AZL	04.02 - 11.09	4	85	---	CSS316

Typ Type	Motornummer Engine-No.	Baujahr Year	Zyl. Cyl.	KW	Kurbelwellen- sensor Crankshaft S.	Nocken- wellensensor Camshaft S.
Ibiza IV 1.2	AZQ	02.02 - 06.06	3	47	CSS304	---
Ibiza IV 1.2 12V	BXV	05.06 - 11.09	3	51	CSS304	CSS300
Ibiza IV 1.4 16V	BXW	05.06 - 11.09	4	63	CSS322	CSS307
Ibiza IV 1.4 TDI	AMF	05.02 - 12.05	3	55	---	CSS328
Ibiza IV 1.4 TDI	BMS, BNV	06.05 - 11.09	3	59	---	CSS328
Ibiza IV 1.4 TDI	BNM	05.05 - 11.09	3	51	---	CSS328
Ibiza IV 1.4 TDI Cupra R	BPX, BUK	03.04 - 02.08	4	118	---	CSS328
Ibiza IV 1.6 16V	BTS	11.06 - 11.09	4	77	CSS322	CSS300
Ibiza IV 1.8 T Cupra R	BBU, BLZ	01.04 - 02.08	4	132	CSS325	CSS318
Ibiza IV 1.8T FR	BJX, BKV	12.03 - 05.08	4	110	CSS325	CSS318
Ibiza IV 1.9 TDI	BMT, AXR, ATD	02.02 - 11.09	4	74	---	CSS329
Ibiza IV 2.0	AZL, BBX	04.02 - 11.09	4	85	CSS325	---
Ibiza IV Sportcoupe 1.0	CHYB	05.15 ->	3	55	---	CSS308
Ibiza IV Sportcoupe 1.0 TSI	CHZB	05.15 ->	3	70	---	CSS308
Ibiza IV Sportcoupe 1.0 TSI	CHZC	05.15 ->	3	81	---	CSS308
Ibiza IV Sportcoupe 1.2 TSI	CJZC	05.15 ->	4	66	---	CSS308
Ibiza IV Sportcoupe 1.2 TSI	CJZD	09.15 ->	4	81	---	CSS308
Ibiza IV Sportcoupe 1.4 TSI	CPTA	10.13 ->	4	103	---	CSS308
Ibiza IV Sportcoupe 1.4 TSI	CZEA	11.15 ->	4	110	---	CSS308
Ibiza IV Sportcoupe 1.8 TSI Cupra	DAJA	11.15 ->	4	141	---	CSS308
Ibiza IV ST 1.0	CHYB	05.15 ->	3	55	---	CSS308
Ibiza IV ST 1.0 TSI	CHZB	05.15 ->	3	70	---	CSS308
Ibiza IV ST 1.0 TSI	CHZC	05.15 ->	3	81	---	CSS308
Ibiza IV ST 1.2 TSI	CJZC	05.15 ->	4	66	---	CSS308
Ibiza IV ST 1.2 TSI	CJZD	09.15 ->	4	81	---	CSS308
Ibiza IV ST 1.4 TSI	CPTA	10.13 ->	4	103	---	CSS308
Ibiza IV ST 1.4 TSI	CZEA	11.15 ->	4	110	---	CSS308
Ibiza V 1.2	CGPB	07.09 ->	3	44	CSS304	---
Ibiza V 1.2	CJLB, BZG, CGPA	02.08 ->	3	51	CSS304	---
Ibiza V 1.2 TDI	CFWA	04.10 ->	4	55	CSS322	---
Ibiza V 1.2 TSI	CBZB	09.10 ->	4	77	CSS322	CSS300
Ibiza V 1.4	BXW, CGGB	03.08 ->	4	63	CSS322	CSS307
Ibiza V 1.4 TDI	BMS	07.08 - 06.10	3	59	---	CSS329
Ibiza V 1.6	BTS	05.08 ->	4	77	CSS322	CSS300
Ibiza V 1.6 LPG	CNKA	05.11 ->	4	60	---	CSS300
Ibiza V 1.6 TDI	CAYB	05.09 ->	4	66	CSS322	---
Ibiza V 1.6 TDI	CAYC, CLNA	05.09 ->	4	77	CSS322	---
Ibiza V 1.9 TDI	BLS	03.08 - 06.10	4	77	---	CSS329
Ibiza V 1.9 TDI	BXJ	07.08 - 06.10	4	66	---	CSS329
Ibiza V 2.0 TDI	CFHD	01.10 ->	4	105	CSS322	---
Ibiza V Sportcoupe 1.2	CGPB	07.09 ->	3	44	CSS304	---
Ibiza V Sportcoupe 1.2	CJLB, BZG, CGPA	07.08 ->	3	51	CSS304	---
Ibiza V Sportcoupe 1.2 TDI	CFWA	05.10 ->	4	55	CSS322	---
Ibiza V Sportcoupe 1.2 TSI	CBZB	09.10 ->	4	77	CSS322	CSS300
Ibiza V Sportcoupe 1.4	BXW, CGGB	07.08 ->	4	63	CSS322	CSS307
Ibiza V Sportcoupe 1.4 TDI	BMS	07.08 - 06.10	3	59	---	CSS329
Ibiza V Sportcoupe 1.6 LPG	CNKA	05.11 ->	4	60	---	CSS300
Ibiza V Sportcoupe 1.9 TDI	BLS	07.08 - 06.10	4	77	---	CSS329
Ibiza V Sportcoupe 1.9 TDI	BXJ	07.08 - 06.10	4	66	---	CSS329
Ibiza V ST 1.2	CGPB	05.10 ->	3	44	CSS304	---
Ibiza V ST 1.2	CJLB, BZG, CGPA	05.10 ->	3	51	CSS304	---
Ibiza V ST 1.4 TSI	CAVF, CTHF, CNUB, CTJB	02.12 ->	4	110	---	CSS300
Ibiza V ST 1.6	BTS	02.12 ->	4	77	CSS322	---
Ibiza IV 1.4 TDI	BMS, BNV	06.05 - 11.09	3	59	---	CSS329
Inca 1.4 16V	AUA	04.00 - 06.03	4	55	---	CSS307
Inca 1.4 i	AEX, AKV, APQ, AUD	11.95 - 06.03	4	44	CSS707	CSS300
Leon 1,4 TSI	CHPA, CPTA	10.13 ->	4	103	---	CSS308
Leon 1.0 TSI	CHZD	05.15 ->	3	85	---	CSS308
Leon 1.2 TSI	CBZB	02.10 - 12.12	4	77	CSS322	CSS300

Typ Type	Motornummer Engine-No.	Baujahr Year	Zyl. Cyl.	KW	Kurbelwellen- sensor Crankshaft S.	Nocken- wellensensor Camshaft S.
Leon 1.2 TSI	CJZA	01.13 ->	4	77	---	CSS308
Leon 1.2 TSI	CJZB, CYVA	12.12 ->	4	63	---	CSS308
Leon 1.2 TSI	CYVB	04.14 ->	4	81	---	CSS308
Leon 1.4 16V	AHW, APE, AXP, BCA	11.99 - 06.06	4	55	---	CSS300
Leon 1.4 16V	AHW, APE, AXP, BCA	11.99 - 06.06	4	55	---	CSS307
Leon 1.4 16V	BXW, CGGB	06.06 - 12.12	4	63	CSS322	CSS307
Leon 1.4 TGI	CPWA	02.13 ->	4	81	---	CSS308
Leon 1.4 TSI	CAXC	11.07 - 12.12	4	92	CSS322	CSS300
Leon 1.4 TSI	CHPA, CPTA	09.12 ->	4	103	---	CSS308
Leon 1.4 TSI	CMBA, CXSA	11.12 ->	4	90	---	CSS308
Leon 1.4 TSI	CZCA	05.14 ->	4	92	---	CSS308
Leon 1.4 TSI	CZEA	05.14 ->	4	110	---	CSS308
Leon 1.6	AEH, AKL	11.99 - 06.06	4	74	CSS311	CSS316
Leon 1.6	BFQ, BGU	10.05 - 06.06	4	75	---	CSS303
Leon 1.6	BGU, BFQ	10.05 - 06.06	4	75	CSS325	---
Leon 1.6	BSE, BSF, CCSA, CMXA	07.05 - 12.12	4	75	CSS325	CSS303
Leon 1.6 16V	AUS, AZD, BCB	09.00 - 06.06	4	77	---	CSS307
Leon 1.6 LPG	CHGA	12.09 - 12.12	4	75	CSS325	CSS303
Leon 1.6 MultiFuel	CMXA	11.10 - 12.12	4	75	CSS325	CSS303
Leon 1.6 TDI	CAYB	11.10 ->	4	66	CSS322	---
Leon 1.6 TDI	CAYC	02.10 ->	4	77	CSS322	---
Leon 1.6 TDI	CLHA	11.12 ->	4	77	---	CSS331
Leon 1.6 TDI	CLHB	11.12 ->	4	66	---	CSS331
Leon 1.6 TDI	CRKB, CXXB, DBKA	09.13 ->	4	81	---	CSS331
Leon 1.8 20V	AGN, APG	11.99 - 06.06	4	92	CSS311	CSS318
Leon 1.8 20V T	APP, AUQ	11.99 - 06.06	4	132	CSS311	CSS318
Leon 1.8 20V T 4	AJQ, ARY	11.99 - 06.06	4	132	CSS311	CSS318
Leon 1.8 T Cupra R	AMK	02.02 - 06.06	4	154	---	CSS318
Leon 1.8 T Cupra R	BAM	07.03 - 06.06	4	165	---	CSS318
Leon 1.8 TSI	BZB, CDAA	06.07 - 12.12	4	118	CSS313	CSS324
Leon 1.8 TSI	CJSA	02.13 ->	4	132	---	CSS308
Leon 1.9 SDI	AQM	11.99 - 06.06	4	50	CSS315	---
Leon 1.9 TDI	AGR, ALH	11.99 - 06.06	4	66	CSS315	---
Leon 1.9 TDI	AHF, ASV	11.99 - 06.06	4	81	CSS315	---
Leon 1.9 TDI	ARL	09.00 - 06.06	4	110	CSS315	CSS328
Leon 1.9 TDI	ASZ	05.03 - 06.06	4	96	---	CSS328
Leon 1.9 TDI	AXR	10.05 - 06.06	4	74	---	CSS328
Leon 1.9 TDI	BXE, BKC, BLS	07.05 - 12.10	4	77	---	CSS329
Leon 1.9 TDI	BXF	06.07 - 12.10	4	66	---	CSS329
Leon 1.9 TDI Syncro	ARL	05.02 - 06.06	4	110	CSS315	---
Leon 2.0 Cupra	CJXA	10.13 ->	4	206	---	CSS308
Leon 2.0 Cupra	CJXE	10.13 ->	4	195	---	CSS308
Leon 2.0 Cupra	CJXH	10.15 ->	4	213	---	CSS308
Leon 2.0 Cupra R	CDLA	09.09 - 12.12	4	195	CSS325	---
Leon 2.0 FSI	BLR, BLY, BVZ, BVY	07.05 - 05.10	4	110	CSS326	---
Leon 2.0 TDI	AZV	07.05 - 05.10	4	100	---	CSS330
Leon 2.0 TDI	BKD, CFHC, CLCB	07.05 ->	4	103	CSS322	---
Leon 2.0 TDI	BMM	10.05 - 10.10	4	103	---	CSS329
Leon 2.0 TDI	BMN, CEGA, CEJA	05.06 - 12.12	4	125	CSS322	CSS330
Leon 2.0 TDI	CRMB, CKFC	10.12 ->	4	110	---	CSS331
Leon 2.0 TDI	CRVA	05.13 ->	4	81	---	CSS331
Leon 2.0 TDI	CRVC	05.13 ->	4	105	---	CSS331
Leon 2.0 TDI	CUPA, CUNA	09.12 ->	4	135	---	CSS331
Leon 2.0 TDI 16V	CFHC, CLCB, BKD	07.05 - 12.12	4	103	---	CSS330
Leon 2.0 TFSI	BWA	05.05 - 03.09	4	147	CSS325	---
Leon 2.0 TFSI	BWA1	09.05 - 05.06	4	136	CSS325	---
Leon 2.0 TFSI	BWJ, CDLD	11.06 - 05.11	4	177	CSS325	CSS302
Leon 2.0 TFSI	CCZB	06.09 - 12.12	4	155	CSS313	CSS324
Leon 2.8 Cupra 4	AUE	02.01 - 06.06	6	150	---	CSS323

Typ Type	Motornummer Engine-No.	Baujahr Year	Zyl. Cyl.	KW	Kurbelwellen- sensor Crankshaft S.	Nocken- wellensensor Camshaft S.
Leon SC 1.6 TDI	CLHA	02.13 ->	4	77	---	CSS331
Leon SC 1.6 TDI	CLHB	02.13 ->	4	66	---	CSS331
Leon SC 1.6 TDI	CRKB, CXXB, DBKA	09.13 ->	4	81	---	CSS331
Leon SC 2.0 TDI	CRMB, CKFC	02.13 ->	4	110	---	CSS331
Leon SC 2.0 TDI	CRVA	02.13 ->	4	81	---	CSS331
Leon SC 2.0 TDI	CRVC	05.13 ->	4	105	---	CSS331
Leon SC 2.0 TDI	CUPA, CUNA	03.13 ->	4	135	---	CSS331
Leon ST 1.0 TSI	CHZD	05.15 ->	3	85	---	CSS308
Leon ST 1.2 TSI	CJZA	08.13 ->	4	77	---	CSS308
Leon ST 1.2 TSI	CJZB, CYVA	11.13 ->	4	63	---	CSS308
Leon ST 1.2 TSI	CYVB	05.14 ->	4	81	---	CSS308
Leon ST 1.4 TGI	CPWA	10.13 ->	4	81	---	CSS308
Leon ST 1.4 TSI	CMBA, CXSA	10.13 ->	4	90	---	CSS308
Leon ST 1.4 TSI	CZCA	05.14 ->	4	92	---	CSS308
Leon ST 1.4 TSI	CZEA	05.14 ->	4	110	---	CSS308
Leon ST 1.6 TDI	CLHA	10.13 ->	4	77	---	CSS331
Leon ST 1.6 TDI	CLHB	11.13 ->	4	66	---	CSS331
Leon ST 1.6 TDI	CRKB, CXXB, DBKA	09.13 ->	4	81	---	CSS331
Leon ST 1.6 TDI 4Drive	CLHA	04.14 ->	4	77	---	CSS331
Leon ST 1.6 TDI 4Drive	CRKB	11.14 ->	4	81	---	CSS331
Leon ST 1.8 TSI	CJSA	10.13 ->	4	132	---	CSS308
Leon ST 2.0 Cupra	CJXA	10.13 ->	4	206	---	CSS308
Leon ST 2.0 Cupra	CJXE	10.13 ->	4	195	---	CSS308
Leon ST 2.0 Cupra	CJXH	10.15 ->	4	213	---	CSS308
Leon ST 2.0 TDI	CRMB, CKFC, CRLB, CRBC	10.13 ->	4	110	---	CSS331
Leon ST 2.0 TDI	CRVA	11.13 ->	4	81	---	CSS331
Leon ST 2.0 TDI	CRVC	10.13 ->	4	105	---	CSS331
Leon ST 2.0 TDI	CUPA, CUNA	08.13 ->	4	135	---	CSS331
Leon ST 2.0 TDI 4Drive	CRMB, CRLB, CRBC	04.14 ->	4	110	---	CSS331
Leon ST 2.0 TDI 4Drive	CUNA	11.14 ->	4	135	---	CSS331
Mii 1.0	CHYA	10.11 ->	3	44	---	CSS308
Mii 1.0	CHYB	10.11 ->	3	55	---	CSS308
Mii 1.0 EcoFuel	CPGA	11.12 ->	3	50	---	CSS308
Toledo I 2.0 i	2E, AGG	05.91 - 03.99	4	85	CSS309	---
Toledo I 2.0 i	ABF	11.93 - 03.99	4	110	CSS309	---
Toledo II 1.4 16V	AHW, AXP	07.99 - 05.06	4	55	---	CSS307
Toledo II 1.6	AEH, AKL	04.99 - 09.00	4	74	CSS311	CSS316
Toledo II 1.8 20VT	APP, AUQ	05.01 - 05.06	4	132	CSS325	---
Toledo II 1.9 TDI	ARL	10.00 - 05.06	4	110	---	CSS328
Toledo II 1.9 TDI	ASZ	05.03 - 05.06	4	96	---	CSS328
Toledo II 2.3 V5	AGZ	10.98 - 11.00	5	110	---	CSS323
Toledo II 2.3 V5 20V	AQN	09.00 - 11.03	5	125	---	CSS323
Toledo III 1.6	BGU, BSE, BSF, CCSA	10.04 - 05.09	4	75	CSS325	CSS303
Toledo III 1.8 TFSI	BYT, BZB, CDAA	01.07 - 05.09	4	118	CSS313	---
Toledo III 1.8 TFSI	BYT, BZB, CDAA	01.07 - 05.09	4	118	---	CSS324
Toledo III 1.9 TDI	BXE, BKC, BJB, BLS	10.04 - 05.09	4	77	---	CSS329
Toledo III 2.0 FSI	BLR, BLY, BVZ, BYY	10.04 - 05.09	4	110	CSS326	CSS302
Toledo III 2.0 TDI	AZV	09.04 - 05.09	4	100	---	CSS330
Toledo III 2.0 TDI	BMM	11.05 - 05.09	4	103	---	CSS329
Toledo III 2.0 TDI	BMN, CEGA	01.06 - 05.09	4	125	CSS322	CSS330
Toledo III 2.0 TDI 16V	BKD	04.04 - 05.09	4	103	---	CSS330
Toledo III 2.0 TFSI	BWA	11.05 - 05.09	4	147	---	CSS302
Toledo IV 1.2	CGPC	07.12 ->	3	55	CSS304	CSS300
Toledo IV 1.2 TSI	CBZA	07.12 ->	4	63	---	CSS300
Toledo IV 1.2 TSI	CBZB	07.12 ->	4	77	---	CSS300
Toledo IV 1.2 TSI	CJZC	05.15 ->	4	66	---	CSS308
Toledo IV 1.2 TSI	CJZD	05.15 ->	4	81	---	CSS308
Toledo IV 1.4 TSI	CAXA	07.12 ->	4	90	---	CSS300
Toledo IV 1.4 TSI	CZCA	05.15 ->	4	92	---	CSS308

Typ Type	Motornummer Engine-No.	Baujahr Year	Zyl. Cyl.	KW	Kurbelwellen- sensor Crankshaft S.	Nocken- wellensensor Camshaft S.
Toledo IV 1.6	CFNA	07.13 ->	4	77	CSS322	---
Toledo IV 1.6 TDI	CAYB	06.13 ->	4	66	CSS322	---
Toledo IV 1.6 TDI	CXMA	05.15 ->	4	85	---	CSS331
<b>Skoda</b>						
Citigo 1.0	CHYA	10.11 ->	3	44	---	CSS308
Citigo 1.0	CHYB	10.11 ->	3	55	---	CSS308
Citigo 1.0 CNG	CPGA	11.12 ->	3	50	---	CSS308
Fabia I 1.4 16V	AUA, BBY, BKY	12.99 - 03.08	4	55	CSS322	CSS307
Fabia I 1.4 16V	AUA, BBY, BKY	10.99 - 12.07	4	55	CSS322	CSS307
Fabia I 1.4 16V	AUA, BBY, BKY	12.99 - 03.08	4	55	---	CSS307
Fabia I 1.4 16V	BUD	04.06 - 12.07	4	59	CSS322	CSS307
Fabia I 1.4 TDI	AMF	04.03 - 03.08	3	55	---	CSS328
Fabia I 1.4 TDI	BNM	10.05 - 03.08	3	51	---	CSS328
Fabia I 1.4 TDI	BNV	10.05 - 03.08	3	59	---	CSS328
Fabia I 2.0	AQY, AZL	12.99 - 12.07	4	85	CSS311	CSS316
Fabia II 1.2	AWY, BMD	08.02 - 03.08	4	40	CSS304	CSS300
Fabia II 1.2	AZQ, BME	01.03 - 03.08	4	47	CSS304	---
Fabia II 1.2	BBM, CHFA	12.06 - 12.14	3	44	CSS304	CSS300
Fabia II 1.2 12V	CGPB	11.11 - 12.14	3	44	CSS304	---
Fabia II 1.2 TDI	CFWA	05.10 ->	4	55	CSS322	---
Fabia II 1.2 TSI	CBZA	03.10 - 12.14	4	63	CSS322	CSS300
Fabia II 1.2 TSI	CBZB	03.10 - 12.14	4	77	CSS322	CSS300
Fabia II 1.4	BXW, CGGB	01.07 - 12.14	4	63	CSS322	CSS307
Fabia II 1.4 TDI	BMS, BNV	01.07 - 03.10	3	59	---	CSS329
Fabia II 1.4 TSI	CAVE	05.10 - 12.14	4	132	CSS322	CSS300
Fabia II 1.6	BTS, CFNA	04.07 - 12.14	4	77	CSS322	CSS300
Fabia II 1.6 TDI	CAYA	04.10 - 12.14	4	55	CSS322	---
Fabia II 1.6 TDI	CAYB	03.10 - 12.14	4	66	CSS322	---
Fabia II 1.6 TDI	CAYC	03.10 - 12.14	4	77	CSS322	---
Fabia II 1.9 TDI	BSW, BLS	04.07 - 03.10	4	77	---	CSS329
Fabia III 1.0	CHYA	08.14 ->	3	44	---	CSS308
Fabia III 1.0	CHYB	08.14 ->	3	55	---	CSS308
Fabia III 1.2 TSI	CJZC	08.14 ->	4	66	---	CSS308
Fabia III 1.2 TSI	CJZD	08.14 ->	4	81	---	CSS308
Fabia III 1.6	CWVA	01.15 ->	4	81	---	CSS308
Fabia Praktik 1.4 TDI	BNM	10.05 - 12.07	3	51	---	CSS328
Kodiaq 1.4 TSI 4x4	CZEA	10.16 ->	4	110	---	CSS308
Kodiaq 2.0 TSI 4x4	CZPA	10.16 ->	4	132	---	CSS308
Octavia 1.9 TDI	ASZ	09.02 - 09.04	4	96	---	CSS328
Octavia 1.9 TDI	AXR	10.05 - 12.10	4	74	---	CSS328
Octavia 1.2 TSI	CBZB	02.10 - 06.13	4	77	CSS322	CSS300
Octavia 1.4	BUD, CGGA	06.04 - 04.13	4	59	CSS322	CSS307
Octavia 1.4 16V	AXP, BCA	09.00 - 12.10	4	55	---	CSS307
Octavia 1.4 TSI	CAXA	11.08 - 06.13	4	90	CSS322	CSS300
Octavia 1.6	AEH, AKL	02.97 - 12.07	4	74	CSS311	CSS316
Octavia 1.6	AVU, BFQ	11.00 - 12.10	4	75	---	CSS303
Octavia 1.6	AVU, BFQ	11.00 - 12.10	4	75	CSS325	---
Octavia 1.6	BGU, CCSA, BSF, CMXA, BSE	06.04 - 06.13	4	75	CSS325	CSS303
Octavia 1.6 LPG	CHGA	08.09 - 11.12	4	75	CSS325	CSS303
Octavia 1.6 MultiFuel	CCSA, CMXA	01.08 - 06.13	4	75	CSS325	---
Octavia 1.6 MultiFuel	CHGA	01.08 - 06.13	4	75	---	CSS303
Octavia 1.6 TDI	CAYC	06.09 ->	4	77	CSS322	---
Octavia 1.8	AGN	09.96 - 07.00	4	92	CSS311	CSS318
Octavia 1.8 T	AGU, ARX, ARZ, AUM	08.97 - 12.10	4	110	CSS311	CSS318
Octavia 1.8 TFSI	BZB, CDAA	06.07 - 04.13	4	118	---	CSS324
Octavia 1.8 TSI	BZB	06.07 - 04.13	4	118	---	CSS320
Octavia 1.8 TSI	BZB, CDAA	06.07 - 04.13	4	118	---	CSS302
Octavia 1.9 TDI	BJB, BKC	06.04 - 12.10	4	77	---	CSS302

Typ Type	Motornummer Engine-No.	Baujahr Year	Zyl. Cyl.	KW	Kurbelwellen- sensor Crankshaft S.	Nocken- wellensensor Camshaft S.
Octavia 1.9 TDI	BXE, BKC, BJB, BLS	06.04 - 12.10	4	77	---	CSS329
Octavia 1.9 TDI 4x4	BXE, BKC, BLS	11.04 - 12.10	4	77	---	CSS329
Octavia 2.0	AEG, APK, AQY, AZH	04.99 - 05.07	4	85	CSS311	CSS316
Octavia 2.0 FSI	BLY, BLR, BVZ, BVI	11.04 - 10.08	4	110	CSS326	CSS302
Octavia 2.0 RS	BWA, CCZA	10.05 - 02.13	4	147	CSS325	CSS324
Octavia 2.0 RS	CEGA, BMN	04.06 - 02.13	4	125	---	CSS330
Octavia 2.0 TDI	AZV	02.04 - 05.10	4	100	---	CSS330
Octavia 2.0 TDI	BMM	11.05 - 05.10	4	103	---	CSS329
Octavia 2.0 TDI	CFHF, CLCA	03.10 ->	4	81	CSS322	---
Octavia 2.0 TDI 16V	BKD	02.04 - 04.13	4	103	---	CSS302
Octavia 2.0 TDI 16V	BKD, CFHC, CLCB	02.04 - 04.13	4	103	CSS322	CSS330
Octavia 2.0 TDI 4x4	BMM	07.06 - 05.10	4	103	---	CSS329
Octavia II 1.8 TSI	BZB, CDA	06.07 - 04.13	4	118	CSS313	---
Octavia II 1.8 TSI	CDAB	03.09 - 06.13	4	112	CSS313	---
Octavia II 2.0 RS	BWA, CCZA	10.05 - 02.13	4	147	CSS313	---
Octavia III 1.2 TSI	CJZA	11.12 ->	4	77	---	CSS308
Octavia III 1.2 TSI	CJZB	11.12 ->	4	63	---	CSS308
Octavia III 1.2 TSI	CYVB	05.15 ->	4	81	---	CSS308
Octavia III 1.4 TSI	CHPA	11.12 ->	4	103	---	CSS308
Octavia III 1.4 TSI	CHPB, CZDA	08.14 ->	4	110	---	CSS308
Octavia III 1.4 TSI G-TEC	CPWA	11.13 ->	4	81	---	CSS308
Octavia III 1.6	CWVA	01.14 ->	4	81	---	CSS308
Octavia III 1.6 TDI	CLHA	11.12 ->	4	77	---	CSS331
Octavia III 1.6 TDI	CLHB, DDYB	11.12 ->	4	66	---	CSS331
Octavia III 1.6 TDI 4x4	CLHA	09.14 ->	4	77	---	CSS331
Octavia III 1.8 TSI	CJSA	11.12 ->	4	132	---	CSS308
Octavia III 2.0 TDI	CRMB, CKFC	11.12 ->	4	110	---	CSS331
Octavia III 2.0 TDI	CRVC, CKFB	11.12 ->	4	105	---	CSS331
Octavia III 2.0 TDI 4x4	CKFC	09.14 ->	4	110	---	CSS331
Octavia III 2.0 TDI RS	CUPA, CUNA	05.13 ->	4	135	---	CSS331
Octavia III 2.0 TDI/TDI RS 4x4	CUPA, CUNA	09.14 ->	4	135	---	CSS331
Octavia III 2.0 TSI RS	CHHA	05.15 ->	4	169	---	CSS308
Octavia III 2.0 TSI RS	CHHB	05.13 ->	4	162	---	CSS308
Octavia RS 1.8 T	AUQ	05.01 - 01.06	4	132	---	CSS318
Octavia RS 1.8 T	AUQ	05.01 - 01.06	4	132	CSS325	---
Rapid 1.2	CGPC	07.12 ->	3	55	CSS304	CSS300
Rapid 1.2 TSI	CBZA	07.12 ->	4	63	---	CSS300
Rapid 1.2 TSI	CJZC	05.15 ->	4	66	---	CSS308
Rapid 1.2 TSI	CJZD	05.15 ->	4	81	---	CSS308
Rapid 1.4 TSI	CAXA	07.12 ->	4	90	---	CSS300
Rapid 1.4 TSI	CZCA	05.15 ->	4	92	---	CSS308
Rapid 1.6 TDI	CAYB	08.13 ->	4	66	CSS322	---
Rapid 1.6 TDI	CXMA	05.15 ->	4	85	---	CSS331
Rapid Spaceback 1.2 TSI	CJZC	05.15 ->	4	66	---	CSS308
Rapid Spaceback 1.2 TSI	CJZD	05.15 ->	4	81	---	CSS308
Rapid Spaceback 1.4 TSI	CZCA	05.15 ->	4	92	---	CSS308
Rapid Spaceback 1.6 TDI	CAYB	08.13 ->	4	66	CSS322	---
Rapid Spaceback 1.6 TDI	CXMA	05.15 ->	4	85	---	CSS331
Roomster 1.2 TDI	CFWA	03.10 ->	4	55	CSS322	---
Roomster 1.2 TSI	CBZA	03.10 - 05.15	4	63	CSS322	CSS300
Roomster 1.2 TSI	CBZB	03.10 - 05.15	4	77	CSS322	CSS300
Roomster 1.4	BXW, CGGB	09.06 - 05.15	4	63	CSS322	CSS307
Roomster 1.4 TDI	BMS, BNV	09.06 - 03.10	3	59	---	CSS329
Roomster 1.4 TDI	BNM	07.06 - 03.10	3	51	---	CSS328
Roomster 1.6	BTS, CFNA	09.06 - 05.15	4	77	CSS322	CSS307
Roomster 1.6 TDI	CAYB	03.10 ->	4	66	CSS322	---
Roomster 1.6 TDI	CAYC	03.10 - 05.15	4	77	CSS322	---
Roomster 1.9 TDI	BSW, BLS	09.06 - 03.10	4	77	---	CSS329
Roomster Praktik 1.2 TDI	CFWA	03.10 ->	4	55	CSS322	---

Typ Type	Motornummer Engine-No.	Baujahr Year	Zyl. Cyl.	KW	Kurbelwellen- sensor Crankshaft S.	Nocken- wellensensor Camshaft S.
Roomster Praktik 1.2 TSI	CBZA	03.10 - 05.15	4	63	CSS322	CSS300
Roomster Praktik 1.4	BXW, CGGB	03.07 - 05.15	4	63	CSS322	CSS307
Roomster Praktik 1.4 TDI	BNM	03.07 - 03.10	3	51	---	CSS328
Roomster Praktik 1.6 TDI	CAYB	03.10 ->	4	66	CSS322	---
Superb 1.4 TSI	CAXC	07.08 - 05.15	4	92	CSS322	CSS300
Superb 1.6 TDI	CAYC	09.10 ->	4	77	CSS322	---
Superb 1.8 T	AWT	02.02 - 03.08	4	110	---	CSS318
Superb 1.8 TSI	BZB, CDAA	03.08 - 05.15	4	118	---	CSS324
Superb 1.8 TSI	BZB, CDAA	03.08 - 05.15	4	118	---	CSS320
Superb 1.8 TSI	CDAB	03.09 - 05.15	4	112	---	CSS324
Superb 1.9 TDI	BXE, BLS	03.08 - 11.10	4	77	---	CSS329
Superb 2.0	AZM	02.02 - 03.08	4	85	CSS311	CSS316
Superb 2.0 TDI	BMP	03.08 - 05.10	4	103	---	CSS329
Superb 2.0 TDI	CBBB, CFGB	07.08 ->	4	125	CSS322	---
Superb 2.0 TDI 16V	BKD, CFFB, CLJA	01.09 - 05.15	4	103	CSS322	CSS330
Superb 2.8 V6	AMX	02.02 - 03.08	6	142	CSS311	CSS318
Superb II 1.8 TSI	BZB, CDAA	03.08 - 05.15	4	118	CSS313	---
Superb II 1.8 TSI	CDAB	03.09 - 05.15	4	112	CSS313	---
Superb II 1.8 TSI 4x4	CDAA	11.08 - 05.15	4	118	CSS313	---
Superb II 1.8 TSI 4x4	CDAB	03.09 - 05.15	4	112	CSS313	---
Superb II 2.0 TSI	CCZA	05.10 - 05.15	4	147	CSS313	---
Superb II 2.0 TSI	CCZA	05.10 - 05.15	4	147	CSS313	---
Superb II Estate 1.8 TSI	CDAA	10.09 - 05.15	4	118	CSS313	---
Superb II Estate 1.8 TSI	CDAB	10.09 - 05.15	4	112	CSS313	---
Superb II Estate 1.8 TSI 4x4	CDAA	10.09 - 05.15	4	118	CSS313	---
Superb II Estate 1.8 TSI 4x4	CDAB	10.09 - 05.15	4	112	CSS313	---
Superb III 1.4 TSI	CZCA	03.15 ->	4	92	---	CSS308
Superb III 1.4 TSI	CZDA, CZEA	03.15 ->	4	110	---	CSS308
Superb III 1.4 TSI 4x4	CZEA	03.15 ->	4	110	---	CSS308
Superb III 1.6 TDI	DCXA, DCZA	03.15 ->	4	88	---	CSS331
Superb III 1.8 TSI	CJSA, CJSC	03.15 ->	4	132	---	CSS308
Superb III 2.0 TDI	CRLB, DFEA	03.15 ->	4	110	---	CSS331
Superb III 2.0 TDI	DFCA, DDAA	03.15 ->	4	140	---	CSS331
Superb III 2.0 TDI 4x4	DFCA, DDAA	03.15 ->	4	140	---	CSS331
Superb III 2.0 TSI	CHHB	03.15 ->	4	162	---	CSS308
Superb III 2.0 TSI 4x4	CJXA	03.15 ->	4	206	---	CSS308
Yeti 1.2 TSI	CBZB	09.09 ->	4	77	CSS322	CSS300
Yeti 1.2 TSI	CYVB	05.15 ->	4	81	---	CSS308
Yeti 1.4 TSI	CAXA	06.10 ->	4	90	CSS322	CSS300
Yeti 1.6	CWVA	04.14 ->	4	81	---	CSS308
Yeti 1.6 TDI	CAYC	11.10 ->	4	77	CSS322	---
Yeti 1.8 TSI 4x4	CDAA	05.09 ->	4	118	CSS313	CSS324
Yeti 1.8 TSI 4x4	CDAB	11.09 ->	4	112	CSS313	CSS324
Yeti 2.0 TDI	CFHA, CLCA	11.09 ->	4	81	CSS322	---
Yeti 2.0 TDI	CFHC	11.11 ->	4	103	CSS322	---
<b>Suzuki</b>						
Ignis II 1.3 DDiS	Z 13 DT	09.03 ->	4	51	---	CSS716
Wagon R+ 1.3 DDiS	Z 13 DT	09.03 ->	4	51	---	CSS716
Swift III 1.3 DDiS	Z 13 DT	08.05 ->	4	51	---	CSS716
Swift IV 1.3 DDiS	D13A	10.10 ->	4	55	---	CSS716
<b>Toyota</b>						
Auris 1.4 D-4D	1ND-TV	03.07 - 09.12	4	66	---	CSS914
Aygo 1.4 HDI	2WZ-TV	07.05 - 08.10	4	40	CSS1517	CSS1519
Aygo 1.4 HDI	2WZ-TV	07.05 - 08.10	4	40	CSS1538	CSS1519
Corolla 1.4 D	1ND-TV	07.04 - 02.07	4	66	---	CSS914
Yaris 1.4 D-4D	1ND-TV	12.01 - 09.05	4	55	---	CSS914
Yaris 1.4 D-4D	1ND-TV	08.05 ->	4	66	---	CSS914

Typ Type	Motornummer Engine-No.	Baujahr Year	Zyl. Cyl.	KW	Kurbelwellen- sensor Crankshaft S.	Nocken- wellensensor Camshaft S.
Yaris Verso 1.4 D-4D	1ND-TV	12.01 - 09.05	4	55	---	CSS914
<b>Volkswagen</b>						
Amarok 2.0 TSI	CFPA	12.10 ->	4	118	CSS313	---
Beetle 1.2 TSI 16V	CYVD	12.14 ->	4	77	---	CSS308
Beetle 1.4 TSI	CZDA	12.14 ->	4	110	---	CSS308
Beetle 2.0 TSI	CBFA, CCTA, CCZA	04.11 ->	4	147	CSS313	---
Beetle 2.0 TSI	CPLA, CPPA	12.12 ->	4	155	---	CSS308
Beetle 2.0 TSI	CULC	12.14 ->	4	162	---	CSS308
Beetle Cabriolet 1.2 TSI 16V	CYVD	12.14 ->	4	77	---	CSS308
Beetle Cabriolet 1.4 TSI	CZDA	12.14 ->	4	110	---	CSS308
Beetle Cabriolet 1.8 TSI	CPKA, CPRA	12.13 ->	4	125	---	CSS308
Beetle Cabriolet 2.0 TDI	CUUA	06.14 ->	4	81	---	CSS331
Beetle Cabriolet 2.0 TDI	CUUB, CVCA, DELA	09.14 ->	4	110	---	CSS331
Beetle Cabriolet 2.0 TSI	CBFA, CCTA, CCZA	12.11 ->	4	147	CSS313	---
Beetle Cabriolet 2.0 TSI	CPLA, CPPA	12.12 ->	4	155	---	CSS308
Beetle Cabriolet 2.0 TSI	CULC	12.14 ->	4	162	---	CSS308
Bora 1.4 16V	AHW, AKQ, APE, AXP, BCA	03.00 - 05.05	4	55	---	CSS307
Bora 1.6	AEH, AKL, APF	10.98 - 05.05	4	74	CSS311	CSS316
Bora 1.6	AVU, BFQ, BJH	08.00 - 05.05	4	75	CSS325	CSS303
Bora 1.6	BFQ	08.00 - 05.05	4	75	---	CSS316
Bora 1.6 16V	ATN, AUS, AZD, BCB	05.00 - 05.05	4	77	---	CSS307
Bora 1.6 FSI	BAD	01.02 - 05.05	4	81	---	CSS300
Bora 1.8 4motion	AGN	02.99 - 05.05	4	92	CSS311	---
Bora 1.8 T	ARX, BAE, AGU, AUM	05.00 - 05.05	4	110	CSS325	---
Bora 1.8 T	AUQ	03.02 - 05.05	4	132	CSS325	---
Bora 1.9 TDI	AJM, AUY	12.98 - 01.02	4	85	---	CSS328
Bora 1.9 TDI	ARL	05.00 - 05.05	4	110	---	CSS328
Bora 1.9 TDI	ASZ	11.00 - 05.05	4	96	---	CSS328
Bora 1.9 TDI	AXR, ATD	09.00 - 05.05	4	74	---	CSS328
Bora 1.9 TDI 4motion	AJM, AUY	02.99 - 06.01	4	85	---	CSS328
Bora 1.9 TDI 4motion	ARL	05.00 - 05.05	4	110	---	CSS328
Bora 1.9 TDI 4motion	ASZ	11.00 - 05.05	4	96	---	CSS328
Bora 1.9 TDI 4motion	ATD	09.00 - 05.05	4	74	---	CSS328
Bora 2.0	APK, AQY, AZG, AZH, AZJ	10.98 - 05.05	4	85	CSS311	CSS316
Bora 2.0 4motion	AZH, AZJ	04.00 - 05.05	4	85	CSS311	---
Bora 2.3 V5	AGZ (10.98-)	10.98 - 10.00	5	110	---	CSS323
Bora 2.3 V5	AQN	10.00 - 05.05	5	125	---	CSS323
Bora 2.3 V5 4motion	AGZ (12.98-)	12.98 - 10.00	5	110	---	CSS323
Bora 2.3 V5 4motion	AQN	10.00 - 05.05	5	125	---	CSS323
Bora 2.8 V6 4motion	AQP (05.99-05.00), AUE, BDE	03.99 - 05.05	6	150	---	CSS323
Bora 2.8 V6 4motion	AQP, AUE, BDE	03.99 - 05.05	6	150	---	CSS316
Caddy II 1.4	AEX, AKV, APQ, AUD	11.95 - 01.04	4	44	---	CSS300
Caddy II 1.4 16V	AUA	08.00 - 01.04	4	55	---	CSS307
Caddy II 60 1.4	AEX, APQ, AUD	11.95 - 01.04	4	44	---	CSS300
Caddy III 1.2 TSI	CBZA	09.10 ->	4	63	CSS322	CSS300
Caddy III 1.2 TSI	CBZB	09.10 ->	4	77	CSS322	CSS300
Caddy III 1.4 16V	BUD	05.06 - 08.10	4	59	CSS322	CSS307
Caddy III 1.6	BGU, BSF, BSE	04.04 ->	4	75	CSS325	CSS303
Caddy III 1.6 BiFuel	CHGA	05.11 ->	4	75	CSS325	CSS303
Caddy III 1.9 TDI	BJB, BLS	04.04 - 08.10	4	77	---	CSS329
Caddy III 1.9 TDI	BSU	09.05 - 08.10	4	55	---	CSS329
Caddy III 1.9 TDI 4motion	BLS	05.08 - 08.10	4	77	---	CSS329
Caddy III 2.0 Eco Fuel	BSX	04.06 ->	4	80	CSS325	CSS316
Caddy III 2.0 SDI	BST, BDJ	03.04 - 08.10	4	51	---	CSS329
Caddy III 2.0 TDI	BMM	09.07 - 08.10	4	103	---	CSS329
Caddy III 2.0 TDI	CFHC	11.10 ->	4	103	CSS322	---
Caddy III 2.0 TDI	CFJA	05.12 ->	4	125	CSS322	---
Caddy III 2.0 TDI 4motion	CFHC	10.10 ->	4	81	CSS322	---

Typ Type	Motornummer Engine-No.	Baujahr Year	Zyl. Cyl.	KW	Kurbelwellen- sensor Crankshaft S.	Nocken- wellensensor Camshaft S.
Caddy IV 1.6 TDI	CAYD	05.15 ->	4	75	CSS322	---
Caddy IV 1.6 TDI	CAYE	05.15 ->	4	55	CSS322	---
Caddy IV 2.0 TDI	CFHC, CLCB	05.15 ->	4	103	CSS322	---
Caddy IV 2.0 TDI	CUUB, DFSB	05.15 ->	4	110	---	CSS331
Caddy IV 2.0 TDI	CUUD, DFSD	05.15 ->	4	75	---	CSS331
Caddy IV 2.0 TDI	CUUF, DFSF	05.15 ->	4	55	---	CSS331
Caddy IV 2.0 TDI 4motion	CFHC	05.15 ->	4	103	CSS322	---
Caddy IV 2.0 TDI 4motion	CFHF	05.15 ->	4	81	CSS322	---
Caddy IV 2.0 TDI 4motion	DFSE, CUUE	05.15 ->	4	90	---	CSS331
Caddy IV Box 1.0 TSI	CHZG	11.15 ->	3	75	---	CSS308
Caddy IV Box 1.2 TSI	CYVC	06.15 ->	4	62	---	CSS308
Caddy IV Box 1.4 TGI CNG	CPWA	06.15 ->	4	81	---	CSS308
Caddy IV Box 1.4 TSI	CZCB	05.15 ->	4	92	---	CSS308
Caddy IV Variant 1.0 TSI	CHZG	11.15 ->	3	75	---	CSS308
Caddy IV Variant 1.2 TSI	CYVC	06.15 ->	4	62	---	CSS308
Caddy IV Variant 1.4 TGI CNG	CPWA	06.15 ->	4	81	---	CSS308
Caddy IV Variant 1.4 TSI	CZCB	05.15 ->	4	92	---	CSS308
CC 1.4 TSI	CZDA	05.15 - 12.16	4	110	---	CSS308
CC 1.8 TSI	CDA A	11.11 - 12.16	4	118	CSS313	---
CC 2.0 TDI	CUVC	05.15 ->	4	110	---	CSS331
CC 2.0 TDI	CUWA	05.15 ->	4	135	---	CSS331
Corrado 2.9 VR6	ABV	08.91 - 12.95	6	140	CSS309	---
Crafter 30-35 2.0 TDI	CSLB	11.13 ->	4	84	CSS322	---
Crafter 30-35 2.5 TDI	BJJ, CEBA	04.06 - 07.11	5	65	CSS322	CSS329
Crafter 30-35 2.5 TDI	BJK, CEBB	04.06 ->	5	80	CSS322	CSS329
Crafter 30-35 2.5 TDI	BJL, CECA	04.06 ->	5	100	CSS322	CSS329
Crafter 30-35 2.5 TDI	BJM, CECB	04.06 - 07.11	5	120	CSS322	CSS329
Eos 1.4 TSI	CAVD	05.08 ->	4	118	CSS322	CSS300
Eos 1.4 TSI	CAXA	11.07 ->	4	90	CSS322	CSS300
Eos 2.0 FSI	BVZ, BVY	03.06 - 05.08	4	110	CSS326	CSS302
Eos 2.0 TDI	BMM	06.06 - 05.08	4	103	---	CSS329
Eos 2.0 TDI	CFFA	05.08 ->	4	100	CSS322	---
Eos 2.0 TDI 16V	CBAB, CFFB	05.08 ->	4	103	CSS322	---
Eos 2.0 TFSI	BPY, CBFA, CCZA, CAWB, CCTA	03.06 ->	4	147	CSS325	CSS302
Eos 2.0 TFSI	BWA, CAWB, CCZA	03.06 ->	4	147	---	CSS302
Eos 2.0 TSI	CCZB	09.11 - 08.15	4	155	CSS313	CSS324
Eos 3.2 V6	BUB, CBRA	06.06 - 05.09	6	184	---	CSS323
Fox 1.2	BMD	04.05 ->	3	40	CSS304	---
Fox 1.2	CHFA	09.10 ->	3	44	CSS304	---
Fox 1.4	BKR	04.05 ->	4	55	CSS322	CSS300
Fox 1.4 TDI	BNM	04.05 ->	3	51	---	CSS328
Golf Alltrack 1.6 TDI 4motion	CRKB, CXXB	12.14 ->	4	81	---	CSS331
Golf Alltrack 2.0 TDI 4motion	CUNA, DGCA	12.14 ->	4	135	---	CSS331
Golf Alltrack 2.0 TDI 4motion	DCYA, CRLB, CRBC	12.14 ->	4	110	---	CSS331
Golf III 1.6	AEK, AFT, AKS	07.95 - 08.97	4	74	CSS319	---
Golf III 2.0	2E, ADY, AGG, AKR	11.91 - 08.97	4	85	CSS309	---
Golf III 2.0 GTI 16V	ABF	08.92 - 08.97	4	110	CSS309	---
Golf III 2.0 Syncro	AGG	08.95 - 08.97	4	85	CSS309	---
Golf IV 1.4 16V	AHW, AKQ, APE, AXP, BCA	08.97 - 06.05	4	55	---	CSS307
Golf IV 1.6	AEH, AKL, APF	08.97 - 02.00	4	74	CSS311	CSS316
Golf IV 1.6	AVU, BFQ, BJH	08.00 - 06.05	4	75	CSS325	CSS316
Golf IV 1.6 16V	ATN, AUS, AZD, BCB	02.00 - 06.05	4	77	---	CSS307
Golf IV 1.6 FSI	BAD	01.02 - 06.05	4	81	---	CSS300
Golf IV 1.8	AGN, BAF	08.97 - 06.05	4	92	CSS311	---
Golf IV 1.8 4motion	AGN	05.98 - 06.05	4	92	CSS311	---
Golf IV 1.8 T	AGU, ARZ, AUM	08.97 - 06.05	4	110	CSS311	---
Golf IV 1.8 T	ARZ, AQA, AGU, AUM, AWD	08.97 - 06.05	4	110	CSS325	---
Golf IV 1.8 T GTI	AUQ	08.01 - 06.05	4	132	CSS325	---
Golf IV 1.9 TDI	AGR, ALH	10.97 - 05.04	4	66	CSS315	---

Typ Type	Motornummer Engine-No.	Baujahr Year	Zyl. Cyl.	KW	Kurbelwellen- sensor Crankshaft S.	Nocken- wellensensor Camshaft S.
Golf IV 1.9 TDI	ARL	05.00 - 06.05	4	110	---	CSS328
Golf IV 1.9 TDI	ASZ	11.00 - 06.05	4	96	---	CSS328
Golf IV 1.9 TDI	AXR, ATD	09.00 - 06.05	4	74	---	CSS328
Golf IV 1.9 TDI 4motion	AJM, AUY	09.99 - 06.01	4	85	---	CSS328
Golf IV 1.9 TDI 4motion	ARL	02.00 - 06.05	4	110	---	CSS328
Golf IV 1.9 TDI 4motion	ASZ	11.00 - 06.05	4	96	---	CSS328
Golf IV 1.9 TDI 4motion	ATD	09.00 - 06.05	4	74	---	CSS328
Golf IV 2.0	APK, AQY, AZG, AZJ	07.98 - 06.05	4	85	CSS311	CSS316
Golf IV 2.0 4motion	AZH, AZY	10.00 - 06.05	4	85	CSS311	CSS316
Golf IV 2.3 V5	AGZ (08.97-.)	08.97 - 10.00	5	110	---	CSS323
Golf IV 2.3 V5	AQN	10.00 - 06.05	5	125	---	CSS323
Golf IV 2.3 V5 4motion	AGZ (12.98-.)	12.98 - 10.00	5	110	---	CSS323
Golf IV 2.3 V5 4motion	AQN	10.00 - 06.05	5	125	---	CSS323
Golf IV 2.8 V6 4motion	AQP, AUE, BDE	03.99 - 06.05	6	150	---	CSS323
Golf IV 3.2 R32 4motion	BFH, BML	09.02 - 06.05	6	177	---	CSS323
Golf IV Variant 1.9 TDI	ASZ	11.00 - 06.06	4	96	---	CSS328
Golf IV Variant 1.9 TDI	AXR, ATD	09.00 - 06.06	4	74	---	CSS328
Golf IV Variant 1.9 TDI 4motion	AJM	05.99 - 06.01	4	85	---	CSS328
Golf IV Variant 1.9 TDI 4motion	ASZ	11.00 - 06.06	4	96	---	CSS328
Golf IV Variant 1.9 TDI 4motion	ATD	09.00 - 06.06	4	74	---	CSS328
Golf IV Variant 2.3 V5	AQN (10.00-.)	10.00 - 06.06	5	125	---	CSS323
Golf IV Variant 2.3 V5 4motion	AGZ (05.99-.)	05.99 - 06.06	5	110	---	CSS323
Golf IV Variant 2.3 V5 4motion	AQN (10.00-.)	10.00 - 06.06	5	125	---	CSS323
Golf IV Variant 2.8 V6 4motion	AQP, AUE, BDE	05.99 - 06.06	6	150	---	CSS323
Golf V 1.4 16V	BCA	10.03 - 05.06	4	55	---	CSS307
Golf V 1.4 16V	BUD	05.06 - 11.08	4	59	CSS322	CSS307
Golf V 1.4 FSI	BKG, BLN	10.03 - 07.06	4	66	---	CSS300
Golf V 1.4 TSI	BLG	11.05 - 11.08	4	125	CSS322	CSS300
Golf V 1.4 TSI	BMV	05.06 - 11.08	4	103	CSS322	CSS300
Golf V 1.4 TSI	CAXA	05.07 - 11.08	4	90	CSS322	CSS300
Golf V 1.6	BGU, BSF, BSE	01.04 - 11.08	4	75	CSS325	CSS303
Golf V 1.6 FSI	BAG, BLF	10.03 - 07.08	4	85	---	CSS300
Golf V 1.9 TDI	BXE, BKC, BLS	10.03 - 11.08	4	77	---	CSS329
Golf V 1.9 TDI	BXF, BXJ, BRU	05.04 - 11.08	4	66	---	CSS329
Golf V 1.9 TDI 4motion	BXE, BKC, BLS	08.04 - 11.08	4	77	---	CSS329
Golf V 2.0 FSI	AXW, BLR, BLX, BLY, BVX, BVY	01.04 - 11.08	4	110	CSS326	CSS302
Golf V 2.0 FSI 4motion	AXW, BLR, BLX, BLY, BVX, BVY	08.04 - 11.08	4	110	---	CSS302
Golf V 2.0 GTI	AXX, BWA	10.04 - 02.09	4	147	---	CSS302
Golf V 2.0 GTI	AXX, BWA, CAWB	10.04 - 02.09	4	147	CSS313	---
Golf V 2.0 GTI	BPY, AXX, CBFA, CAWB, CCTA	10.04 - 02.09	4	147	CSS325	CSS324
Golf V 2.0 GTI	BYD	09.06 - 12.08	4	169	CSS325	CSS302
Golf V 2.0 SDI	BDK	01.04 - 11.08	4	55	---	CSS329
Golf V 2.0 TDI	AZV	10.03 - 11.08	4	100	---	CSS330
Golf V 2.0 TDI	AZV, CBDA	10.03 ->	4	100	CSS322	---
Golf V 2.0 TDI	BMM	12.04 - 11.08	4	103	---	CSS329
Golf V 2.0 TDI	BMN	11.05 - 11.08	4	125	---	CSS330
Golf V 2.0 TDI 16V	BKD	10.03 - 11.08	4	103	---	CSS330
Golf V 2.0 TDI 16V 4motion	BKD	08.04 - 11.08	4	103	---	CSS330
Golf V 2.0 TDI 4motion	BMM	08.04 - 11.08	4	103	---	CSS329
Golf V Plus 1.6	BSE, BSF	05.05 - 12.13	4	75	---	CSS303
Golf V Plus 1.6 FSI	BLF	01.05 - 05.08	4	85	---	CSS300
Golf V Plus 2.0 FSI	BLR, BLY, BVY, BVZ	05.05 - 06.08	4	110	---	CSS302
Golf V Variant 2.0	BWA, CAWB	06.07 - 07.09	4	147	CSS313	---
Golf V Variant 2.0 TDI	AZV	06.07 - 07.09	4	100	---	CSS330
Golf V Variant 2.0 TDI 16V	CBDB, BKD	06.07 - 07.09	4	103	---	CSS330
Golf V Variant 2.0 TDI 4motion	AZV	06.07 - 07.09	4	100	---	CSS330
Golf VI 1.4	CGGA	10.08 - 11.12	4	59	CSS322	CSS307
Golf VI 1.4 TSI	CAVD	10.08 - 11.12	4	118	CSS322	CSS300
Golf VI 1.4 TSI	CAXA	10.08 - 11.12	4	90	CSS322	CSS300

Typ Type	Motornummer Engine-No.	Baujahr Year	Zyl. Cyl.	KW	Kurbelwellen- sensor Crankshaft S.	Nocken- wellensensor Camshaft S.
Golf VI 1.6	BSE, BSF, CCSA, CMXA	10.08 - 11.12	4	75	CSS325	CSS303
Golf VI 1.6 BiFuel	CHGA	03.09 - 11.12	4	75	CSS325	CSS303
Golf VI 1.6 MultiFuel	CCSA, CMXA	10.08 - 11.12	4	75	CSS325	CSS303
Golf VI 1.6 TDI	CAYB	02.09 - 11.12	4	66	CSS322	---
Golf VI 1.6 TDI	CAYC	02.09 - 11.12	4	77	CSS322	---
Golf VI 1.8 TSI	CDAA	06.09 - 01.11	4	118	CSS313	CSS324
Golf VI 2.0 GTI	CCZB	04.09 - 11.12	4	155	CSS313	---
Golf VI 2.0 GTI	CDLG	05.11 - 11.12	4	173	CSS325	---
Golf VI 2.0 R 4motion	CDLA	11.09 - 05.11	4	195	CSS325	---
Golf VI 2.0 R 4motion	CDLF	11.09 - 11.12	4	199	CSS325	---
Golf VI 2.0 R 4motion	CRZA, CDLC	11.09 - 11.13	4	188	CSS325	---
Golf VI 2.0 TDI	CBAA, CFFA	10.08 - 11.12	4	100	CSS322	---
Golf VI 2.0 TDI	CBAB, CFFB	10.08 - 05.13	4	103	CSS322	---
Golf VI 2.0 TDI	CBBB, CFGB	04.09 - 11.12	4	125	CSS322	---
Golf VI 2.0 TDI	CBDC, CLCA	10.08 - 11.12	4	81	CSS322	---
Golf VI 2.0 TDI 4motion	CBAB, CFFB	05.09 - 05.13	4	103	CSS322	---
Golf VI 2.0 TSI	CCZB	04.09 - 11.12	4	155	---	CSS324
Golf VI Cabriolet 2.0 TDI	CUUA	11.13 ->	4	81	---	CSS331
Golf VI Cabriolet 2.0 TDI	CUUB	11.13 ->	4	110	---	CSS331
Golf VI Convertible 2.0 GTI	CCZB	11.11 ->	4	155	CSS313	---
Golf VI Variant 1.2 TSI	CBZA	05.10 - 11.12	4	63	CSS322	CSS300
Golf VI Variant 1.2 TSI	CBZB	05.09 - 11.12	4	77	CSS322	CSS300
Golf VI Variant 1.6 MultiFuel	CMXA	07.10 - 07.13	4	75	---	CSS303
Golf VI Variant 2.0 TSI	CCZA	07.09 - 07.13	4	147	CSS313	---
Golf VII 1.0 TSI	CHZD	05.15 ->	3	85	---	CSS308
Golf VII 1.0 TSI	CHZD	05.15 ->	3	85	---	CSS308
Golf VII 1.2 TSI	CJZA	11.12 ->	4	77	---	CSS308
Golf VII 1.2 TSI	CJZB, CYVA	08.12 ->	4	63	---	CSS308
Golf VII 1.2 TSI	CYVB	04.14 ->	4	81	---	CSS308
Golf VII 1.4 GTE Hybrid	CUKB	05.14 ->	4	110	---	CSS308
Golf VII 1.4 TGI CNG	CPWA	06.13 ->	4	81	---	CSS308
Golf VII 1.4 TSI	CHPA, CPTA	08.12 ->	4	103	---	CSS308
Golf VII 1.4 TSI	CMBA, CPVA, CXSA	11.12 ->	4	90	---	CSS308
Golf VII 1.4 TSI	CPVB, CZCA	05.14 ->	4	92	---	CSS308
Golf VII 1.4 TSI	CZDA, CZEA	05.14 ->	4	110	---	CSS308
Golf VII 1.4 TSI MultiFuel	CPVA	04.13 ->	4	90	---	CSS308
Golf VII 1.4 TSI MultiFuel	CPVB	12.13 ->	4	92	---	CSS308
Golf VII 1.6	CWVA	05.14 ->	4	81	---	CSS308
Golf VII 1.6 TDI	CLHA	08.12 ->	4	77	---	CSS331
Golf VII 1.6 TDI	CRKA, CLHB, CXXA, DDYB	04.13 ->	4	66	---	CSS331
Golf VII 1.6 TDI	CRKB, CXXB	01.13 ->	4	81	---	CSS331
Golf VII 1.6 TDI 4motion	CLHA	11.12 ->	4	77	---	CSS331
Golf VII 1.6 TDI 4motion	CRKB, CXXB	01.13 ->	4	81	---	CSS331
Golf VII 2.0 GTD	CUNA, DGCA	04.13 ->	4	135	---	CSS331
Golf VII 2.0 GTI	CHHA	04.13 ->	4	169	---	CSS308
Golf VII 2.0 GTI	CHHB, CXCB, CXDA	04.13 ->	4	162	---	CSS308
Golf VII 2.0 GTI	CNTA, CXCA	11.13 ->	4	155	---	CSS308
Golf VII 2.0 GTI Clubsport	CJXE	02.16 ->	4	195	---	CSS308
Golf VII 2.0 R 4motion	CJXB	11.13 ->	4	206	---	CSS308
Golf VII 2.0 R 4motion	CJXC	11.13 ->	4	221	---	CSS308
Golf VII 2.0 TDI	CRLD, CRVA, CYKB, DEJB	11.12 ->	4	81	---	CSS331
Golf VII 2.0 TDI	CRLB, CRBC, CRUA, DEJA	11.12 ->	4	110	---	CSS331
Golf VII 2.0 TDI	CRVC, CRBB	08.12 ->	4	105	---	CSS331
Golf VII 2.0 TDI 4motion	DCYA, CRLB, CKFC, CRBC	11.12 ->	4	110	---	CSS331
Golf Plus 1.2 TSI	CBZB	11.09 - 12.13	4	77	CSS322	CSS300
Golf Plus 1.4 16V	BUD, CGGA	05.06 - 12.13	4	59	CSS322	CSS307
Golf Plus 1.4 TSI	BLG	05.06 - 06.08	4	125	CSS322	CSS300
Golf Plus 1.4 TSI	BMV	05.06 - 06.08	4	103	CSS322	CSS300
Golf Plus 1.4 TSI	CAVD, CNWA	06.08 - 12.13	4	118	CSS322	CSS300

Typ Type	Motornummer Engine-No.	Baujahr Year	Zyl. Cyl.	KW	Kurbelwellen- sensor Crankshaft S.	Nocken- wellensensor Camshaft S.
Golf Plus 1.4 TSI	CAXA	06.07 - 12.13	4	90	CSS322	CSS300
Golf Plus 1.6	CCSA, BSF, CMXA, BSE	05.05 - 12.13	4	75	CSS325	CSS303
Golf Plus 1.6 BiFuel	CHGA	05.09 - 12.13	4	75	CSS325	CSS303
Golf Plus 1.6 MultiFuel	CCSA, CMXA	11.07 - 12.13	4	75	CSS325	CSS303
Golf Plus 1.6 TDI	CAYC	03.09 ->	4	77	CSS322	---
Golf Plus 1.9 TDI	BXE, BKC, BLS	01.05 - 01.09	4	77	---	CSS329
Golf Plus 1.9 TDI	BXF, BXJ, BRU	05.05 - 12.08	4	66	---	CSS329
Golf Plus 2.0 FSI	BLY, BLR, BVZ, BZY	05.05 - 06.08	4	110	CSS326	---
Golf Plus 2.0 TDI	AZV, CBDA, CFHB	05.05 - 12.13	4	100	CSS322	CSS330
Golf Plus 2.0 TDI	BEE	05.05 - 05.07	4	96	---	CSS330
Golf Plus 2.0 TDI	BMM	12.05 - 05.11	4	103	---	CSS329
Golf Plus 2.0 TDI	CBDC, CLCA	01.09 ->	4	81	CSS322	---
Golf Plus 2.0 TDI 16V	BKD, CBDB, CFHC	01.05 - 12.13	4	103	CSS322	CSS330
Golf Sportsvan 1.0 TSI	CHZD	05.15 ->	3	85	---	CSS308
Golf Sportsvan 1.2 TSI	CYVA	05.14 ->	4	63	---	CSS308
Golf Sportsvan 1.2 TSI	CYVB	04.14 ->	4	81	---	CSS308
Golf Sportsvan 1.4 TSI	CPVB, CZCA	04.14 ->	4	92	---	CSS308
Golf Sportsvan 1.4 TSI	CZDA	02.14 ->	4	110	---	CSS308
Golf Sportsvan 1.4 TSI Multifuel	CPVB	04.14 ->	4	92	---	CSS308
Golf Sportsvan 1.6	CWVA	05.14 ->	4	81	---	CSS308
Golf Sportsvan 1.6 TDI	CRKA, CXXA	02.14 ->	4	66	---	CSS331
Golf Sportsvan 1.6 TDI	CRKB, CXXB, DBKA	02.14 ->	4	81	---	CSS331
Golf Sportsvan 2.0 TDI	CRVA, CRLD	05.14 ->	4	81	---	CSS331
Golf Sportsvan 2.0 TDI	DCYA, CRLB	02.14 ->	4	110	---	CSS331
Jetta III 1.4 TSI	CAVD	07.08 - 10.10	4	118	CSS322	CSS300
Jetta III 1.6	BGU, CCSA, BSF, BSE	10.05 - 10.10	4	75	CSS325	CSS303
Jetta III 1.6 FSI	BLF	09.05 - 10.10	4	85	---	CSS300
Jetta III 1.6 MultiFuel	CCSA	01.08 - 10.10	4	75	CSS325	CSS303
Jetta III 1.6 TDI	CAYB	12.09 - 10.10	4	66	CSS322	---
Jetta III 1.6 TDI	CAYC	06.09 - 10.10	4	77	CSS322	---
Jetta III 1.9 TDI	BXE, BKC, BLS	08.05 - 10.10	4	77	---	CSS329
Jetta III 2.0 FSI	BLX, BLY, BLR, BVZ, BZY	08.05 - 10.10	4	110	CSS326	CSS302
Jetta III 2.0 TDI	AZV, CBDA	09.05 - 10.10	4	100	CSS322	CSS330
Jetta III 2.0 TDI	BKD, CBDB, CFHC	08.05 - 10.10	4	103	CSS322	---
Jetta III 2.0 TDI	BMM	10.05 - 10.10	4	103	---	CSS329
Jetta III 2.0 TDI	BMN, CEGA	10.06 - 10.10	4	125	CSS322	CSS330
Jetta III 2.0 TDI 16V	CBEA, CJAA, CBDB, BKD	08.05 - 10.10	4	103	---	CSS330
Jetta III 2.0 TFSI	BPY, BWA	10.05 - 10.10	4	147	---	CSS302
Jetta III 2.0 TFSI	CAWB, CBFA, CCTA, CCZA	10.05 - 10.10	4	147	CSS313	---
Jetta III 2.0 TFSI	CBFA, CCZA, CAWB, CCTA	10.05 - 10.10	4	147	CSS325	CSS324
Jetta III 2.0 TFSI	CAWA	03.08 - 10.10	4	125	CSS313	---
Jetta IV 1.2 TSI	CBZB	02.11 ->	4	77	CSS322	CSS300
Jetta IV 1.4 TSI	CAVD, CTHD	04.11 ->	4	118	---	CSS300
Jetta IV 1.4 TSI	CZCA	08.14 ->	4	92	---	CSS308
Jetta IV 1.4 TSI	CZDA, CZTA	08.14 ->	4	110	---	CSS308
Jetta IV 1.4 TSI Hybrid	CNLA, CRJA	04.11 ->	4	110	---	CSS308
Jetta IV 1.8 TSI	CPKA, CPRA	07.14 ->	4	125	---	CSS308
Jetta IV 2.0	CKJA, CBPA	06.10 ->	4	85	---	CSS316
Jetta IV 2.0 TDI	CFFB, CFHC, CJAA, CLBB	02.11 ->	4	103	CSS322	---
Jetta IV 2.0 TDI	CUUB	08.14 ->	4	110	---	CSS331
Jetta IV 2.0 TSI	CBFA, CCTA, CCZA	12.10 ->	4	147	CSS313	---
Jetta IV 2.0 TSI	CBFA, CCTA, CCZA	12.10 ->	4	147	---	CSS324
Jetta IV 2.0 TSI	CPLA, CPPA	12.12 ->	4	155	---	CSS308
Lupo 1.0	AER, AHT, ALD, ALL, ANV, AUC	09.98 - 07.05	4	37	---	CSS300
Lupo 1.2 TDI 1.4 TDI	AMF	01.99 - 07.05	3	55	---	CSS328
Lupo 1.2 TDI 3L	AYZ, ANY	07.99 - 07.05	3	45	---	CSS328
Lupo 1.4	AUD	10.00 - 07.05	4	44	---	CSS300
Lupo 1.4 16V	AFK, ANM, AQQ, AUB	08.99 - 07.05	4	74	---	CSS307
Lupo 1.4 16V	AHW, AKQ, APE, AXP, BCA	09.98 - 07.05	4	55	---	CSS307

Typ Type	Motornummer Engine-No.	Baujahr Year	Zyl. Cyl.	KW	Kurbelwellen- sensor Crankshaft S.	Nocken- wellensensor Camshaft S.
Lupo 1.4 FSI	ARR	02.01 - 07.05	4	77	---	CSS300
Multivan T5 1.9 TDI	AXB	04.03 - 11.09	4	77	---	CSS328
Multivan T5 1.9 TDI	BRR	01.06 - 11.09	4	62	---	CSS329
Multivan T5 1.9 TDI	BRS	06.06 - 11.09	4	75	---	CSS329
Multivan T5 2.0	AXA	11.03 ->	4	85	CSS326	CSS316
Multivan T5 2.0 BiTDi	CFCA	09.09 ->	4	132	CSS322	---
Multivan T5 2.0 BiTDi 4motion	CFCA	09.09 ->	4	132	CSS322	---
Multivan T5 2.0 TDI	CAAA	09.09 ->	4	62	CSS322	---
Multivan T5 2.0 TDI	CAAB	09.09 ->	4	75	CSS322	---
Multivan T5 2.0 TDI	CAAC, CCHA	09.09 ->	4	103	CSS322	---
Multivan T5 3.2 V6	BDL	02.04 - 06.04	6	170	---	CSS323
Multivan T5 3.2 V6	BKK, CFLA	02.04 - 11.09	6	173	---	CSS323
Multivan T5 3.2 V6 4motion	BKK, CFLA	07.04 - 11.09	6	173	---	CSS323
Multivan T6 2.0 TDI	CAAC	04.15 ->	4	103	CSS322	---
Multivan T6 2.0 TDI	CFCA	04.15 ->	4	132	CSS322	---
Multivan T6 2.0 TDI	CXGB, CAAB	04.15 ->	4	75	CSS322	---
Multivan T6 2.0 TDI 4motion	CAAC	06.15 ->	4	103	CSS322	---
Multivan T6 2.0 TDI 4motion	CFCA	06.15 ->	4	132	CSS322	---
New Beetle 1.2 TSI	CBZB	07.11 ->	4	77	---	CSS300
New Beetle 1.4	BCA	11.01 - 09.10	4	55	---	CSS307
New Beetle 1.4 TSI	CTKA, CAVD, CTHD, CNWA	04.11 ->	4	118	---	CSS300
New Beetle 1.6	AWH	10.99 - 09.00	4	74	CSS325	CSS316
New Beetle 1.6	AYD	06.00 - 09.10	4	75	---	CSS303
New Beetle 1.6	AYD, BFS	06.00 - 09.10	4	75	CSS325	---
New Beetle 1.8 T	APH, AVC, AWU, AWV	10.99 - 09.10	4	110	CSS311	---
New Beetle 1.8 T	AWP, BNU	11.01 - 06.05	4	132	CSS325	---
New Beetle 1.8 T	AWV, APH, AVC, AGU, AWU	10.99 - 09.10	4	110	CSS325	---
New Beetle 1.9 TDI	ALH	01.98 - 02.01	4	66	CSS315	---
New Beetle 1.9 TDI	ATD, BEW	02.01 - 09.10	4	74	CSS315	CSS328
New Beetle 1.9 TDI	BSW	07.05 - 09.10	4	77	---	CSS328
New Beetle 2.0	AEG, AQY, AVH	01.98 - 09.10	4	85	CSS311	CSS316
New Beetle 2.3 V5	AQN	10.00 - 09.10	5	125	---	CSS323
New Beetle Cabriolet 1.2 TSI	CBZB	12.12 ->	4	77	---	CSS300
New Beetle Cabriolet 1.4	BCA	01.03 - 09.10	4	55	---	CSS301
New Beetle Cabriolet 1.4 TSI	CTKA, CAVD, CTHD, CNWA	12.12 ->	4	118	---	CSS300
New Beetle Cabriolet 1.6	BFS	01.03 - 09.10	4	75	CSS325	CSS303
New Beetle Cabriolet 1.8 T	AWU	01.03 - 09.10	4	110	CSS311	---
New Beetle Cabriolet 1.8 T	AWV, AWU, BKF	01.03 - 09.10	4	110	CSS325	---
New Beetle Cabriolet 1.9 TDI	BSW	07.05 - 09.10	4	77	---	CSS328
New Beetle Cabriolet 2.0	AZJ	09.02 - 10.10	4	85	CSS311	CSS316
New Beetle Cabriolet 2.0	AZJ, BEV, BDC, BGD	09.02 - 10.10	4	85	CSS325	---
New Beetle RSI 3.2 4motion	AXJ	04.00 - 05.01	6	165	---	CSS323
Passat 1.4 GTE Hybrid	CUKC	06.15 ->	4	115	---	CSS308
Passat 1.4 TSI	CAXA	05.07 - 07.10	4	90	CSS322	CSS300
Passat 1.4 TSI	CZCA	11.14 ->	4	92	---	CSS308
Passat 1.4 TSI	CZDA, CZEA	11.14 ->	4	110	---	CSS308
Passat 1.4 TSI EcoFuel	CDGA	01.09 - 07.10	4	110	CSS322	CSS300
Passat 1.4 TSI MultiFuel	CKMA	11.10 ->	4	118	CSS322	---
Passat 1.6	ADP, AHL (10.96-), ANA, ARM	10.96 - 11.00	4	74	---	CSS323
Passat 1.6	AEK, AFT	10.94 - 08.96	4	74	CSS319	---
Passat 1.6	AHL, ANA, ARM	10.96 - 11.00	4	74	CSS311	CSS316
Passat 1.6	ALZ	11.00 - 05.05	4	75	---	CSS303
Passat 1.6	BSE, BSF	05.05 - 07.10	4	75	CSS325	CSS303
Passat 1.6	ALZ	11.00 - 10.01	4	75	---	CSS316
Passat 1.6 TDI	CAYC	08.09 - 07.10	4	77	CSS322	---
Passat 1.6 TDI	DCXA, DCZA	08.14 ->	4	88	---	CSS331
Passat 1.8 TSI	BZB, CDAA	05.07 - 07.10	4	118	CSS313	---
Passat 1.8 TSI	BZB, CDAA	05.07 - 07.10	4	118	---	CSS324
Passat 1.8 TSI	BZB, CDAA	05.07 - 07.10	4	118	---	CSS320

Typ Type	Motornummer Engine-No.	Baujahr Year	Zyl. Cyl.	KW	Kurbelwellen- sensor Crankshaft S.	Nocken- wellensensor Camshaft S.
Passat 1.8 TSI	CDA A	08.10 - 12.14	4	118	CSS313	---
Passat 1.8 TSI	CJSA, CJSC	02.15 ->	4	132	---	CSS308
Passat 1.9 TDI	BXE, BKC, BLS	03.05 - 11.08	4	77	---	CSS329
Passat 2.0	2E, ADY, AGG	02.90 - 08.96	4	85	CSS309	---
Passat 2.0	AEP	03.95 - 08.96	4	79	CSS309	---
Passat 2.0	AZM, BFF	11.00 - 05.05	4	85	CSS311	CSS316
Passat 2.0 16V	ABF	01.94 - 08.96	4	110	CSS309	---
Passat 2.0 4motion	AZM	11.00 - 05.05	4	85	CSS311	---
Passat 2.0 Blue TDI	CBAC	01.09 - 11.10	4	105	CSS322	---
Passat 2.0 FSI	CAWB, CBFA, CCTA, CCZA	07.05 - 07.10	4	147	CSS313	---
Passat 2.0 FSI	CAWB, CBFA, CCTA, CCZA	07.05 - 07.10	4	147	---	CSS324
Passat 2.0 FSI	BLY, BLR, BVZ, BZY	03.05 - 07.10	4	110	CSS326	CSS302
Passat 2.0 FSI	CBFA, CCZA, CAWB, CCTA	07.05 - 07.10	4	147	CSS325	---
Passat 2.0 FSI 4motion	BVX, BLX, BLY	09.05 - 07.10	4	110	CSS326	---
Passat 2.0 Syncro	2E, ADY, AGG	10.90 - 08.96	4	85	CSS309	---
Passat 2.0 TDI	BMA, CBAA	03.05 - 11.10	4	100	CSS322	---
Passat 2.0 TDI	BMP	03.05 - 05.09	4	103	---	CSS329
Passat 2.0 TDI	BUZ	08.05 - 05.09	4	120	---	CSS330
Passat 2.0 TDI	BVE	08.05 - 07.06	4	90	---	CSS330
Passat 2.0 TDI	BWV	11.05 - 05.07	4	88	---	CSS330
Passat 2.0 TDI	CBAA, BMA	03.05 - 11.10	4	100	---	CSS330
Passat 2.0 TDI	CBBB, BMR	08.05 - 07.10	4	125	---	CSS330
Passat 2.0 TDI	CBDC	11.08 - 07.10	4	81	CSS322	---
Passat 2.0 TDI	CFFA	08.10 ->	4	100	CSS322	---
Passat 2.0 TDI	CFFB	08.10 ->	4	103	CSS322	---
Passat 2.0 TDI	CFGB, CLLA	08.10 ->	4	125	CSS322	---
Passat 2.0 TDI	DBGA, CRLB, DFCA	11.14 ->	4	110	---	CSS331
Passat 2.0 TDI	DFCA, DDAA	11.14 ->	4	140	---	CSS331
Passat 2.0 TDI	BMR, CBBB	08.05 ->	4	125	CSS322	---
Passat 2.0 TDI 16V	BKP, CBAB	03.05 - 07.10	4	103	CSS322	CSS330
Passat 2.0 TDI 16V 4motion	BKP, CBAB	03.05 - 08.10	4	103	CSS322	CSS330
Passat 2.0 TDI 4motion	BMP	03.05 - 05.09	4	103	---	CSS329
Passat 2.0 TDI 4motion	CBBB	05.09 ->	4	125	CSS322	---
Passat 2.0 TDI 4motion	CFFB	08.10 ->	4	103	CSS322	---
Passat 2.0 TDI 4motion	CFGB, CLLA	08.10 ->	4	125	CSS322	---
Passat 2.0 TDI 4motion	CRLB, DFCA	02.15 ->	4	110	---	CSS331
Passat 2.0 TDI 4motion	DFCA, DDAA	11.14 ->	4	140	---	CSS331
Passat 2.0 TSI	CCZB	11.10 - 12.14	4	155	CSS313	CSS324
Passat 2.0 TSI	CHHB, CXDA	02.15 ->	4	162	---	CSS308
Passat 2.0 TSI 4motion	CJXA	05.15 ->	4	206	---	CSS308
Passat 2.3 V5	AZX	11.00 - 05.05	5	125	---	CSS323
Passat 2.3 V5 4motion	AZX	11.00 - 05.05	5	125	---	CSS323
Passat 2.3 VR5	AGZ (10.96-.)	10.96 - 11.00	5	110	---	CSS323
Passat 2.3 VR5 Syncro/4motion	AGZ (10.97-.)	10.97 - 11.00	5	110	---	CSS323
Passat 2.8 4motion	AMX, ATQ	11.00 - 05.05	6	142	CSS311	---
Passat 2.8 V6	ACK, APR	08.96 - 11.00	6	142	CSS311	---
Passat 4.0 W8 4motion	BDN	09.01 - 09.04	8	202	---	CSS323
Passat Alltrack 1.8 TSI	CDA A	01.12 - 12.14	4	118	CSS313	---
Passat Alltrack 1.8 TSI	CDAB	01.12 - 12.14	4	112	CSS313	---
Passat Alltrack 2.0 TSI 4motion	CCZB	01.12 - 12.14	4	155	CSS313	---
Passat CC 1.4 TSI MultiFuel	CKMA	01.11 ->	4	118	CSS322	---
Passat CC 1.8 TSI	BZB, CDA A	06.08 - 01.12	4	118	CSS313	---
Passat CC 2.0 TDI	CBAA, CFFA	06.08 - 05.11	4	100	CSS322	---
Passat CC 2.0 TDI	CBAB, CFFB	06.08 ->	4	103	CSS322	---
Passat CC 2.0 TDI	CBBB, CFGB, CLLA	06.08 ->	4	125	CSS322	---
Passat CC 2.0 TDI Blue TDI	CBAC	05.09 - 11.10	4	105	CSS322	---
Passat CC 2.0 TSI	CAWB, CCZA	06.08 - 01.12	4	147	CSS313	---
Passat CC 2.0 TSI	CCZB	11.10 - 01.12	4	155	CSS313	---
Passat Variant 2.0 FSI	BLY, BLR, BVZ, BZY	08.05 - 11.10	4	110	CSS326	---

Typ Type	Motornummer Engine-No.	Baujahr Year	Zyl. Cyl.	KW	Kurbelwellen- sensor Crankshaft S.	Nocken- wellensensor Camshaft S.
Passat Variant 2.0 FSI 4motion	BVX, BLX, BLY	09.05 - 11.10	4	110	CSS326	---
Phaeton 3.0 V6 TDI 4motion	BMK	09.04 - 05.07	6	165	---	CSS332
Phaeton 3.0 V6 TDI 4motion	CARA	06.07 ->	6	171	---	CSS324
Phaeton 3.0 V6 TDI 4motion	CARB	11.08 ->	6	176	---	CSS324
Phaeton 3.2 V6	AYT, BKL	04.02 - 05.05	6	177	---	CSS323
Phaeton 3.2 V6 4motion	BKL, BRK	02.04 - 11.08	6	177	---	CSS323
Phaeton 6.0 W12 4motion	BAN	04.02 - 05.05	12	309	---	CSS323
Phaeton 6.0 W12 4motion	BRN, BTT	05.05 - 03.16	12	331	---	CSS323
Polo 1.0	ALD, AUC	10.99 - 09.01	4	37	---	CSS300
Polo 1.0	CHYA	01.14 ->	3	44	---	CSS308
Polo 1.0	CHYB	01.14 ->	3	55	---	CSS308
Polo 1.0 TSI	CHZB	11.14 ->	3	70	---	CSS308
Polo 1.0 TSI	CHZC	11.14 ->	3	81	---	CSS308
Polo 1.2	AWY, BMD	01.02 - 05.07	3	40	CSS304	CSS306
Polo 1.2	BBM	05.07 - 11.09	3	44	CSS304	CSS300
Polo 1.2	CGPA	06.09 ->	3	51	CSS304	---
Polo 1.2	CGPB	06.09 ->	3	44	CSS304	---
Polo 1.2 12V	AZQ, BME	10.01 - 07.07	3	47	CSS304	CSS300
Polo 1.2 12V	BZG	05.07 - 11.09	3	51	CSS304	CSS300
Polo 1.2 TDI	CFWA	10.09 ->	4	55	CSS322	---
Polo 1.2 TSI	CBZB	10.09 ->	4	77	CSS322	CSS300
Polo 1.2 TSI	CBZC	05.11 - 05.14	4	66	CSS325	CSS300
Polo 1.2 TSI	CJZD	01.14 ->	4	81	---	CSS308
Polo 1.2 TSI 16V	CJZC	02.14 ->	4	66	---	CSS308
Polo 1.4	AKP	10.99 - 09.01	4	40	---	CSS300
Polo 1.4	BBY	07.03 - 07.05	4	55	---	CSS307
Polo 1.4	CDDA, CGGB	06.09 ->	4	63	CSS322	CSS307
Polo 1.4	AKK, AUD	10.99 - 09.01	4	44	---	CSS300
Polo 1.4 16V	AFK, AQQ, AUB	10.99 - 09.01	4	74	---	CSS307
Polo 1.4 16V	AHW, APE, AUA	10.99 - 09.01	4	55	---	CSS307
Polo 1.4 16V	AUA, BBY, BKY	10.01 - 05.08	4	55	---	CSS307
Polo 1.4 16V	AUB, BBZ	10.01 - 07.05	4	74	---	CSS307
Polo 1.4 16V	BUD	05.06 - 11.09	4	59	CSS322	---
Polo 1.4 BiFuel	CMAA	03.10 - 01.11	4	60	CSS322	CSS307
Polo 1.4 FSI	AXU	05.02 - 07.06	4	63	---	CSS300
Polo 1.4 GTI	CAVE	05.10 ->	4	132	CSS322	CSS300
Polo 1.4 TDI	AMF	10.99 - 09.01	3	55	---	CSS328
Polo 1.4 TDI	AMF, BAY	10.01 - 06.05	3	55	---	CSS328
Polo 1.4 TDI	BMS, BNV	04.05 - 11.09	3	59	---	CSS328
Polo 1.4 TDI	BMS, BNV	04.05 - 11.09	3	59	---	CSS329
Polo 1.4 TDI	BNM, BWB	04.05 - 11.09	3	51	---	CSS328
Polo 1.4 TDI	BNM, BWB	04.05 - 11.09	3	51	---	CSS329
Polo 1.4 TSI	CPTA	10.12 ->	4	103	---	CSS308
Polo 1.4 TSI	CZEA	05.14 ->	4	110	---	CSS308
Polo 1.6	CWVA	07.14 ->	4	81	---	CSS308
Polo 1.6	CWVB	07.14 ->	4	66	---	CSS308
Polo 1.6 16V	BTS	05.06 - 11.09	4	77	CSS322	---
Polo 1.6 16V GTI	AJV	09.98 - 10.99	4	88	---	CSS301
Polo 1.6 BiFuel	CNKA	01.11 ->	4	60	CSS322	CSS300
Polo 1.6 TDI	CAYA	06.09 ->	4	55	CSS322	---
Polo 1.6 TDI	CAYB	06.09 ->	4	66	CSS322	---
Polo 1.6 TDI	CAYC	06.09 ->	4	77	CSS322	---
Polo 1.8 GTI	BJX	09.05 - 11.09	4	110	CSS325	CSS316
Polo 1.8 GTI	DAJA, DAJB	11.14 ->	4	141	---	CSS308
Polo 1.8 Gti Cup Edition	BBU	05.06 - 11.09	4	132	---	CSS316
Polo 1.8 GTi Cup Edition	BBU	05.06 - 11.09	4	132	CSS325	CSS316
Polo 1.9 TDI	BMT, AXR, ATD	10.01 - 11.09	4	74	---	CSS329
Polo 120 1.6 16V GTI	AJV	09.98 - 10.99	4	88	---	CSS307
Polo Classic 100 1.6	AEH, AFT, AKL, APF, AUR	12.95 - 09.01	4	74	CSS311	CSS316

Typ Type	Motornummer Engine-No.	Baujahr Year	Zyl. Cyl.	KW	Kurbelwellen- sensor Crankshaft S.	Nocken- wellensensor Camshaft S.
Polo Classic 60 1.4	AEX, AKK, AKV, ANW, APQ	12.95 - 09.01	4	44	---	CSS300
Polo Classic 75 1.4 16V	APE, AUA	10.99 - 09.01	4	55	---	CSS307
Scirocco 1.4 TSI	CAVD, CNWA	05.08 ->	4	118	CSS322	CSS300
Scirocco 1.4 TSI	CAXA	08.08 ->	4	90	CSS322	CSS300
Scirocco 1.4 TSI	CXSB, CZCA	11.13 ->	4	92	---	CSS308
Scirocco 1.4 TSI	CZDA	07.15 ->	4	110	---	CSS308
Scirocco 2.0 R	CDLA	11.09 ->	4	195	CSS325	---
Scirocco 2.0 R	CDLC	11.09 ->	4	188	CSS325	---
Scirocco 2.0 TDI	CBBB	05.09 ->	4	125	CSS322	---
Scirocco 2.0 TDI	CBDB, CFHC	08.08 ->	4	103	CSS322	---
Scirocco 2.0 TDI	CFHB	11.10 ->	4	100	CSS322	---
Scirocco 2.0 TDI	CUUB	11.13 ->	4	110	---	CSS331
Scirocco 2.0 TSI	CAWB	05.08 - 11.09	4	147	CSS313	CSS324
Scirocco 2.0 TSI	CCZB	11.09 ->	4	155	CSS313	CSS324
Scirocco 2.0 TSI	CULA	11.13 ->	4	132	---	CSS308
Scirocco 2.0 TSI	CULC	11.13 ->	4	162	---	CSS308
Sharan 1.4 TSI	CZDA	05.15 ->	4	110	---	CSS308
Sharan 1.8 T 20V	AJH, AWC	09.97 - 03.10	4	110	CSS311	---
Sharan 1.8 T 20V	AWC, AJH	09.97 - 03.10	4	110	CSS326	---
Sharan 1.9 TDI	ASZ	11.02 - 03.10	4	96	---	CSS328
Sharan 1.9 TDI	BTB	06.05 - 03.10	4	110	---	CSS328
Sharan 1.9 TDI	BVK, AUY	04.00 - 03.10	4	85	---	CSS328
Sharan 1.9 TDI 4motion	BVK, AUY	04.00 - 03.10	4	85	---	CSS328
Sharan 2.0	ADY,ATM	09.95 - 03.10	4	85	CSS309	CSS316
Sharan 2.0	ATM, ADY	09.95 - 03.10	4	85	CSS326	---
Sharan 2.0 LPG	ATM	04.06 - 03.10	4	85	CSS326	CSS316
Sharan 2.0 TDI	BRT	11.05 - 03.10	4	103	---	CSS329
Sharan 2.0 TDI	BVH	11.05 - 03.10	4	100	---	CSS329
Sharan 2.0 TDI	CFFA	05.10 ->	4	100	CSS322	---
Sharan 2.0 TDI	CFFB	05.10 ->	4	103	CSS322	---
Sharan 2.0 TDI	CFGB	08.10 ->	4	125	CSS322	---
Sharan 2.0 TDI 4motion	CFFA	05.11 - 05.12	4	100	CSS322	---
Sharan 2.0 TDI 4motion	CFFB	05.11 ->	4	103	CSS322	---
Sharan 2.0 TSI	CCZA	12.10 ->	4	147	CSS313	CSS324
Sharan 2.0 TSI	DEDA	05.15 ->	4	162	---	CSS308
Sharan 2.8 V6 24V	AYL	04.00 - 03.10	6	150	---	CSS323
Sharan 2.8 V6 24V 4motion	AYL	04.00 - 03.10	6	150	---	CSS323
Sharan 2.8 VR6	AAA, AMY	09.00 - 04.00	6	128	---	CSS323
Sharan 2.8 VR6 Syncro	AAA, AMY	11.96 - 04.00	6	128	---	CSS323
Tiguan 1.4 TSI	BWK, CAVA	05.08 ->	4	110	CSS322	CSS300
Tiguan 1.4 TSI	CAVD, CTHD	05.11 ->	4	118	---	CSS300
Tiguan 1.4 TSI	CAXA	08.10 ->	4	90	CSS322	CSS300
Tiguan 1.4 TSI	CZCA	01.16 ->	4	92	---	CSS308
Tiguan 1.4 TSI	CZDA	05.15 ->	4	110	---	CSS308
Tiguan 1.4 TSI	CZDA, CZEA	05.16 ->	4	110	---	CSS308
Tiguan 1.4 TSI	CZDB	05.15 ->	4	92	---	CSS308
Tiguan 1.4 TSI 4motion	BWK, CAVA	09.07 ->	4	110	CSS322	CSS300
Tiguan 1.4 TSI 4motion	CAVD, CTHD	05.11 ->	4	118	---	CSS300
Tiguan 1.4 TSI 4motion	CZDA, CZEA	05.16 ->	4	110	---	CSS308
Tiguan 2.0 TDI	CDAB, CFFB	03.08 ->	4	103	CSS322	---
Tiguan 2.0 TDI	CFFD	05.10 ->	4	81	CSS322	---
Tiguan 2.0 TDI	CUVC	05.15 ->	4	110	---	CSS331
Tiguan 2.0 TDI 4motion	CBAA, CFFA	11.07 ->	4	100	CSS322	---
Tiguan 2.0 TDI 4motion	CBAB, CFFB	09.07 ->	4	103	CSS322	---
Tiguan 2.0 TDI 4motion	CBBA	02.08 - 08.09	4	120	CSS322	---
Tiguan 2.0 TDI 4motion	CBBB, CFGB	09.07 ->	4	125	CSS322	---
Tiguan 2.0 TDI 4motion	CUWA	05.15 ->	4	135	---	CSS331
Tiguan 2.0 TFSI 4motion	CAWA, CCZC	09.07 ->	4	125	CSS313	CSS324
Tiguan 2.0 TFSI 4motion	CAWB, CCTA, CCZA	09.07 ->	4	147	CSS313	CSS324

Typ Type	Motornummer Engine-No.	Baujahr Year	Zyl. Cyl.	KW	Kurbelwellen- sensor Crankshaft S.	Nocken- wellensensor Camshaft S.
Tiguan 2.0 TSI 4motion	CCZD	05.11 ->	4	132	CSS313	---
Tiguan 2.0 TSI 4motion	CHHB	06.16 ->	4	162	---	CSS308
Tiguan 2.0 TSI 4motion	CZPA	01.16 ->	4	132	---	CSS308
Tiguan 2.0 TSI 4motion/2.0 TSI	CCZB	05.11 ->	4	155	CSS313	---
Touareg 3.0 TDI	BUN, CASB	04.06 - 05.10	6	155	CSS326	CSS324
Touareg 3.0 TDI V6	CASA, CASC	11.07 - 05.10	6	176	CSS326	CSS324
Touareg 3.0 TDI V6	CASA, CNRB	01.10 ->	6	176	---	CSS324
Touareg 3.0 TDI V6	CASD, CJMA	01.10 ->	6	150	---	CSS324
Touareg 3.0 TDI V6	CATA, BKS	11.04 - 05.10	6	165	CSS326	---
Touareg 3.0 TSI V6 Hybrid	CGEA, CGFA	04.10 ->	6	245	---	CSS324
Touareg 3.0 V6 TDI	BKS, CATA	11.04 - 05.10	6	165	---	CSS332
Touareg 3.2 V6	AZZ (10.02-), BKJ (05.03-), BMW, BMX, BRJ	10.02 - 11.06	6	162	---	CSS323
Touareg 3.2 V6	BMW	11.04 - 11.06	6	177	---	CSS323
Touareg 4.2 FSI V8	BAR	06.06 - 05.10	8	257	---	CSS324
Touareg 4.2 FSI V8	CGNA	01.11 ->	8	265	---	CSS324
Touareg 4.2 TDI V8	CKDA	01.10 ->	8	250	---	CSS324
Touareg 6.0 W12	BJN, CFRA	08.04 - 05.10	12	331	---	CSS323
Touran 1.2 TSI	CBZB	05.10 - 05.15	4	77	CSS322	CSS300
Touran 1.2 TSI	CYVB	05.15 ->	4	81	---	CSS308
Touran 1.4 FSI	BLG, CAVB	11.06 - 05.10	4	125	CSS322	CSS300
Touran 1.4 TSI	BMY, CAVC	02.06 - 05.10	4	103	CSS322	CSS300
Touran 1.4 TSI	CZDA	05.15 ->	4	110	---	CSS308
Touran 1.4 TSI EcoFuel	CDGA	05.09 - 05.10	4	110	CSS322	CSS300
Touran 1.6	BGU, BSF, BSE	07.04 - 05.10	4	75	CSS325	---
Touran 1.6 FSI	BAG, BLF, BLP	02.03 - 01.07	4	85	---	CSS300
Touran 1.6 FSI	BGU, BSE, BSF	07.03 - 05.10	4	75	---	CSS303
Touran 1.6 TDI	CAYB	05.10 ->	4	66	CSS322	---
Touran 1.6 TDI	CAYC	05.10 ->	4	77	CSS322	---
Touran 1.6 TDI	CRKB	05.15 - 05.16	4	81	---	CSS331
Touran 1.8 TSI	CJSA	11.15 ->	4	132	---	CSS308
Touran 1.9 TDI	AVQ	02.03 - 05.04	4	74	---	CSS329
Touran 1.9 TDI	BXE, BKC, BLS	08.03 - 05.10	4	77	---	CSS329
Touran 1.9 TDI	BXF, BXJ, BRU	11.04 - 05.10	4	66	---	CSS329
Touran 2.0 Eco Fuel	BSX	02.06 - 05.09	4	80	CSS325	CSS316
Touran 2.0 FSI	BLX, BLY, BLR, AXW, BVZ, BYY	10.03 - 11.05	4	110	CSS326	CSS302
Touran 2.0 TDI	AZV	02.03 - 05.10	4	100	---	CSS330
Touran 2.0 TDI	BMM	12.05 - 05.10	4	103	---	CSS329
Touran 2.0 TDI	BMN	12.05 - 05.10	4	125	---	CSS330
Touran 2.0 TDI	BMN, CFJA	12.05 ->	4	125	CSS322	---
Touran 2.0 TDI	CLCA	05.10 ->	4	81	CSS322	---
Touran 2.0 TDI	DFGA, DFEA	05.15 ->	4	110	---	CSS331
Touran 2.0 TDI 16V	BKD	08.03 - 05.10	4	103	---	CSS330
Transporter T4 2.8 VR6	AES (11.95-)	11.95 - 04.00	6	103	---	CSS323
Transporter T4 2.8 VR6	AMV	04.00 - 04.03	6	150	---	CSS323
Transporter T5 1.9 TDI	AXB	04.03 - 11.09	4	77	---	CSS328
Transporter T5 1.9 TDI	AXC	04.03 - 11.09	4	63	---	CSS328
Transporter T5 1.9 TDI	BRR	01.06 - 11.09	4	62	---	CSS329
Transporter T5 1.9 TDI	BRS	06.06 - 11.09	4	75	---	CSS329
Transporter T5 2.0	AXA	11.03 ->	4	85	CSS326	CSS316
Transporter T5 2.0 BiTDI	CFCA	09.09 ->	4	132	CSS322	---
Transporter T5 2.0 BiTDI 4motion	CFCA	09.09 ->	4	132	CSS322	---
Transporter T5 2.0 TDI	CAAA	09.09 ->	4	62	CSS322	---
Transporter T5 2.0 TDI	CAAB	09.09 ->	4	75	CSS322	---
Transporter T5 2.0 TDI 4motion	CAAC, CCHA	09.09 ->	4	103	CSS322	---
Transporter T5 3.2 V6	BKK, CFLA	02.04 - 11.09	6	173	---	CSS323
Transporter T5 3.2 V6 4motion	BKK, CFLA	11.03 - 11.09	6	173	---	CSS323
Transporter T6 2.0 TDI	CAAA, CXGA	04.15 ->	4	62	CSS322	---
Transporter T6 2.0 TDI	CAAC	04.15 ->	4	103	CSS322	---
Transporter T6 2.0 TDI	CFCA	04.15 ->	4	132	CSS322	---

Typ Type	Motornummer Engine-No.	Baujahr Year	Zyl. Cyl.	KW	Kurbelwellen- sensor Crankshaft S.	Nocken- wellensensor Camshaft S.
Transporter T6 2.0 TDI	CXGB, CAAB	04.15 ->	4	75	CSS322	---
Transporter T6 2.0 TDI 4motion	CAAC	06.15 ->	4	103	CSS322	---
Transporter T6 2.0 TDI 4motion	CFCA	06.15 ->	4	132	CSS322	---
UP 1.0	CHYA	08.11 ->	3	44	---	CSS308
UP 1.0	CHYB	08.11 ->	3	55	---	CSS308
UP 1.0 EcoFuel	CPGA	11.12 ->	3	50	---	CSS308
V 2.0 FSI 4motion	BVX, BLX	08.04 - 11.08	4	110	CSS326	---
Vento 1.6	AEK, AFT	10.94 - 09.98	4	74	CSS319	---
Vento 2.0	2E, ADY, AGG, AKR	11.91 - 09.98	4	85	CSS309	---
<b>Volvo</b>						
240 2.3i Kat.	B 230F	08.86 - 07.93	4	85	CSS100	---
240 2.4 Diesel	D24	08.87 - 08.93	6	58	CSS100	---
340 - 360 1.4	B 143 E	08.82 - 08.85	4	46	CSS1523	---
340 - 360 2.0	B 200 E	08.84 - 07.86	4	87	CSS1523	---
340 - 360 2.0	B 200 E, B 200 F	08.86 - 07.88	4	82	CSS1523	---
340 - 360 2.0	B 200 F	08.88 - 07.89	4	80	CSS1523	---
340 - 360 2.0	B 200 F	08.87 - 07.88	4	81	CSS1523	---
340 - 360 2.0	B 200 K	08.84 - 07.87	4	77	CSS1523	---
740 2.3	B 230 F	08.87 - 07.92	4	85	CSS100	---
740 2.3	B 234 F	08.88 - 08.92	4	111	CSS100	---
740 2.3 Turbo	B 230 FT	08.89 - 07.90	4	140	CSS100	---
740 2.3 Turbo	B 230 FT	08.89 - 07.90	4	121	CSS100	---
740 2.4 Diesel	D24	08.84 - 07.92	6	60	CSS100	---
740 2.4 Turbo Diesel	D24 T	09.85 - 07.92	6	80	CSS100	---
760 2.4 D	D24	01.82 - 07.92	6	60	CSS100	---
760 2.4 TD Interc.	D24 TIC	08.87 - 07.92	6	85	CSS100	---
760 2.4 Turbo Diesel	D24 T	04.87 - 07.92	6	80	CSS100	---
940 2.0	B 200 F	01.92 - 07.94	4	82	CSS100	---
940 2.3	B 230 FD	08.92 - 07.94	4	85	CSS100	---
940 2.3	B 230FB , B 230G	08.90 - 12.94	4	96	CSS100	---
940 2.3	B 234F, B 234G	08.90 - 07.91	4	114	CSS100	---
940 2.3 Turbo	B 230 FT	08.90 - 07.94	4	121	CSS100	---
940 2.4 D	D24	08.90 - 12.94	6	60	CSS100	---
940 2.4 TD	D24T	08.90 - 12.94	6	80	CSS100	---
940 2.4 TD Interc.	D24T IC	08.90 - 12.94	6	90	CSS100	---
940 II 2.3	B 230 FB	08.94 - 10.98	4	96	CSS100	---
940 II 2.3	B 230 FD	08.94 - 07.95	4	85	CSS100	---
940 II 2.3 ti	B 230 FK	01.95 - 10.98	4	99	CSS100	---
960 2.4 TD Interc.	D24 TIC	09.91 - 07.94	6	85	CSS100	---
960 2.9	B 6304 F	08.90 - 07.94	6	150	CSS100	---
C30 1.6	B 4164 S	10.06 - 12.12	4	74	---	CSS1803
C30 1.6	B 4164 S3	10.06 - 12.12	4	74	CSS1800	CSS1801
C30 1.6 D	D 4164 T	10.06 - 12.12	4	80	CSS1517	---
C30 1.6 D2	D 4162 T	10.10 - 12.12	4	84	CSS1538	---
C30 1.8	B 4184 S11	10.06 - 12.12	4	92	---	CSS1805
C30 1.8 FlexFuel	B 4184 S8	01.07 - 12.12	4	92	---	CSS1805
C30 2.0	B 4204 S3	10.06 - 12.12	4	107	---	CSS1805
C30 2.0 FlexFuel	B 4204 S4	01.10 - 12.12	4	107	CSS1804	CSS1805
S40 I 1.8 i	B 4184 SJ	06.01 - 12.03	4	90	---	CSS1603
S40 I 1.8 i	B 4184 SM	03.98 - 12.03	4	92	---	CSS1603
S40 II 1.6	B 4164 S3	01.05 ->	4	74	CSS1800	CSS1801
S40 II 1.6 D	D 4164 T	01.05 ->	4	81	CSS1517	---
S40 II 1.6 D2	D 4162 T	10.10 ->	4	84	CSS1538	---
S40 II 1.8	B 4184 S11	04.04 ->	4	92	---	CSS1805
S40 II 1.8 FlexFuel	B 4184 S8	01.06 ->	4	92	---	CSS1805
S40 II 2.0	B 4204 S3	10.06 - 12.12	4	107	---	CSS1805
S40 II 2.0 F	B 4204 S4	10.09 - 12.12	4	107	---	CSS720
S60 2.4 D	D 5244 T2	12.01 - 04.10	5	96	---	CSS914

Typ Type	Motornummer Engine-No.	Baujahr Year	Zyl. Cyl.	KW	Kurbelwellen- sensor Crankshaft S.	Nocken- wellensensor Camshaft S.
S60 2.4 D5	D 5244 T	07.01 - 04.10	5	120	---	CSS914
S80 I 2.4 D	D 5244 T2	10.01 - 07.06	5	96	---	CSS914
S80 I 2.4 D5	D 5244 T	08.01 - 07.06	5	120	---	CSS914
S80 II 1.6 D DRIVe	D 4164 T	01.10 ->	4	80	CSS1517	---
S80 II 2.0	B 4204 S3	01.08 ->	4	107	---	CSS720
S80 II 2.0 FlexFuel	B 4204 S4	01.08 ->	4	107	---	CSS1805
V50 1.6	B 4164 S3	01.05 ->	4	74	CSS1800	CSS1801
V50 1.6 D	D 4164 T	01.05 ->	4	81	CSS1517	---
V50 1.8	B 4184 S11	04.04 ->	4	92	---	CSS1805
V50 1.8 FlexFuel	B 4184 S8	01.05 ->	4	92	---	CSS1805
V50 2.0	B 4204 S3	10.06 - 12.12	4	107	---	CSS1805
V50 2.0 FlexFuel	B 4204 S4	01.10 - 12.12	4	107	CSS1804	CSS1805
V70 II 2.4 D	D 5244 T2	12.01 - 08.07	5	96	---	CSS914
V70 II 2.4 D5	D 5244 T, D 5244 T5	08.01 - 08.07	5	120	---	CSS914
V70 III 1.6 D	D 4164 T	01.10 ->	4	80	CSS1517	---
V70 III 2.0 FlexFuel	B 4204 S4	01.08 ->	4	107	---	CSS1805
V70 III 3.2	B 6324 S	08.07 ->	4	175	---	CSS1805
XC90 D5	D 5244 T, D 5244 T5	10.02 ->	5	120	---	CSS914



**CSS100**  
 Passend für / to fit Volvo  
 OME-No. 271949  
 Pol-Anzahl / No. of poles: 3



**CSS200**  
 Passend für / to fit Porsche  
 OEM- No. 996 606 106 02  
 Pol-Anzahl / No. of poles: 3





**CSS300**  
 Passend für / to fit VAG  
 OEM-No. 030 907 601  
 Pol-Anzahl / No. of poles: 3





**CSS301**  
 Passend für / to fit VAG  
 OEM-No. 070 907 601 B  
 Pol-Anzahl / No. of poles: 3





**CSS302**  
 Passend für / to fit VAG  
 OEM-No. 06C 905 163 B  
 Pol-Anzahl / No. of poles: 3





**CSS303**  
 Passend für / to fit VAG  
 OEM-No. 06B 905 163 A  
 Pol-Anzahl / No. of poles: 3

**CSS304**  
 Passend für / to fit VAG  
 OEM-No. 03D 906 433  
 Pol-Anzahl / No. of poles: 3

**CSS306**  
 Passend für / to fit VAG  
 OEM-No. 030 907 601 D  
 Pol-Anzahl / No. of poles: 3



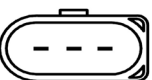

**CSS307**

Passend für / to fit VAG  
OEM-No. 036 907 601 E  
Pol-Anzahl / No. of poles: 3



**CSS308**

Passend für / to fit VAG  
OEM- No. 04C 907 601  
Pol-Anzahl / No. of poles: 3

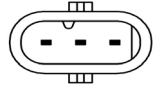

**CSS309**

Passend für / to fit VAG  
OEM-No. 037 906 433 A  
Pol-Anzahl / No. of poles: 3



**CSS310**

Passend für / to fit VAG  
OEM-No. 06A 906 433 F  
Pol-Anzahl / No. of poles: 3

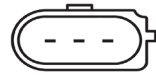

**CSS311**

Passend für / to fit VAG  
OEM-No. 06A 906 433 C  
Pol-Anzahl / No. of poles: 3



**CSS312**

Passend für / to fit VAG  
OEM-No. 078 905 381 A  
Pol-Anzahl / No. of poles: 3

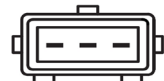

**CSS313**

Passend für / to fit VAG  
OEM- No. 06H 906 433  
Pol-Anzahl / No. of poles: 2



**CSS314**

Passend für / to fit VAG  
OEM-No. 06A 906 433 E  
Pol-Anzahl / No. of poles: 3

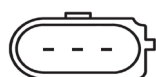



**CSS315**

Passend für / to fit VAG  
OEM-No. 038 907 319  
Pol-Anzahl / No. of poles: 3

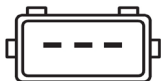

**CSS316**

Passend für / to fit VAG  
OEM-No. 06A 905 161 B  
Pol-Anzahl / No. of poles: 3

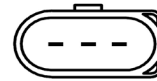

**CSS317**

Passend für / to fit VAG  
OEM-No. 078 905 161 C  
Pol-Anzahl / No. of poles: 3

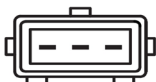

**CSS318**

Passend für / to fit VAG  
OEM-No. 058 905 161 B  
Pol-Anzahl / No. of poles: 3

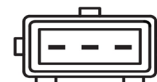

**CSS319**

Passend für / to fit VAG  
OEM-No. 021 907 319 B  
Pol-Anzahl / No. of poles: 3

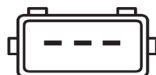

**CSS320**

Passend für / to fit VAG  
OEM-No. 02T 906 207 C  
Pol-Anzahl / No. of poles: 3

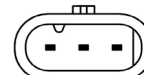

**CSS321**

Passend für / to fit VAG  
OEM-No. 07K 907 601 A  
Pol-Anzahl / No. of poles: 3

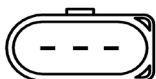

**CSS322**

Passend für / to fit VAG  
OEM-No. 03C 906 433 A  
Pol-Anzahl / No. of poles: 3





**CSS323**

Passend für / to fit VAG  
 OEM- No. 06A 905 161 A  
 Pol-Anzahl / No. of poles: 3





**CSS324**

Passend für / to fit VAG  
 OEM-No. 07L 905 163 C  
 Pol-Anzahl / No. of poles: 3

**CSS325**

Passend für / to fit VAG  
 OEM-No. 06A 906 433 N  
 Pol-Anzahl / No. of poles: 3



**CSS326**

Passend für / to fit VAG  
 OEM-No. 06A 906 433 K  
 Pol-Anzahl / No. of poles: 3



**CSS328**

Passend für / to fit VAG  
 OEM-No. 045 957 147 B  
 Pol-Anzahl / No. of poles: 3



**CSS329**

Passend für / to fit VAG  
 OEM-No. 03G 957 147 B  
 Pol-Anzahl / No. of poles: 3



**CSS330**

Passend für / to fit VAG  
 OEM-No. 03G 957 147 C  
 Pol-Anzahl / No. of poles: 3



**CSS331**

Passend für / to fit VAG  
 OEM- No. 04L 907 601 A  
 Pol-Anzahl / No. of poles: 3





**CSS332**

Passend für / to fit VAG  
 OEM- No. 06E 905 163  
 Pol-Anzahl / No. of poles: 3



**CSS333**

Passend für / to fit VAG  
 OEM- No. 06H 906 207  
 Pol-Anzahl / No. of poles: 3



**CSS400**

Passend für / to fit Mercedes  
 OEM-No. A 003 153 27 28  
 Pol-Anzahl / No. of poles: 2



**CSS401**

Passend für / to fit Mercedes  
 OEM-No. A 003 153 74 28  
 Pol-Anzahl / No. of poles: 1



**CSS402**

Passend für / to fit Mercedes  
 OEM-No. A 004 153 69 28  
 Pol-Anzahl / No. of poles: 3



**CSS403**

Passend für / to fit Mercedes  
 OEM-No. A 272 905 00 43  
 Pol-Anzahl / No. of poles: 3



**CSS404**

Passend für / to fit Mercedes  
 OEM-No. A 004 153 00 28  
 Pol-Anzahl / No. of poles: 3



**CSS405**

Passend für / to fit Mercedes  
 OEM-No. A 642 905 00 00  
 Pol-Anzahl / No. of poles: 3



**New!**



**CSS406**

Passend für / to fit Mercedes  
OEM- No. A 276 905 12 00  
Pol-Anzahl / No. of poles: 3

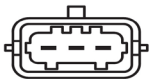

**New!**



**CSS407**

Passend für / to fit Mercedes  
OEM- No. A 003 153 97 28  
Pol-Anzahl / No. of poles: 3

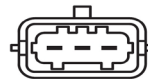

**New!**



**CSS700**

Passend für / to fit Opel  
OEM- No. 25 195 556  
Pol-Anzahl / No. of poles: 3

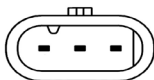

**CSS701**

Passend für / to fit Opel  
OEM-No. 24 445 139  
Pol-Anzahl / No. of poles: 3

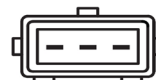

**CSS702**

Passend für / to fit Opel  
OEM-No. 12 38 228  
Pol-Anzahl / No. of poles: 3



**CSS703**

Passend für / to fit Opel  
OEM. No. 62 38 325  
Pol-Anzahl / No. of poles: 3

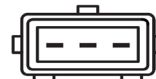

**CSS704**

Passend für / to fit Opel  
OME-No. 62 38 393  
Pol-Anzahl / No. of poles: 3



**CSS705**

Passend für / to fit Opel  
OEM-No. 62 38 098  
Pol-Anzahl / No. of poles: 3



**New!**



**CSS706**

Passend für / to fit Opel  
OEM- No. 55 562 744  
Pol-Anzahl / No. of poles: 3

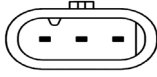

**CSS707**

Passend für / to fit Opel  
OEM-No. 62 38 313  
Pol-Anzahl / No. of poles: 3

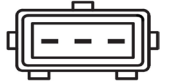

**CSS708**

Passend für / to fit Opel  
OEM-No. 62 38 101  
Pol-Anzahl / No. of poles: 3



**CSS709**

Passend für / to fit Opel  
OEM-No. 62 38 395  
Pol-Anzahl / No. of poles: 3



**CSS710**

Passend für / to fit Opel  
OEM-No. 62 38 459  
Pol-Anzahl / No. of poles: 3

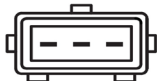

**CSS711**

Passend für / to fit Opel  
OEM-No. 12 38 914  
Pol-Anzahl / No. of poles: 3

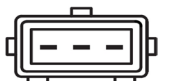

**CSS712**

Passend für / to fit Opel  
OEM-No. 90 12 039  
Pol-Anzahl / No. of poles: 3

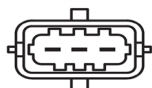

**CSS713**

Passend für / to fit Opel  
OEM-No. 62 38 109  
Pol-Anzahl / No. of poles: 2

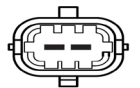



**CSS714**

Passend für / to fit Opel  
OEM-No. 62 38 376  
Pol-Anzahl / No. of poles: 3



**CSS715**

Passend für / to fit Opel  
OEM- No. 25 195 556  
Pol-Anzahl / No. of poles: 3

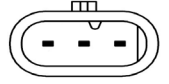

**CSS716**

Passend für / to fit Opel  
OEM-No. 55 216 241  
Pol-Anzahl / No. of poles: 3



**CSS717**

Passend für / to fit Opel  
OEM-No. 62 38 282  
Pol-Anzahl / No. of poles: 3

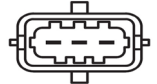

**CSS718**

Passend für / to fit Opel  
OEM-No. 62 38 110  
Pol-Anzahl / No. of poles: 3

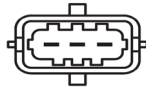

**CSS719**

Passend für / to fit Opel  
OEM- No. 62 38 868  
Pol-Anzahl / No. of poles: 3

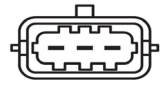

**CSS720**

Passend für / to fit Opel  
OEM- No. 62 35 685  
Pol-Anzahl / No. of poles: 3

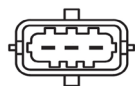

**CSS721**

Passend für / to fit Opel  
OEM- No. 55 565 708  
Pol-Anzahl / No. of poles: 3

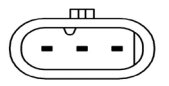





**CSS722**

Passend für / to fit Opel  
 OEM- No. 55 566 932  
 Pol-Anzahl / No. of poles: 3

**CSS900**

Passend für / to fit BMW  
 OEM-No. 12 14 1 703 221  
 Pol-Anzahl / No. of poles: 3

**CSS901**

Passend für / to fit BMW  
 OEM-No. 12 14 1 730 027  
 Pol-Anzahl / No. of poles: 3





**CSS902**

Passend für / to fit BMW  
 OEM-No. 12 14 7 518 628  
 Pol-Anzahl / No. of poles: 2

**CSS903**

Passend für / to fit BMW  
 OEM-No. 12 14 1 703 277  
 Pol-Anzahl / No. of poles: 3

**CSS904**

Passend für / to fit BMW  
 OEM-No. 12 14 7 539 165  
 Pol-Anzahl / No. of poles: 3



**CSS905**

Passend für / to fit BMW  
 OEM-No. 12 14 1 720 858  
 Pol-Anzahl / No. of poles: 3



**CSS906**

Passend für / to fit BMW  
 OEM-No. 12 14 1 726 066  
 Pol-Anzahl / No. of poles: 3





**CSS907**

Passend für / to fit BMW  
OEM-No.  
Pol-Anzahl / No. of poles: 3



**CSS908**

Passend für / to fit BMW  
OEM-No. 12 14 1 720 857  
Pol-Anzahl / No. of poles: 3



**CSS909**

Passend für / to fit BMW  
OEM-No. 12 14 1 729 292  
Pol-Anzahl / No. of poles: 3



**CSS910**

Passend für / to fit BMW  
OEM-No. 12 14 7 539 166  
Pol-Anzahl / No. of poles: 3

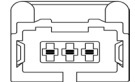

**CSS911**

Passend für / to fit BMW  
OEM-No. 12 14 7 539 169  
Pol-Anzahl / No. of poles: 3

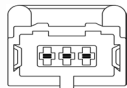

**CSS912**

Passend für / to fit BMW  
OEM-No. 13 62 7 561 753  
Pol-Anzahl / No. of poles: 3

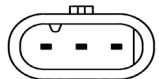

**CSS913**

Passend für / to fit BMW  
OEM-No. 12 14 1 709 616  
Pol-Anzahl / No. of poles: 3

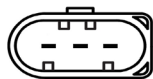

**CSS914**

Passend für / to fit BMW  
OEM-No. 13 62 7 791 127  
Pol-Anzahl / No. of poles: 3

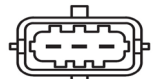



**CSS915**

Passend für / to fit BMW  
OEM-No. 13 62 7 839 138  
Pol-Anzahl / No. of poles: 2



**CSS916**

Passend für / to fit BMW  
OEM-No. 13 62 7 839 138  
Pol-Anzahl / No. of poles: 3

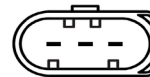

**CSS917**

Passend für / to fit BMW  
OEM-No. 13 62 7 594 047  
Pol-Anzahl / No. of poles: 3

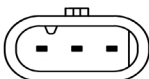

**CSS918**

Passend für / to fit BMW  
OEM-No. 13 62 7 792 256  
Pol-Anzahl / No. of poles: 3

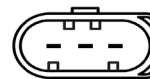

**CSS919**

Passend für / to fit BMW  
OEM-No. 13 62 7 809 334  
Pol-Anzahl / No. of poles: 3

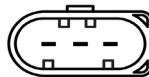

**CSS920**

Passend für / to fit BMW  
OEM-No. 13 62 7 588 095  
Pol-Anzahl / No. of poles: 3

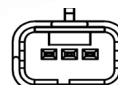

**CSS921**

Passend für / to fit Mini  
OEM- No. 12 14 1 485 845  
Pol-Anzahl / No. of poles: 3



**CSS922**

Passend für / to fit BMW  
OEM- No. 13 62 7 525 014  
Pol-Anzahl / No. of poles: 3

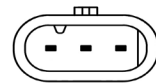



**CSS923**

Passend für / to fit BMW  
 OEM- No. 13 62 7 525 015  
 Pol-Anzahl / No. of poles: 3





**CSS924**

Passend für / to fit BMW  
 OEM- No. 12 14 2 336 620  
 Pol-Anzahl / No. of poles: 3

**CSS1000**

Passend für / to fit Alfa Romeo  
 OEM-No. 46411135  
 Pol-Anzahl / No. of poles: 3



**CSS1300**

Passend für / to fit Alfa Romeo, Fiat, Opel  
 OEM-No. 46798345  
 Pol-Anzahl / No. of poles: 2





**CSS1301**

Passend für / to fit Fiat  
 OEM-No. 55216243  
 Pol-Anzahl / No. of poles: 3





**CSS1303**

Passend für / to fit Fiat  
 OEM-No. 73502752  
 Pol-Anzahl / No. of poles: 2

**CSS1304**

Passend für / to fit Fiat  
 OEM-No. 55189515  
 Pol-Anzahl / No. of poles: 3



**CSS1305**

Passend für / to fit Fiat  
 OEM-No. 55189517  
 Pol-Anzahl / No. of poles: 3





**CSS1306**

Passend für / to fit Fiat  
OEM-No. 7672023  
Pol-Anzahl / No. of poles: 3



**CSS1307**

Passend für / to fit Fiat  
OEM-No. 7766251  
Pol-Anzahl / No. of poles: 3

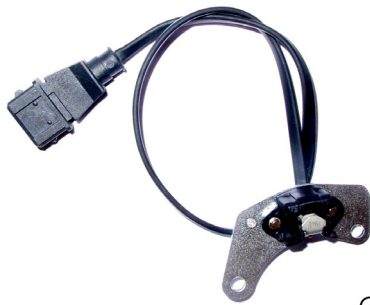

**CSS1308**

Passend für / to fit Fiat  
OEM-No. 46481306  
Pol-Anzahl / No. of poles: 3

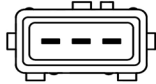

**CSS1309**

Passend für / to fit Fiat  
OEM-No. 46806128  
Pol-Anzahl / No. of poles: 3

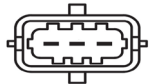

**CSS1310**

Passend für / to fit Fiat  
OEM-No. 55189514  
Pol-Anzahl / No. of poles: 3



**CSS1317**

Passend für / to fit Fiat  
OEM-No. 46798352  
Pol-Anzahl / No. of poles: 2



**CSS1318**

Passend für / to fit Fiat  
OEM-No. 55267144  
Pol-Anzahl / No. of poles: 2



**CSS1321**

Passend für / to fit Fiat  
OEM-No. 55222989  
Pol-Anzahl / No. of poles: 3

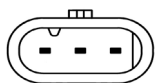



**CSS1322**

Passend für / to fit Fiat  
OEM-No. 55216242  
Pol-Anzahl / No. of poles: 3



**CSS1401**

Passend für / to fit Chevrolet  
OEM- No. 96 325 867  
Pol-Anzahl / No. of poles: 3



**CSS1402**

Passend für / to fit Chevrolet  
OEM- No. 96 325 868  
Pol-Anzahl / No. of poles: 3

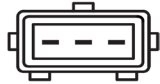

**CSS1500**

Passend für / to fit Citroën, Fiat, Lancia, Peugeot  
OEM-No. 96 068 16880  
Pol-Anzahl / No. of poles: 3

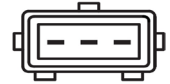

**CSS1501**

Passend für / to fit Citroën, Peugeot, Renault  
OEM-No. 1920 F5  
Pol-Anzahl / No. of poles: 3



**CSS1502**

Passend für / to fit Citroën, Peugeot  
OEM-No. 1920 Z3  
Pol-Anzahl / No. of poles: 3

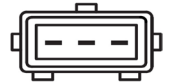

**CSS1503**

Passend für / to fit Citroën, Peugeot  
OEM-No. 1920 L1  
Pol-Anzahl / No. of poles: 3



**CSS1504**

Passend für / to fit Citroën, Peugeot  
OEM-No. 5918 94  
Pol-Anzahl / No. of poles: 3





**CSS1505**

Passend für / to fit Citroën, Peugeot  
OEM-No. 5918 93

Pol-Anzahl / No. of poles: 3



**CSS1506**

Passend für / to fit Citroën, Fiat, Peugeot  
OEM-No. 1920 C3

Pol-Anzahl / No. of poles: 3



**CSS1507**

Passend für / to fit Citroën, Peugeot  
OEM-No. 96 085 17080

Pol-Anzahl / No. of poles: 3



**CSS1508**

Passend für / to fit Citroën, Peugeot  
OEM-No. 1920 5T

Pol-Anzahl / No. of poles: 2

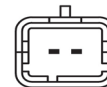

**CSS1509**

Passend für / to fit Citroën, Peugeot  
OEM-No. 1920 6T

Pol-Anzahl / No. of poles: 3



**CSS1510**

Passend für / to fit Citroën, Peugeot  
OEM-No. 1920 QN

Pol-Anzahl / No. of poles: 3

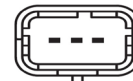

**CSS1511**

Passend für / to fit Citroën, Peugeot, Renault  
OEM-No. 1920 8W

Pol-Anzahl / No. of poles: 3

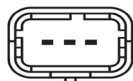

**CSS1512**

Passend für / to fit Citroën, Peugeot  
OEM-No. 1920 AE

Pol-Anzahl / No. of poles: 3

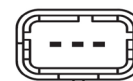



**CSS1513**

Passend für / to fit Citroën, Peugeot, Renault  
OEM-No. 96 324 005 80  
Pol-Anzahl / No. of poles: 2

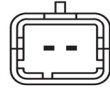

**CSS1514**

Passend für / to fit Citroën, Peugeot, Renault  
OEM-No. 96 328 89780  
Pol-Anzahl / No. of poles: 2

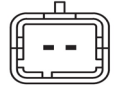

**CSS1515**

Passend für / to fit Citroën, Peugeot, Renault  
OEM-No. 96 334 75780  
Pol-Anzahl / No. of poles: 2

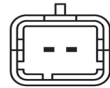

**CSS1516**

Passend für / to fit Citroën, Fiat, Lancia, Peugeot, Renault  
OEM-No. 1920 9C  
Pol-Anzahl / No. of poles: 2

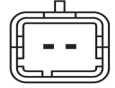

**CSS1517**

Passend für / to fit Citroën, Peugeot  
OEM-No. 1920 EH  
Pol-Anzahl / No. of poles: 3

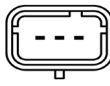

**CSS1518**

Passend für / to fit Citroën, Peugeot, Renault  
OEM-No. 1920 AW  
Pol-Anzahl / No. of poles: 2

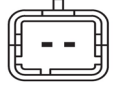

**CSS1519**

Passend für / to fit Citroën, Peugeot  
OEM-No. 1920 EJ  
Pol-Anzahl / No. of poles: 2

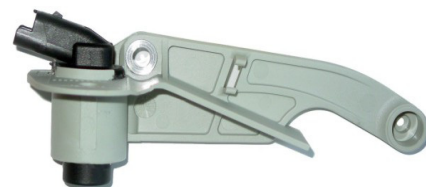
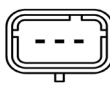

**CSS1520**

Passend für / to fit Citroën, Peugeot  
OEM-No. 1920 5V  
Pol-Anzahl / No. of poles: 2

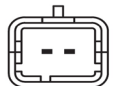



**CSS1521**

Passend für / to fit Peugeot  
OEM-No. 1920 AV  
Pol-Anzahl / No. of poles: 2

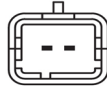

**CSS1522**

Passend für / to fit Fiat, Lancia, Peugeot  
OEM-No. 1920 FP  
Pol-Anzahl / No. of poles: 3

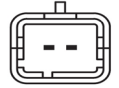

**CSS1525**

Passend für / to fit Renault  
OEM-No. 77 00 739 787  
Pol-Anzahl / No. of poles: 2

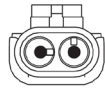

**CSS1526**

Passend für / to fit Renault  
OEM-No. 77 00 739 792  
Pol-Anzahl / No. of poles: 2



**CSS1527**

Passend für / to fit Renault  
OEM-No. 77 00 739 794  
Pol-Anzahl / No. of poles: 2

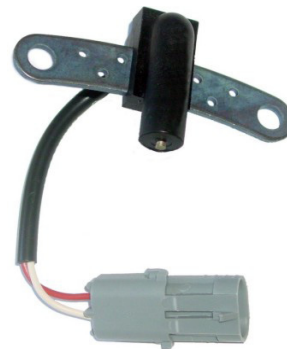
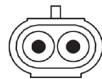

**CSS1528**

Passend für / to fit Mitsubishi  
OEM-No. 77 00 859 831  
Pol-Anzahl / No. of poles: 2



**CSS1529**

Passend für / to fit Renault  
OEM-No. 77 00 728 638  
Pol-Anzahl / No. of poles: 2



**CSS1523**

Passend für / to fit Renault, Volvo  
OEM-No. 77 00 739 591  
Pol-Anzahl / No. of poles: 2





**CSS1524**

Passend für / to fit Renault  
OEM-No. 77 00 722 143  
Pol-Anzahl / No. of poles: 3



**CSS1530**

Passend für / to fit Renault  
OEM-No. 82 00 038 472  
Pol-Anzahl / No. of poles: 3



**CSS1531**

Passend für / to fit Renault  
OEM-No. 60 25 403 357  
Pol-Anzahl / No. of poles: 2

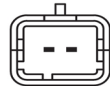

**CSS1532**

Passend für / to fit Renault  
OEM-No. 82 00 643 171  
Pol-Anzahl / No. of poles: 2

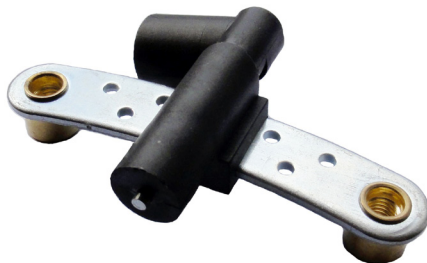
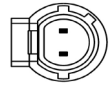

**CSS1533**

Passend für / to fit Renault  
OEM-No. 77 00 273 419A  
Pol-Anzahl / No. of poles: 2

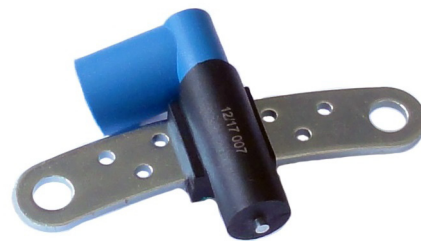
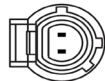

**CSS1534**

Passend für / to fit Renault  
OEM-No. 82 00 647 554  
Pol-Anzahl / No. of poles: 2

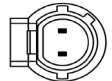

**CSS1535**

Passend für / to fit Renault  
OEM-No. 77 00 108 081  
Pol-Anzahl / No. of poles: 2

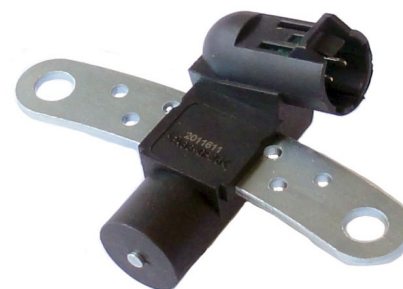

**CSS1536**

Passend für / to fit Dacia, Renault  
OEM-No. 82 00 439 315  
Pol-Anzahl / No. of poles: 2





**CSS1537**

Passend für / to fit Dacia, Renault  
OEM-No. 82 00 885 209  
Pol-Anzahl / No. of poles: 2



**CSS1538**

Passend für / to fit Peugeot  
OEM-No. 1920 PW  
Pol-Anzahl / No. of poles: 3

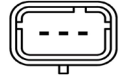

**CSS1539**

Passend für / to fit Citroën, Fiat, Honda, Peugeot  
OEM-No. 1920 QS  
Pol-Anzahl / No. of poles: 3

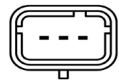

**CSS1540**

Passend für / to fit Dacia, Renault  
OEM-No. 82 00 285 798  
Pol-Anzahl / No. of poles: 3



**CSS1541**

Passend für / to fit Dacia, Renault  
OEM-No. 82 00 691 795  
Pol-Anzahl / No. of poles: 2

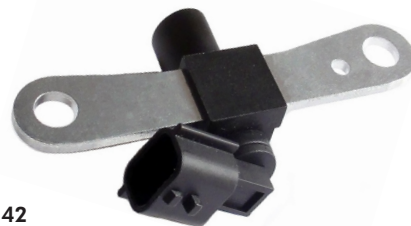
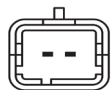

**CSS1542**

Passend für / to fit Dacia, Renault  
OEM-No. 82 00 746 497  
Pol-Anzahl / No. of poles: 2

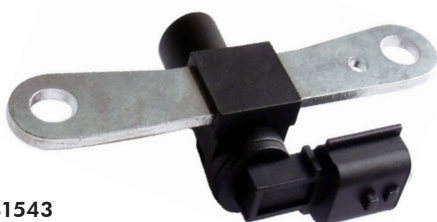
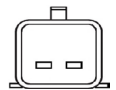

**CSS1543**

Passend für / to fit Dacia, Renault  
OEM-No. 82 00 772 182  
Pol-Anzahl / No. of poles: 2

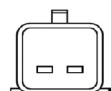

**CSS1545**

Passend für / to fit Citroën, Peugeot  
OEM- No. 96 773 087 80  
Pol-Anzahl / No. of poles: 3

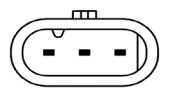



**CSS1546**

Passend für / to fit Citroën, Peugeot  
 OEM- No. 96 742 659 80  
 Pol-Anzahl / No. of poles: 3





**CSS1547**

Passend für / to fit Citroën, Peugeot  
 OEM- No. 96 775 394 80  
 Pol-Anzahl / No. of poles: 3





**CSS1548**

Passend für / to fit Citroën, Peugeot  
 OEM- No. 96 752 267 80  
 Pol-Anzahl / No. of poles: 3

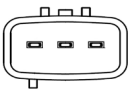

**CSS1600**

Passend für / to fit Hyundai  
 OEM-No. 39350-25010  
 Pol-Anzahl / No. of poles: 3

**CSS1601**

Passend für / to fit Hyundai  
 OEM-No. 39180-23910  
 Pol-Anzahl / No. of poles: 3

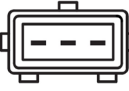
**CSS1602**

Passend für / to fit Hyundai  
 OEM-No. 39180-27000  
 Pol-Anzahl / No. of poles: 3

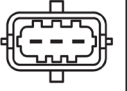

**CSS1603**

Passend für / to fit Hyundai  
 OEM-No. 39310-38050  
 Pol-Anzahl / No. of poles: 3



**CSS1604**

Passend für / to fit Hyundai  
 OEM-No. 23731-6J90C  
 Pol-Anzahl / No. of poles: 3







**CSS1605**

Passend für / to fit Hyundai  
 OEM- No. 39180-2B020  
 Pol-Anzahl / No. of poles: 3

**CSS1700**

Passend für / to fit Hyundai  
 OEM-No. 39180-22600  
 Pol-Anzahl / No. of poles: 2

**CSS1701**

Passend für / to fit Hyundai  
 OEM-No. 39180-22040  
 Pol-Anzahl / No. of poles: 3





**CSS1703**

Passend für / to fit Mazda  
 OEM-No. 6M8G-6C315  
 Pol-Anzahl / No. of poles: 3



**CSS1800**

Passend für / to fit Ford  
 OEM-No. 1 110 834  
 Pol-Anzahl / No. of poles: 2



**CSS1801**

Passend für / to fit Ford  
 OEM-No. 1 111 037  
 Pol-Anzahl / No. of poles: 2

**CSS1802**

Passend für / to fit Ford, Mazda  
 OEM-No. 1 367 334  
 Pol-Anzahl / No. of poles: 3

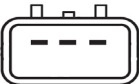
**CSS1803**

Passend für / to fit Ford  
 OEM-No. 1 685 719  
 Pol-Anzahl / No. of poles: 3





**CSS1804**

Passend für / to fit Ford  
OEM-No. 1 129 988  
Pol-Anzahl / No. of poles: 2



**CSS1805**

Passend für / to fit Ford  
OEM-No. 1S7F-12K073-AD  
Pol-Anzahl / No. of poles: 2

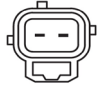

**CSS1806**

Passend für / to fit Ford  
OEM-No. 1 781 666  
Pol-Anzahl / No. of poles: 3

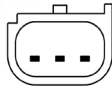

**CSS1807**

Passend für / to fit Ford  
OEM-No. 1 087 548  
Pol-Anzahl / No. of poles: 3

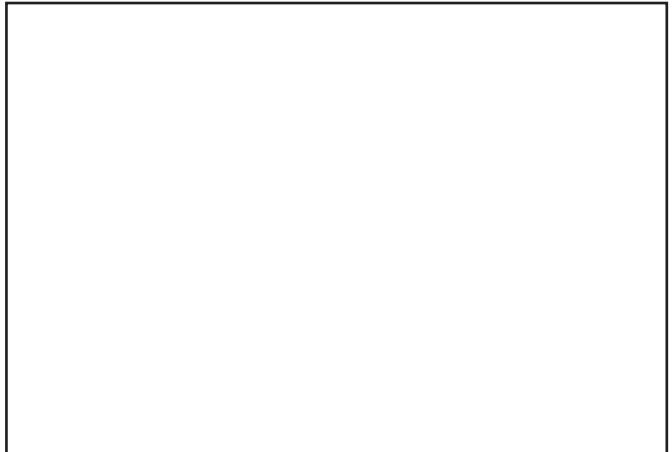
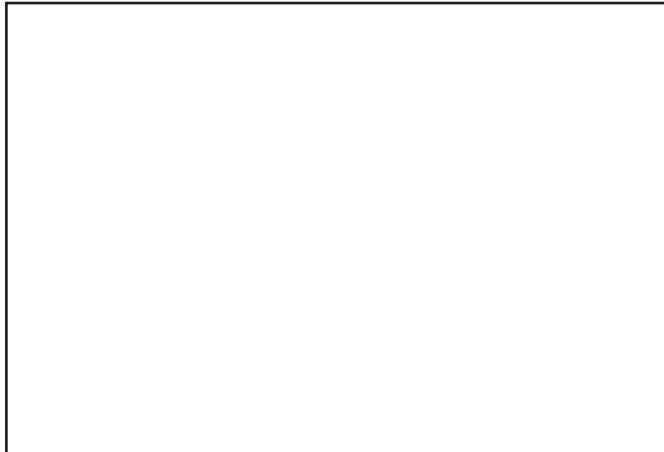

# VERGLEICHSLISTE / CROSS REFERENCE LIST

Referenz-Nr. Reference-No.	BBT-Nr. BBT-No.
-------------------------------	--------------------

<b>Alfa Romeo</b>	<b>BBT</b>
46411135	CSS1000
46411138	CSS1000
46798345	CSS1300
46798364	CSS1301
55187973	CSS720
55201876	CSS1301
55216243	CSS1301
60523246	CSS1306
60800100	CSS1306

<b>BMW</b>	<b>BBT</b>
------------	------------

12 14 0 148 889	CSS924
12 14 1 247 218	CSS907
12 14 1 435 350	CSS904
12 14 1 435 352	CSS910
12 14 1 438 081	CSS904
12 14 1 438 082	CSS902
12 14 1 438 083	CSS910
12 14 1 703 221	CSS900
12 14 1 703 277	CSS903
12 14 1 713 007	CSS905
12 14 1 714 763	CSS908
12 14 1 720 852	CSS905
12 14 1 720 853	CSS908
12 14 1 720 857	CSS908
12 14 1 720 858	CSS905
12 14 1 726 065	CSS906
12 14 1 726 066	CSS906
12 14 1 729 292	CSS909
12 14 1 730 027	CSS901
12 14 1 731 887	CSS909
12 14 1 742 185	CSS910
12 14 1 742 629	CSS915
12 14 2 286 181	CSS924
12 14 2 286 182	CSS924
12 14 2 295 386	CSS924
12 14 2 336 620	CSS924
12 14 7 503 140	CSS924
12 14 7 506 273	CSS902
12 14 7 516 056	CSS911
12 14 7 518 628	CSS902
12 14 7 539 165	CSS904
12 14 7 539 166	CSS910
12 14 7 539 169	CSS911
13 62 7 525 014	CSS922
13 62 7 525 015	CSS923
13 62 7 546 660	CSS922
13 62 7 548 660	CSS917
13 62 7 548 994	CSS924
13 62 7 558 518	CSS922
13 62 7 561 753	CSS912
13 62 7 566 052	CSS920
13 62 7 570 191	CSS920
13 62 7 588 095	CSS920

Referenz-Nr. Reference-No.	BBT-Nr. BBT-No.
-------------------------------	--------------------

13 62 7 594 047	CSS917
13 62 7 633 958	CSS922
13 62 7 639 278	CSS924
13 62 7 787 192	CSS919
13 62 7 791 127	CSS914
13 62 7 792 256	CSS918
13 62 7 794 646	CSS916
13 62 7 809 334	CSS919
13 62 7 839 138	CSS915
75 61 7 538 001	CSS912

<b>Bosch</b>	<b>BBT</b>
--------------	------------

0 232 101 024	CSS318
0 232 101 027	CSS317
0 232 101 031	CSS316
0 232 103 019	CSS323
0 232 103 021	CSS718
0 232 103 022	CSS200
0 232 103 037	CSS402
0 232 103 052	CSS720
0 232 103 064	CSS920
0 232 103 114	CSS403
0 261 210 030	CSS707
0 261 210 048	CSS706
0 261 210 114	CSS1305
0 261 210 124	CSS1305
0 261 210 129	CSS1000
0 261 210 137	CSS1528
0 261 210 146	CSS314
0 261 210 147	CSS311
0 261 210 148	CSS311
0 261 210 151	CSS713
0 261 210 151	CSS713
0 261 210 165	CSS310
0 261 210 170	CSS400
0 261 210 199	CSS325
0 281 002 102	CSS1307
0 281 002 123	CSS401
0 281 002 285	CSS708
0 281 002 474	CSS1309
0 281 002 477	CSS919
0 281 002 603	CSS1317
0 281 022 138	CSS709
0 986 280 401	CSS100
0 986 280 402	CSS1500
0 986 280 402	CSS1506
0 986 280 403	CSS1526
0 986 280 405	CSS1527
0 986 280 406	CSS1502
0 986 280 407	CSS1528
0 986 280 408	CSS1518
0 986 280 409	CSS1508
0 986 280 410	CSS1534
0 986 280 411	CSS1532
0 986 280 412	CSS1530

Referenz-Nr. Reference-No.	BBT-Nr. BBT-No.
-------------------------------	--------------------

0 986 280 413	CSS1510
0 986 280 414	CSS1516
0 986 280 415	CSS1504
0 986 280 416	CSS1513
0 986 280 417	CSS1515
0 986 280 418	CSS300
0 986 280 419	CSS1517
0 986 280 420	CSS307
0 986 280 421	CSS308
0 986 280 422	CSS304
0 986 280 424	CSS1303
0 986 280 427	CSS1519
0 986 280 428	CSS302
0 986 280 429	CSS303
0 986 280 431	CSS332
0 986 280 433	CSS1540
0 986 280 434	CSS322

<b>Citroën</b>	<b>BBT</b>
----------------	------------

1920 4A	CSS1502
1920 5T	CSS1508
1920 5V	CSS1520
1920 6T	CSS1509
1920 7N	CSS1513
1920 7P	CSS1515
1920 7V	CSS1510
1920 8S	CSS1514
1920 8W	CSS1511
1920 9C	CSS1516
1920 AE	CSS1512
1920 AV	CSS1521
1920 AW	CSS1518
1920 C3	CSS1500
1920 EH	CSS1517
1920 EJ	CSS1519
1920 EN	CSS1522
1920 F5	CSS1501
1920 FP	CSS1522
1920 J5	CSS1502
1920 LR	CSS912
1920 LS	CSS920
1920 QS	CSS1539
1920 W9	CSS1506
1920 Z3	CSS1502
5918 81	CSS1501
5918 87	CSS1501
5918 90	CSS1501
5918 93	CSS1505
5918 94	CSS1504
5940 09	CSS1310
91 541 075	CSS1500
96 037 097	CSS1501
96 067 317	CSS1501
96 067 317 80	CSS1501
96 068 168	CSS1500

# VERGLEICHSLISTE / CROSS REFERENCE LIST

Referenz-Nr. Reference-No.	BBT-Nr. BBT-No.	Referenz-Nr. Reference-No.	BBT-Nr. BBT-No.	Referenz-Nr. Reference-No.	BBT-Nr. BBT-No.
96 068 168 80	CSS1501	82 00 885 209	CSS1537	550011	CSS1513
96 068 172	CSS1501			550012	CSS1515
96 068 172 80	CSS1501	<b>Delphi</b>	<b>BBT</b>	550013	CSS1516
96 085 170	CSS1502	SS10152	CSS1701	550014	CSS1517
96 131 733	CSS1503	SS10725	CSS1300	550015	CSS1518
96 222 098	CSS1501	SS10726	CSS1301	550016	CSS1521
96 222 098 80	CSS1501	SS10727	CSS716	550017	CSS1519
96 222 624 80	CSS1507	SS10728	CSS1303	550018	CSS1522
96 285 598 80	CSS1510	SS10732	CSS1500	550020	CSS1806
96 285 599 80	CSS1510	SS10735	CSS1504	550021	CSS1527
96 291 398 80	CSS1511	SS10736	CSS1506	550022	CSS1528
96 296 843 80	CSS1509	SS10737	CSS1520	550023	CSS1529
96 305 956 80	CSS1511	SS10738	CSS1509	550024	CSS1532
96 324 005 80	CSS1513	SS10739	CSS1510	550026	CSS301
96 328 897 80	CSS1514	SS10740	CSS1511	550027	CSS302
96 334 757 80	CSS1515	SS10741	CSS1512	550028	CSS303
96 346 055 80	CSS1512	SS10743	CSS1513	550029	CSS304
96 346 059 80	CSS1512	SS10744	CSS1515	550032	CSS306
96 357 329 80	CSS1516	SS10745	CSS1516	550033	CSS307
96 372 208 80	CSS1517	SS10746	CSS1517	550039	CSS1804
96 374 659 80	CSS1518	SS10747	CSS1518	550040	CSS1805
96 374 660 80	CSS1521	SS10748	CSS1521	550046	CSS1540
96 374 669 80	CSS1517	SS10749	CSS1519	550055	CSS1309
96 374 991 80	CSS1519	SS10750	CSS1522	550057	CSS1307
96 399 998 80	CSS1518	SS10753	CSS1523	550058	CSS1536
96 399 999	CSS1521	SS10755	CSS1525	550060	CSS701
96 399 999 80	CSS1521	SS10757	CSS1527	550061	CSS713
96 406 277 80	CSS1522	SS10758	CSS1528	550063	CSS708
96 468 233 80	CSS1522	SS10762	CSS302	550064	CSS1305
96 605 820 80	CSS1519	SS10763	CSS303	550065	CSS1701
96 643 873 80	CSS1538	SS10765	CSS304	550066	CSS1533
96 647 321 80	CSS1539	SS10766	CSS306	550067	CSS1304
96 742 659 80	CSS1546	SS10770	CSS332	550068	CSS707
96 752 267 80	CSS1548	SS10773	CSS300	550071	CSS1306
96 773 087 80	CSS1545	SS10787	CSS100	550072	CSS1535
96 775 394 80	CSS1547	SS10953	CSS721	550073	CSS702
98 009 914 80	CSS1545	SS10982	CSS915	550074	CSS1310
V7 550 79880	CSS920	SS11007	CSS407	550076	CSS711
V7 566 05280	CSS920	SS11055	CSS1402	550077	CSS704
V7 570 19180	CSS920	SS11074	CSS924	550078	CSS710
V7 588 09580	CSS920	SS11123	CSS922	550088	CSS900
		SS11156	CSS912	550094	CSS1308
				550105	CSS313
<b>Chevrolet</b>	<b>BBT</b>			550108	CSS309
96 325 867	CSS1401	<b>ERA</b>	<b>BBT</b>	550109	CSS311
96 325 868	CSS1402	550000	CSS1300	550110	CSS1800
		550001	CSS1301	550111	CSS1801
<b>Chrysler</b>	<b>BBT</b>	550002	CSS716	550115	CSS1503
5080346 AA	CSS407	550003	CSS1303	550116	CSS1509
90 520 854	CSS705	550004	CSS1500	550117	CSS1510
		550005	CSS1502	550118	CSS1512
<b>Dacia</b>	<b>BBT</b>	550006	CSS1506	550120	CSS300
60 01 545 512	CSS1536	550007	CSS1507	550123	CSS325
60 01 548 175	CSS1532	550008	CSS1508	550126	CSS716
82 00 436 025	CSS1532	550009	CSS1520	550128	CSS914
82 00 746 497	CSS1542	550010	CSS1511		

# VERGLEICHSLISTE / CROSS REFERENCE LIST

Referenz-Nr. Reference-No.	BBT-Nr. BBT-No.
-------------------------------	--------------------

550129	CSS705
550156	CSS1000
550168	CSS1700
550176	CSS1514
550182	CSS100
550186	CSS1504
550187	CSS1505
550189	CSS332
550192	CSS709
550210	CSS903
550214	CSS913
550218	CSS901
550232	CSS326
550243	CSS317
550254	CSS328
550255	CSS319
550268	CSS1317
550272	CSS919
550275	CSS400
550289	CSS1807
550292	CSS720
550329	CSS1603
550355	CSS1601
550370	CSS1318
550401	CSS1401
550402	CSS1402
550408	CSS1602
550428	CSS1802
550470	CSS912
550471	CSS1538
550473	CSS1539
550476	CSS324
550478	CSS321
550479	CSS322
550480	CSS320
550508	CSS404
550509	CSS407
550556	CSS1600
550603	CSS923
550604	CSS922
550613	CSS722
550626	CSS1543
550628	CSS1322
550629	CSS1321
550631	CSS1537
550636	CSS333
550648	CSS717
550688	CSS323
550730	CSS721
550731	CSS715
550738	CSS706
550785	CSS1542
550830	CSS719
551238	CSS700
551262	CSS924

Referenz-Nr. Reference-No.	BBT-Nr. BBT-No.
-------------------------------	--------------------

551391	CSS916
551393	CSS405
551427	CSS1547
552116	CSS1605
554640	CSS1803
<b>Facet</b>	<b>BBT</b>
9.0005	CSS1306
9.0010	CSS1526
9.0016	CSS1527
9.0021	CSS1500
9.0021	CSS1506
9.0026	CSS1524
9.0044	CSS1501
9.0053	CSS1305
9.0056	CSS909
9.0064	CSS905
9.0065	CSS908
9.0066	CSS312
9.0066	CSS313
9.0073	CSS707
9.0082	CSS309
9.0087	CSS907
9.0105	CSS1503
9.0127	CSS1502
9.0127	CSS1507
9.0130	CSS906
9.0137	CSS704
9.0149	CSS703
9.0155	CSS1000
9.0157	CSS1304
9.0160	CSS709
9.0164	CSS714
9.0172	CSS311
9.0176	CSS1520
9.0177	CSS1508
9.0178	CSS1509
9.0187	CSS1701
9.0194	CSS1533
9.0197	CSS1535
9.0213	CSS1308
9.0219	CSS315
9.0235	CSS713
9.0236	CSS710
9.0237	CSS708
9.0238	CSS705
9.0254	CSS326
9.0258	CSS1516
9.0260	CSS1513
9.0269	CSS301
9.0269	CSS307
9.0273	CSS319
9.0279	CSS1700
9.0281	CSS1805
9.0293	CSS1522

Referenz-Nr. Reference-No.	BBT-Nr. BBT-No.
-------------------------------	--------------------

9.0298	CSS1518
9.0299	CSS1521
9.0303	CSS1514
9.0305	CSS1515
9.0314	CSS702
9.0319	CSS1531
9.0333	CSS1804
9.0335	CSS1603
9.0337	CSS716
9.0344	CSS914
9.0346	CSS718
9.0348	CSS1540
9.0351	CSS323
9.0355	CSS1307
9.0361	CSS720
9.0365	CSS318
9.0367	CSS316
9.0368	CSS300
9.0368	CSS306
9.0378	CSS1318
9.0379	CSS1317
9.0380	CSS716
9.0381	CSS1310
9.0387	CSS403
9.0388	CSS1301
9.0397	CSS100
9.0398	CSS310
9.0398	CSS314
9.0401	CSS317
9.0407	CSS1303
9.0423	CSS328
9.0438	CSS200
9.0438	CSS402
9.0440	CSS1300
9.0449	CSS717
9.0456	CSS330
9.0459	CSS407
9.0473	CSS924
9.0481	CSS1807
9.0485	CSS905
9.0514	CSS324
9.0523	CSS922
9.0535	CSS329
9.0598	CSS322
9.0602	CSS1538
9.0640	CSS313
9.0645	CSS1537
9.0654	CSS405
9.0658	CSS1542
9.0659	CSS1543
9.0683	CSS304
9.0793	CSS308
9.0199K	CSS1536
9.0540K	CSS1532
9.0543K	CSS1534

# VERGLEICHSLISTE / CROSS REFERENCE LIST

Referenz-Nr. Reference-No.	BBT-Nr. BBT-No.	Referenz-Nr. Reference-No.	BBT-Nr. BBT-No.	Referenz-Nr. Reference-No.	BBT-Nr. BBT-No.
<b>Febi</b>	<b>BBT</b>				
18163	CSS702	44787	CSS1803	1 079 388	CSS1807
21071	CSS903	44900	CSS1802	1 085 854	CSS1807
22891	CSS1532	79246	CSS1806	1 087 548	CSS1807
22901	CSS1527			1 100 748	CSS328
22901	CSS1529	<b>Fiat</b>	<b>BBT</b>	1 110 834	CSS1800
22903	CSS1534	1581176	CSS716	1 111 037	CSS1801
23799	CSS902	4460206	CSS1306	1 112 988	CSS1804
23931	CSS915	7547714	CSS1306	1 119 150	CSS1804
24162	CSS904	7760493	CSS1308	1 119 942	CSS1805
24444	CSS311	7766251	CSS1307	1 132 377	CSS1806
24455	CSS400	7777960	CSS1305	1 148 056	CSS1519
24508	CSS309	7798691	CSS1305	1 148 073	CSS1517
24576	CSS315	46411138	CSS1000	1 219 768	CSS1806
24613	CSS900	46440840	CSS1308	1 222 677	CSS914
24616	CSS713	46442091	CSS1304	1 253 755	CSS328
26335	CSS1513	46454057	CSS1308	1 319 158	CSS720
26513	CSS1805	46462120	CSS1308	1 355 063	CSS1806
27175	CSS703	46479975	CSS1304	1 367 334	CSS1802
27177	CSS707	46481306	CSS1308	1 473 035	CSS1800
27321	CSS906	46778331	CSS1310	1 517 990	CSS1538
28102	CSS705	46786049	CSS914	1 535 716	CSS1318
28119	CSS1303	46798345	CSS1300	1 564 811	CSS1318
28126	CSS1300	46798352	CSS1317	1 564 860	CSS1303
28127	CSS717	46798364	CSS1301	1 639 282	CSS1306
28129	CSS716	46798365	CSS716	1 685 719	CSS1803
28130	CSS1301	46806128	CSS1309	1 756 079	CSS1803
28131	CSS914	55187332	CSS1304	1 756 079	CSS1801
29481	CSS918	55187380	CSS1318	1 781 666	CSS1806
29483	CSS924	55189514	CSS1310	1 801 925	CSS1800
29547	CSS402	55189515	CSS1304	1 826 557	CSS720
31088	CSS912	55201874	CSS1301	1 830 151	CSS1803
31190	CSS1538	55201876	CSS1301	1 830 151	CSS1801
31242	CSS1539	55201876	CSS1301	5 114 675	CSS1800
31700	CSS916	55206561	CSS1322	1S4F-12K073 AA	CSS1806
32034	CSS323	55216242	CSS1322	1S4F-12K073 BA	CSS1806
32317	CSS407	55216243	CSS1301	1S7F-12K073-AD	CSS1805
32575	CSS1603	55216243	CSS1301	1S7F-6C315-AD	CSS1804
33123	CSS1402	55222989	CSS1321	1S7F-GC315-AD	CSS1804
33124	CSS1401	55229700	CSS1318	2S6Q-9E731-AA	CSS1517
33737	CSS404	60523246	CSS1306	3M21-6B288-AA	CSS328
34382	CSS922	60800100	CSS1306	4M5G1-2K073-AA	CSS720
36115	CSS329	60808213	CSS1306	5M51-12K073 AA	CSS1806
36176	CSS313	60816553	CSS1309	6M8G-12K073-AB	CSS1802
36406	CSS917	73502752	CSS1303	6M8G-6C-315	CSS1703
37333	CSS1807	77662510	CSS1307	8S6Q-9E731-AA	CSS1538
38710	CSS722	468061280	CSS1309	95VW 9P986 BA	CSS323
38711	CSS700	9606816880	CSS1500	98AB-9E731 AA	CSS1807
39605	CSS706	9622209880	CSS1506	98AB-9E731 AC	CSS1807
39811	CSS715	9632400580	CSS1513	98AB-9E731 AD	CSS1807
39867	CSS326	9635732980	CSS1516	98AB-9E731 AF	CSS1807
39894	CSS330			98AB-9E731 AG	CSS1807
40772	CSS720	<b>Ford</b>	<b>BBT</b>	9S51-9E731-BA	CSS1318
44383	CSS332	1 062 545	CSS1807	BE8Z6-B288A	CSS720
		1 066 383	CSS1807	BM51-12K073-AA	CSS1803
		1 072 303	CSS323	BM51-12K073-AC	CSS1803

# VERGLEICHSLISTE / CROSS REFERENCE LIST

Referenz-Nr. Reference-No.	BBT-Nr. BBT-No.
-------------------------------	--------------------

XM21-6B288-AA	CSS328
YS6A-12K073-AB	CSS1801
YS6A-6C315-AB	CSS1800

<b>GM</b>	<b>BBT</b>
-----------	------------

09 110 560	CSS1534
55 567 243	CSS719
55 187 973	CSS720
90 12 039	CSS712
90 213 515	CSS707
90 357 491	CSS703
90 404 188	CSS709
90 450 188	CSS709
90 458 252	CSS701
90 483 739	CSS704
90 485 251	CSS711
90 493 864	CSS714
90 506 130	CSS702
90 520 854	CSS705
90 520 856	CSS710
91 18 368	CSS713
91 74 621	CSS702
93 171 450	CSS712
93 178 045	CSS1303
93 178 046	CSS716
93 179 391	CSS1300
93 179 392	CSS1301
93 179 433	CSS1317
93 183 528	CSS720
97 180 388	CSS716

<b>Hella</b>	<b>BBT</b>
--------------	------------

6PU 009 110-001	CSS903
6PU 009 110-111	CSS1527
6PU 009 110-171	CSS1528
6PU 009 110-221	CSS704
6PU 009 110-251	CSS1506
6PU 009 110-251	CSS1500
6PU 009 110-271	CSS702
6PU 009 110-281	CSS309
6PU 009 110-401	CSS1532
6PU 009 110-421	CSS913
6PU 009 110-501	CSS400
6PU 009 110-511	CSS905
6PU 009 110-531	CSS908
6PU 009 110-541	CSS906
6PU 009 110-561	CSS907
6PU 009 110-621	CSS711
6PU 009 110-641	CSS710
6PU 009 110-651	CSS714
6PU 009 110-681	CSS705
6PU 009 110-701	CSS1533
6PU 009 110-721	CSS1535
6PU 009 121-011	CSS922
6PU 009 121-051	CSS900

Referenz-Nr. Reference-No.	BBT-Nr. BBT-No.
-------------------------------	--------------------

6PU 009 121-061	CSS701
6PU 009 121-071	CSS404
6PU 009 121-201	CSS1503
6PU 009 121-221	CSS713
6PU 009 121-311	CSS712
6PU 009 121-321	CSS1301
6PU 009 121-331	CSS716
6PU 009 121-341	CSS1509
6PU 009 121-351	CSS1510
6PU 009 121-361	CSS1511
6PU 009 121-371	CSS1512
6PU 009 121-381	CSS1519
6PU 009 121-391	CSS1530
6PU 009 121-401	CSS301
6PU 009 121-401	CSS307
6PU 009 121-411	CSS302
6PU 009 121-421	CSS303
6PU 009 121-441	CSS306
6PU 009 121-451	CSS300
6PU 009 121-501	CSS407
6PU 009 121-551	CSS318
6PU 009 121-561	CSS316
6PU 009 121-581	CSS317
6PU 009 121-591	CSS200
6PU 009 121-631	CSS918
6PU 009 121-661	CSS1801
6PU 009 121-691	CSS1806
6PU 009 121-781	CSS718
6PU 009 121-791	CSS717
6PU 009 121-801	CSS1603
6PU 009 121-881	CSS323
6PU 009 121-901	CSS330
6PU 009 146 011	CSS100
6PU 009 146-021	CSS1529
6PU 009 146-101	CSS1501
6PU 009 146-111	CSS703
6PU 009 146-121	CSS1305
6PU 009 146-131	CSS905
6PU 009 146-151	CSS707
6PU 009 146-181	CSS1502
6PU 009 146-181	CSS1507
6PU 009 146-211	CSS709
6PU 009 146-251	CSS311
6PU 009 146-401	CSS1701
6PU 009 146-421	CSS1513
6PU 009 146-431	CSS1304
6PU 009 146-441	CSS1804
6PU 009 146-581	CSS326
6PU 009 146-611	CSS1540
6PU 009 163-131	CSS315
6PU 009 163-201	CSS319
6PU 009 163-261	CSS1800
6PU 009 163-271	CSS312
6PU 009 163-291	CSS1514
6PU 009 163-301	CSS923

Referenz-Nr. Reference-No.	BBT-Nr. BBT-No.
-------------------------------	--------------------

6PU 009 163-331	CSS924
6PU 009 163-351	CSS917
6PU 009 163-381	CSS915
6PU 009 163-391	CSS1300
6PU 009 163-401	CSS1303
6PU 009 163-411	CSS1504
6PU 009 163-421	CSS1505
6PU 009 163-431	CSS1515
6PU 009 163-441	CSS1516
6PU 009 163-451	CSS1517
6PU 009 163-461	CSS1518
6PU 009 163-471	CSS1522
6PU 009 163-481	CSS304
6PU 009 163-841	CSS914
6PU 009 163-921	CSS720
6PU 009 163-971	CSS1536
6PU 009 167 -351	CSS313
6PU 009 167-111	CSS1541
6PU 009 167-421	CSS405
6PU 009 169-001	CSS328

<b>Hüco</b>	<b>BBT</b>
-------------	------------

137362	CSS1322
137363	CSS1321
137364	CSS1500
137366	CSS1503
137369	CSS1502
137370	CSS1511
137371	CSS1513
137372	CSS1514
137373	CSS1515
137375	CSS1517
137376	CSS1518
137377	CSS1521
137378	CSS1519
137379	CSS1538
137380	CSS1530
137381	CSS1537
137385	CSS300
137386	CSS324
137388	CSS307
137389	CSS321
137394	CSS1802
137396	CSS717
137397	CSS309
137398	CSS703
138131	CSS407
138160	CSS1701

<b>Hyundai</b>	<b>BBT</b>
----------------	------------

39180-22040	CSS1701
39180-22050	CSS1701
39180-22060	CSS1701
39180-22090	CSS1701
39180-22600	CSS1700

# VERGLEICHSLISTE / CROSS REFERENCE LIST

Referenz-Nr. Reference-No.	BBT-Nr. BBT-No.
-------------------------------	--------------------

39180-23000	CSS1701
39180-23500	CSS1601
39180-23910	CSS1601
39180-26900	CSS1700
39180-27000	CSS1602
39180-2B020	CSS1605
39310-38050	CSS1603
39350-25010	CSS1600

<b>Maserati</b>	<b>BBT</b>
-----------------	------------

470069400	CSS1306
-----------	---------

<b>Mazda</b>	<b>BBT</b>
--------------	------------

70610017	CSS1534
6M8G-6C315	CSS1703
L3G2-18-221	CSS1703
L3K9-18-221A	CSS1703
LF01-18-221	CSS1804
LF01-18-230-Z06	CSS1805
Y401-18-221	CSS1517

<b>Meat &amp; Doria</b>	<b>BBT</b>
-------------------------	------------

87001	CSS1308
87004	CSS1306
87015	CSS1502
87022	CSS1500
87026	CSS1523
87029	CSS1525
87029	CSS1526
87030	CSS1527
87038	CSS903
87042	CSS1528
87044	CSS707
87047	CSS702
87058	CSS913
87059	CSS907
87083	CSS1305
87088	CSS400
87090	CSS905
87092	CSS312
87109	CSS700
87110	CSS906
87114	CSS704
87130	CSS309
87142	CSS703
87143	CSS1000
87145	CSS1304
87148	CSS709
87151	CSS714
87155	CSS1309
87158	CSS311
87159	CSS1307
87162	CSS1520
87163	CSS1508
87164	CSS1509

Referenz-Nr. Reference-No.	BBT-Nr. BBT-No.
-------------------------------	--------------------

87174	CSS1533
87175	CSS1532
87176	CSS1534
87177	CSS1535
87179	CSS1536
87194	CSS315
87206	CSS713
87207	CSS710
87208	CSS708
87209	CSS705
87219	CSS701
87220	CSS1510
87222	CSS1701
87229	CSS1516
87231	CSS1513
87235	CSS319
87239	CSS1700
87240	CSS1805
87243	CSS1522
87245	CSS1518
87245	CSS1518
87247	CSS1801
87248	CSS1514
87249	CSS1800
87250	CSS1515
87262	CSS711
87267	CSS401
87269	CSS404
87277	CSS318
87278	CSS307
87281	CSS306
87282	CSS718
87283	CSS1317
87285	CSS1521
87288	CSS326
87292	CSS1519
87293	CSS1517
87294	CSS1512
87295	CSS1511
87296	CSS1530
87297	CSS1804
87327	CSS323
87331	CSS1318
87332	CSS716
87333	CSS1310
87336	CSS1301
87339	CSS314
87340	CSS1303
87343	CSS328
87344	CSS1300
87373	CSS1541
87377	CSS313
87379	CSS302
87380	CSS303
87382	CSS304

Referenz-Nr. Reference-No.	BBT-Nr. BBT-No.
-------------------------------	--------------------

87389	CSS717
87399	CSS200
87399	CSS402
87401	CSS1540
87407	CSS1531
87413	CSS720
87419	CSS712
87422	CSS902
87423	CSS900
87424	CSS901
87434	CSS1806
87435	CSS407
87437	CSS1537
87440	CSS1602
87451	CSS1538
87453	CSS322
87454	CSS912
87456	CSS1539
87459	CSS321
87460	CSS320
87470	CSS324
87473	CSS1807
87477	CSS330
87480	CSS329
87491	CSS1402
87503	CSS310
87514	CSS918
87516	CSS924
87521	CSS1401
87528	CSS332
87534	CSS919
87550	CSS1601
87566	CSS1543
87567	CSS1542
87571	CSS1322
87572	CSS1321
87574	CSS333
87580	CSS1802
87583	CSS1803
87598	CSS917
87599	CSS922
87605	CSS1604
87645	CSS923
87660	CSS921
87673	CSS673
87674	CSS706
87805	CSS405
87912	CSS715
87955	CSS721
87998	CSS331

<b>Mazda</b>	<b>BBT</b>
--------------	------------

C201-18-221	CSS1800
C201-18-230	CSS1801

# VERGLEICHSLISTE / CROSS REFERENCE LIST

Referenz-Nr. Reference-No.	BBT-Nr. BBT-No.	Referenz-Nr. Reference-No.	BBT-Nr. BBT-No.	Referenz-Nr. Reference-No.	BBT-Nr. BBT-No.
<b>Mercedes</b>	<b>BBT</b>				
003 153 27 28	CSS400	23731-6J966	CSS1604	62 356 66	CSS1300
003 153 28 28	CSS400	23731-6J96B	CSS1604	62 38 098	CSS705
003 153 72 28	CSS401	23731-9X800	CSS709	62 38 101	CSS708
003 153 74 28	CSS401	23731-BC41A	CSS1541	62 38 109	CSS713
003 153 83 28	CSS402	23731-BN700	CSS1536	62 38 110	CSS718
004 153 00 28	CSS404	23731-BN701	CSS1540	62 38 153	CSS716
004 153 07 28	CSS402	23731-BN70A	CSS1536	62 38 216	CSS916
004 153 69 28	CSS402	23731-BN70B	CSS1536	62 38 282	CSS717
272 905 00 43	CSS403	23731-DB000	CSS1540	62 38 376	CSS714
A 003 153 27 28	CSS400	23731-DB00A	CSS1540	62 38 377	CSS702
A 003 153 28 28	CSS400	23750-00Q0A	CSS1536	62 38 393	CSS704
A 003 153 72 28	CSS401	23750-00Q0B	CSS1541	62 38 395	CSS709
A 003 153 74 28	CSS401	23750-00Q0G	CSS1536	62 38 459	CSS710
A 003 153 83 28	CSS402	23750-00Q0M	CSS1536	62 38 685	CSS720
A 003 153 97 28	CSS407	23750-00QAE	CSS1533	62 38 868	CSS719
A 004 153 00 28	CSS404	23750-00QAK	CSS1541	62 386 46	CSS716
A 004 153 07 28	CSS200	23760-00QAB	CSS1540	62 40 359	CSS916
A 004 153 07 28	CSS402	23760-00QAD	CSS1540	90 12 039	CSS712
A 004 153 60 28	CSS403	23798-00QAC	CSS1532	90 357 491	CSS703
A 004 153 69 28	CSS402			90 458 251	CSS711
A 004 153 87 28	CSS405	<b>Opel</b>	<b>BBT</b>	90 458 252	CSS701
A 005 153 13 28	CSS407	12 35 268	CSS1301	90 458 282	CSS701
A 272 905 00 00	CSS405	12 37 183	CSS722	90 483 739	CSS704
A 272 905 00 43	CSS403	12 38 207	CSS706	90 493 864	CSS714
A 272 905 01 43	CSS403	12 38 228	CSS702	90 506 103	CSS702
A 276 905 07 00	CSS406	12 38 268	CSS700	90 520 854	CSS705
A 276 905 07 00 28	CSS406	12 38 385	CSS707	90 520 856	CSS710
A 276 905 12 00	CSS406	12 38 914	CSS711	91 18 150	CSS708
A 607 905 03 00	CSS1537	12 38 915	CSS701	91 18 368	CSS713
A 642 153 07 28	CSS405	12 38 983	CSS703	91 183 74	CSS718
A 642 905 00 00	CSS405	12 47 060	CSS1301	91 74 621	CSS702
		12 474 32	CSS716	93 171 450	CSS712
		12 49 089	CSS700	93 178 046	CSS716
		12 49 111	CSS721		
		12 49 112	CSS715	<b>Peugeot</b>	<b>BBT</b>
		44 02 560	CSS1534	1920 4A	CSS1502
		44 15 077	CSS1540	1920 5T	CSS1508
		44 21 645	CSS1540	1920 5V	CSS1520
		24 435 096	CSS717	1920 6T	CSS1509
		24 445 139	CSS701	1920 7N	CSS1513
		25 195 551	CSS700	1920 7P	CSS1515
		25 195 555	CSS721	1920 7V	CSS1510
		25 195 556	CSS715	1920 8S	CSS1514
		55 216 241	CSS716	1920 8W	CSS1511
		55 562 744	CSS706	1920 9C	CSS1516
		55 565 708	CSS721	1920 AE	CSS1512
		55 565 709	CSS715	1920 AV	CSS1521
		55 566 932	CSS722	1920 AW	CSS1518
		55 571 994	CSS700	1920 C3	CSS1500
		62 35 604	CSS914	1920 EJ	CSS1519
		62 35 664	CSS1317	1920 F5	CSS1501
		62 35 751	CSS721	1920 FP	CSS1522
		62 35 752	CSS715	1920 J5	CSS1502
		62 356 45	CSS1303	1920 L1	CSS1503
		62 356 65	CSS1301	1920 PW	CSS1538
<b>Mini</b>	<b>BBT</b>				
12 14 1 485 845	CSS921				
13 62 7 805 004	CSS1517				
13 62 7 808 449	CSS1538				
<b>Mitsubishi</b>	<b>BBT</b>				
J5T23381	CSS716				
MD 321888	CSS1528				
<b>Nissan</b>	<b>BBT</b>				
01436-00QAB	CSS1534				
22630-00QAG	CSS1540				
23731-5M010	CSS1604				
23731-5M015	CSS1604				
23731-5M016	CSS1604				
23731-6J900	CSS1604				
23731-6J902	CSS1604				
23731-6J905	CSS1604				
23731-6J906	CSS1604				
23731-6J90A	CSS1604				
23731-6J90B	CSS1604				
23731-6J90C	CSS1604				

# VERGLEICHSLISTE / CROSS REFERENCE LIST

Referenz-Nr. Reference-No.	BBT-Nr. BBT-No.
-------------------------------	--------------------

1920 QN	CSS1510
1920 QS	CSS1539
1920 W9	CSS1506
1920 Z3	CSS1507
5918 81	CSS1506
5918 87	CSS1500
5918 90	CSS1501
5918 93	CSS1505
5918 94	CSS1504
91 541 075	CSS1501
96 037 097	CSS1501
96 067 317	CSS1501
96 067 317 80	CSS1501
96 068 168	CSS1501
96 068 168 80	CSS1501
96 068 172	CSS1501
96 068 172 80	CSS1501
96 131 733	CSS1503
96 168 062 80	CSS1505
96 168 063 80	CSS1504
96 222 098	CSS1501
96 222 098 80	CSS1501
96 285 598 80	CSS1510
96 285 599 80	CSS1510
96 291 398 80	CSS1511
96 296 843 80	CSS1509
96 305 956 80	CSS1511
96 328 897 80	CSS1514
96 346 055 80	CSS1512
96 346 059 80	CSS1512
96 374 659 80	CSS1518
96 374 660 80	CSS1521
96 374 991 80	CSS1519
96 399 998 80	CSS1518
96 399 999	CSS1521
96 399 999 80	CSS1521
96 406 277 80	CSS1522
96 468 233 80	CSS1522
96 605 820 80	CSS1519
96 643 873 80	CSS1538
96 647 321 80	CSS1539
96 742 659 80	CSS1546
96 752 267 80	CSS1548
96 773 087 80	CSS1545
96 775 394 80	CSS1547
98 009 914 80	CSS1545

<b>Porsche</b>	<b>BBT</b>
996 606 106 02	CSS200

<b>Renault</b>	<b>BBT</b>
23 731 013 5R	CSS1544
23 73 1DB 00A	CSS1540
60 01 545 512	CSS1536
60 25 003 234	CSS1523

Referenz-Nr. Reference-No.	BBT-Nr. BBT-No.
-------------------------------	--------------------

60 25 403 357	CSS1531
77 00 100 566	CSS1536
77 00 101 969	CSS1532
77 00 101 970	CSS1534
77 00 101 971	CSS1533
77 00 103 486	CSS1530
77 00 108 073	CSS1535
77 00 109 055	CSS1536
77 00 130 069A	CSS1534
77 00 722 143	CSS1524
77 00 728 637	CSS1527
77 00 728 638	CSS1529
77 00 732 300	CSS1526
77 00 739 591	CSS1523
77 00 739 787	CSS1525
77 00 739 789	CSS1524
77 00 739 791	CSS1525
77 00 739 792	CSS1526
77 00 739 793	CSS1527
77 00 739 794	CSS1527
77 00 747 548	CSS1529
77 00 748 442	CSS1529
77 00 850 591	CSS1523
77 00 855 719	CSS1529
77 00 859 831	CSS1528
77 00 875 184	CSS1532
77 01 058 077	CSS1540
77 01 349 559	CSS1524
82 00 033 686	CSS1540
82 00 038 472	CSS1530
82 00 187 804	CSS1541
82 00 285 798	CSS1540
82 00 370 572	CSS1530
82 00 373 588	CSS1541
82 00 396 919	CSS1532
82 00 396 919	CSS1532
82 00 434 068	CSS1541
82 00 436 025	CSS1532
82 00 436 025	CSS1532
82 00 439 315	CSS1536
82 00 468 645	CSS1534
82 00 468 647	CSS1535
82 00 567 414	CSS1540
82 00 643 171	CSS1532
82 00 647 554	CSS1534
82 00 688 406	CSS1536
82 00 691 795	CSS1541
82 00 709 844	CSS1530
82 00 746 497	CSS1542
82 00 772 182	CSS1543
82 00 789 528	CSS1530
82 00 885 209	CSS1537
82 01 040 861	CSS1536
82 01 040 861	CSS1536
96 22 209 880	CSS1506

Referenz-Nr. Reference-No.	BBT-Nr. BBT-No.
-------------------------------	--------------------

<b>Rolls-Royce</b>	<b>BBT</b>
PF100607PA	CSS311

<b>Saab</b>	<b>BBT</b>
42 27 203	CSS707
47 72 232	CSS709

<b>SMP (Europe)</b>	<b>BBT</b>
17005	CSS200
17011	CSS1802
17057	CSS918
17061	CSS915
17120	CSS1322
17131	CSS405
17138	CSS706
17151	CSS715
17152	CSS721
17160	CSS722
17211	CSS308
17227	CSS1321
17230	CSS333
17235	CSS700
17273	CSS331
17288	CSS1548
17297	CSS1803
17299	CSS921
18751	CSS1306
18756	CSS1526
18758	CSS1500
18764	CSS707
18772	CSS1527
18796	CSS1502
18799	CSS704
18805	CSS1305
18808	CSS909
18813	CSS908
18814	CSS312
18816	CSS907
18821	CSS906
18826	CSS1000
18830	CSS1307
18833	CSS1304
18835	CSS703
18838	CSS709
18839	CSS714
18843	CSS311
18860	CSS309
18873	CSS1520
18874	CSS1509
18878	CSS1535
18880	CSS1536
18890	CSS1308
18894	CSS315
18907	CSS710

# VERGLEICHSLISTE / CROSS REFERENCE LIST

Referenz-Nr. Reference-No.	BBT-Nr. BBT-No.
18908	CSS708
18909	CSS705
18912	CSS325
18918	CSS326
18930	CSS1805
18938	CSS1700
18939	CSS1508
18940	CSS1701
18942	CSS713
18944	CSS1801
18945	CSS1800
18946	CSS1522
18951	CSS1516
18952	CSS1513
18953	CSS1514
18954	CSS1513
18955	CSS1531
18958	CSS1518
18958	CSS1518
18959	CSS1521
18960	CSS701
18961	CSS702
18962	CSS711
18965	CSS1534
18986	CSS307
19000	CSS1804
19001	CSS1603
19003	CSS914
19004	CSS1540
19008	CSS306
19010	CSS1317
19011	CSS1310
19016	CSS314
19019	CSS1303
19021	CSS402
19023	CSS1300
19026	CSS1318
19028	CSS1512
19029	CSS1510
19031	CSS1517
19032	CSS1511
19033	CSS1505
19034	CSS1504
19035	CSS1525
19037	CSS1528
19042	CSS318
19043	CSS1519
19044	CSS718
19046	CSS712
19047	CSS716
19048	CSS323
19049	CSS1301
19050	CSS328
19056	CSS717
19062	CSS905

Referenz-Nr. Reference-No.	BBT-Nr. BBT-No.
19066	CSS302
19067	CSS303
19069	CSS304
19072	CSS1806
19077	CSS1807
19078	CSS720
19080	CSS400
19097	CSS1538
19115	CSS912
19118	CSS407
19125	CSS913
19127	CSS1602
19128	CSS1601
19131	CSS901
19140	CSS902
19148	CSS1541
19168	CSS903
19169	CSS924
19171	CSS900
19179	CSS404
19182	CSS1402
19183	CSS916
19184	CSS910
19187	CSS919
19206	CSS1401
19251	CSS1537
19257	CSS324
19259	CSS322
19260	CSS320
19261	CSS313
19270	CSS922
19273	CSS923
19289	CSS332
19086K	CSS1532
19089K	CSS1533
<b>Suzuki</b>	<b>BBT</b>
33220-84A00-000	CSS1540
33220-84A10-000	CSS1540
35442-84CT1-000	CSS1536
35442-86CA0-000	CSS1536
35442-86CA1-000	CSS1536
<b>Toyota</b>	<b>BBT</b>
SU001-00640	CSS1517
SU001-00641	CSS1519
SU001-00873	CSS1538
90080-19026	CSS914
90919-05055	CSS914
<b>VAG</b>	<b>BBT</b>
021 907 319 B	CSS319
030 907 601	CSS306
030 907 601	CSS300
030 907 601 D	CSS300

Referenz-Nr. Reference-No.	BBT-Nr. BBT-No.
030 907 601 D	CSS306
030 907 601 E	CSS300
034 905 381	CSS312
034 905 381 A	CSS312
035 905 381 B	CSS312
036 907 601	CSS307
036 907 601 A	CSS307
036 907 601 B	CSS307
036 907 601 C	CSS307
036 907 601 D	CSS307
036 907 601 E	CSS307
037 906 433 A	CSS309
037 906 433 C	CSS309
038 907 319	CSS315
090 307 601 E	CSS300
02T 906 207	CSS320
02T 906 207 C	CSS320
03C 906 433 A	CSS322
03C 906 433 B	CSS322
03C 906 433 E	CSS322
03D 906 433	CSS304
03D 907 601	CSS306
03G 957 147	CSS329
03G 957 147 A	CSS330
03G 957 147 B	CSS329
03G 957 147 C	CSS330
04C 907 601	CSS308
04C 907 601 A	CSS308
04L 907 601	CSS331
04L 907 601 A	CSS331
045 906 433 B	CSS322
045 957 147 D	CSS329
058 905 161 B	CSS318
06A 905 161 A	CSS323
06A 905 161 B	CSS316
06A 905 161 C	CSS316
06A 906 433 B	CSS325
06A 906 433 C	CSS311
06A 906 433 E	CSS314
06A 906 433 F	CSS310
06A 906 433 G	CSS325
06A 906 433 K	CSS326
06A 906 433 L	CSS325
06A 906 433 N	CSS325
06B 905 163 A	CSS303
06C 905 163 B	CSS302
06E 905 163	CSS332
06H 905 163 A	CSS324
06H 906 207	CSS333
06H 906 433	CSS313
070 607 601A	CSS301
070 907 601	CSS301
070 907 601 A	CSS301
070 907 601 B	CSS301
078 905 161 A	CSS317

# VERGLEICHSLISTE / CROSS REFERENCE LIST

Referenz-Nr. Reference-No.	BBT-Nr. BBT-No.
-------------------------------	--------------------

078 905 161 C	CSS317
078 905 375	CSS312
078 905 381	CSS312
078 905 381 A	CSS312
07K 907 601	CSS321
07K 907 601 A	CSS321
07L 905 163	CSS324
07L 905 163 A	CSS324
07L 905 163 B	CSS324
07L 905 163 C	CSS324

<b>VDO</b>	<b>BBT</b>
------------	------------

2910000216800	CSS922
5WK90051Z	CSS901
5WK96011Z	CSS900
A2C59515058	CSS1543
A2C59515059	CSS1542
S103557002Z	CSS903
S105757001Z	CSS1534
S107542002Z	CSS1801
S1075430027	CSS1800
S119044012Z	CSS923
S119915001Z	CSS1532
S119974001Z	CSS1533
S119976001Z	CSS1535

<b>Vemo</b>	<b>BBT</b>
-------------	------------

V10-72 1158	CSS330
V10-72 1158-1	CSS330
V10-72-0119	CSS200
V10-72-0938-1	CSS311
V10-72-0977	CSS317
V10-72-0978	CSS316
V10-72-0979	CSS323
V10-72-0994	CSS315
V10-72-1002	CSS325
V10-72-1003	CSS326
V10-72-1007	CSS307
V10-72-1008	CSS319
V10-72-1031	CSS328
V10-72-1041	CSS303
V10-72-1046	CSS313
V10-72-1090	CSS332
V10-72-1099	CSS301
V10-72-1109	CSS322
V10-72-1118	CSS321
V10-72-1120	CSS320
V10-72-1209	CSS324
V10-72-1244	CSS329
V10-72-1244-1	CSS329
V10-72-1319	CSS308
V20-72-0074	CSS923
V20-72-0402	CSS903
V20-72-0403	CSS913
V20-72-0405	CSS907

Referenz-Nr. Reference-No.	BBT-Nr. BBT-No.
-------------------------------	--------------------

V20-72-0411	CSS900
V20-72-0417	CSS908
V20-72-0418	CSS905
V20-72-0423	CSS909
V20-72-0431	CSS901
V20-72-0432-1	CSS906
V20-72-0471-1	CSS902
V20-72-0474	CSS904
V20-72-0505	CSS924
V20-72-0516	CSS912
V22-72-0018	CSS1511
V22-72-0024	CSS1519
V22-72-0028	CSS1510
V22-72-0029	CSS1509
V24-72-0011	CSS1305
V24-72-0071	CSS1537
V24-72-0091	CSS1310
V24-72-0186	CSS1322
V24-72-0187	CSS1321
V25-72-0039	CSS1805
V25-72-0087	CSS720
V25-72-1027	CSS1804
V25-72-1180	CSS1802
V25-72-1182	CSS1803
V30-72-0111	CSS400
V30-72-0115	CSS401
V30-72-0119	CSS402
V30-72-0702	CSS407
V40-72-0303	CSS704
V40-72-0305	CSS702
V40-72-0317	CSS714
V40-72-0343	CSS711
V40-72-0354	CSS709
V40-72-0359	CSS713
V40-72-0360	CSS710
V40-72-0362	CSS705
V40-72-0371	CSS716
V40-72-0397	CSS712
V40-72-0427	CSS1317
V40-72-0590	CSS706
V40-72-0615	CSS721
V40-72-0616	CSS715
V40-72-0617	CSS700
V40-72-0618	CSS722
V42-72-0027	CSS1538
V42-72-0029	CSS1539
V46-72-0011	CSS1532
V46-72-0012	CSS1533
V46-72-0013	CSS1535
V46-72-0015	CSS1534
V46-72-0019	CSS1530
V46-72-0020	CSS1536
V46-72-0074	CSS1541
V46-72-0116	CSS1537
V46-72-0122	CSS1543

Referenz-Nr. Reference-No.	BBT-Nr. BBT-No.
-------------------------------	--------------------

V51-72-0037	CSS1401
V51-72-0038	CSS1402
V52-72-0001	CSS1701
V52-72-0225	CSS1605

<b>Velvo</b>	<b>BBT</b>
--------------	------------

1 389 399	CSS100
1 389 3995	CSS100
2 719 49	CSS100
2 719 490	CSS100
3 065 8179	CSS1804
3 065 8182	CSS1805
3 065 8182	CSS1805
3 071 1104	CSS1517
3 071 1660	CSS1800
3 071 1663	CSS1801
3 204 141	CSS1523
3 204 1410	CSS1523
3 209 8261	CSS1525
3 547 8478	CSS100
8 631 533	CSS914

## I. Allgemeines

1. Diese Bedingungen gelten für alle Lieferungen, gleichgültig ob Kauf oder Werklieferungsverträge. Wir liefern nur zu diesen Bedingungen, die zugleich auch für sämtliche künftigen Vertragsbeziehungen gelten, auch wenn sie nicht ausdrücklich einbezogen werden.

2. Geschäfts- und Einkaufsbedingungen von Vertragspartnern widersprechen wir hiermit ausdrücklich. Diese werden keinesfalls Vertragsgegenstand. Abweichende Regelungen gelten nur dann, wenn sie von uns schriftlich vor Vertragsabschluss bestätigt worden sind. Wir sind nicht verpflichtet, Vertragsformblättern oder Geschäftsbedingungen von Vertragspartnern förmlich zu widersprechen und zwar auch dann nicht, wenn in diesen Geschäftsbedingungen die Gültigkeit derselben als ausdrückliche Bedingung für den Geschäftsabschluss genannt ist. Wir erklären, ausschließlich aufgrund der vorliegenden Geschäftsbedingungen Verträge abschließen zu wollen.

3. Erfüllungsort für beide Teile ist unser Sitz, Gerichtsstand nach unserer Wahl Ansbach oder Nürnberg.

4. Die Verantwortung für die Auswahl der Produkte und die mit ihnen beabsichtigten Zwecke liegt ausschließlich beim Kunden, es sei denn, wir geben im Einzelfall besondere schriftliche Zusicherungen oder Garantien ab.

5. Wir sind berechtigt, bei erstmaliger Geschäftsbeziehung vor Auftragsübernahme geschäftliche Referenzen anzufordern, insbesondere eine Bankverbindung mit einem Ansprechpartner.

## II. Preise

1. Unsere Preise verstehen sich, soweit nicht schriftlich anders vereinbart, ab Weihenzell, ausschließlich Verpackung und Verladung und Transport rein netto, zuzüglich der gesetzlichen Mehrwertsteuer.

2. Wir sind berechtigt, unsere Rechnungen auf elektronischem Wege zur versenden.

## III. Zahlungsstörungen

1. Gerät unser Kunde mit einer Zahlungsverpflichtung in Rückstand, so schuldet er Zinsen in Höhe von 8%-Punkten über dem jeweiligen Basiszinssatz.

2. Wir sind zum Vertragsrücktritt berechtigt, wenn sich die wirtschaftlichen Verhältnisse des Kunden verschlechtern oder schlechte Verhältnisse bekanntwerden. Ebenso, wenn Zahlungsverpflichtungen länger als zwei Wochen trotz Mahnung nicht erfüllt werden. Ist Zahlung in Teilbeträgen gestattet, so wird der Rest sofort fällig, wenn Zahlungstermine um mehr als zwei Wochen überschritten werden.

Bei Abrufaufträgen sind wir berechtigt, vom nicht erfüllten Teil der Abrufvereinbarung zurückzutreten und Schadensersatz wegen Nichterfüllung der gesamten Abrufvereinbarung zu verlangen, wenn der Kunde mit der Abnahme auch nur eines Teils der vereinbarten Mengen in Verzug gerät. Gleiches gilt, wenn der Kunde mit der Bezahlung bisheriger Lieferungen in Verzug und nicht in der Lage ist, weitere Leistungen nur gegen Vorauszahlungen oder Sicherheitsleistung entgegenzunehmen.

3. Aufrechnung mit bestrittenen und nicht rechtskräftigen Gegenansprüchen ist nicht statthaft. Gleiches gilt für das Zurückbehaltungsrecht.

## IV. Schadensersatz

Erfüllt der Kunde einen Vertrag nicht oder können wir von unserem Rücktrittsrecht Gebrauch machen, so erhalten wir als Entschädigung unseres entgangenen Gewinns einen pauschalen Schadensersatz in Höhe von 25% des vereinbarten Preises zuzüglich des Entgelts für bereits erbrachte Arbeitsleistungen und Materialverbrauch ohne Nachweis, unbeschadet des Rechts beider Seiten, einen höheren oder niedrigeren Schaden nachzuweisen.

## V. Eigentumsvorbehalt

1. Sämtliche Lieferungen bleiben bis zur vollständigen Zahlung unserer sämtlichen Forderungen aus der Geschäftsbeziehung unser Eigentum. Sofern im Einzelfall eine Übersicherung von mehr als 25% eintreten sollte, verpflichten wir uns zur Freigabe von Gegenständen oder Forderungen nach Auswahl des Kunden.

2. Veräußerung und Verarbeitung von Vorbehaltsware ist zulässig. Insofern tritt uns der Kunde die daraus entstehenden Forderungen gegen Dritte bereits jetzt ab. Der Kunde ist widerruflich berechtigt, die Forderungen einzuziehen.

3. Der Eigentumsvorbehalt berechtigt uns im Falle des Zahlungsverzuges zur sofortigen Wiederinbesitznahme oder Geltendmachung der Rechte aus der Abtretung. Der Kunde verzichtet auf die Einwendung der unzulässigen Eigenmacht und ermächtigt uns von vornherein zum freihändigen Verkauf der Gegenstände auf seine Kosten.

4. Wird die Vorbehaltsware vom Käufer verarbeitet, so wird vereinbart, dass die Verarbeitung im Namen und für Rechnung des Verkäufers als Hersteller erfolgt und der Verkäufer unmittelbar das Eigentum oder – wenn die Verarbeitung aus Stoffen mehrerer Eigentümer erfolgt oder der Wert der verarbeitenden Sache höher ist als der Wert der Vorbehaltsware – das Miteigentum (Bruchteilseigentum) an der neu geschaffenen Sache im Verhältnis des Werts der Vorbehaltsware zum Wert der neu geschaffenen Sache erwirbt. Für den Fall, dass kein solcher Eigentumserwerb beim Verkäufer eintreten sollte, überträgt der Käufer bereits jetzt sein künftiges Eigentum oder – im oben genannten Verhältnis – Miteigentum an der neu geschaffenen Sache zur Sicherheit an den Verkäufer.

Wird die Vorbehaltsware mit anderen Sachen zu einer einheitlichen Sache verbunden oder untrennbar vermischt und ist eine der anderen Sachen als Hauptsache anzusehen,

so überträgt der Verkäufer, soweit die Hauptsache ihm gehört, dem Käufer anteilig das Miteigentum an der einheitlichen Sache in dem in Satz 1 genannten Verhältnis.

## VI. Übergabe

1. Der Versand erfolgt stets auf Rechnung und Gefahr des Kunden. Mit der Übergabe an den Spediteur/Frachtführer geht die Gefahr über, spätestens beim Verlassen unseres Geschäftsgrundstücks.

2. Bei Export der gekauften Ware ist der Kunde verpflichtet, die notwendigen Export- und Zollbewilligungen, sowie sonstigen Einfuhrunterlagen auf seine Kosten zu beschaffen. Wir haften nicht für die Zulässigkeit der Ausfuhr der Ware und deren Übereinstimmung mit besonderen rechtlichen und technischen Vorschriften des Importlandes.

3. Eine Versicherung der Ware für den Transport erfolgt durch uns nur bei Vorliegen eines Auftrags des Kunden.

## VII. Haftung

1. Der Kunde ist verpflichtet, bei Meidung des vollständigen Rechtsverlustes die Vollständigkeit und Mangelfreiheit der Ware sofort nach Entgegennahme zu überprüfen und Beanstandungen schriftlich spätestens am nächsten Tage mitzuteilen. Bei berechtigten Mängelrügen haben wir das Recht, die Ware zurückzunehmen und unverzüglich Ersatz zu leisten.

2. Abweichungen in der Beschaffenheit der gelieferten Gegenstände können nicht beanstandet werden, sofern sie handelsüblich und für den vorgesehenen Gebrauch nicht erheblich sind. Jegliche Eingriffe von außen, die mit einem geltend gemachten Mangel im Zusammenhang stehen, heben die Gewährleistung auf.

3. Wir können wegen Nichterfüllung oder Verzugs nur in Anspruch genommen werden, wenn uns Vorsatz oder grobe Fahrlässigkeit nachgewiesen werden kann. Gleiches gilt auch für Mangelfolgeschäden, für die wir ansonsten nicht haften. Ist uns Ersatz oder Nachbesserung, zu der wir ebenfalls berechtigt sind, in angemessener Frist nicht möglich, so kann der Kunde Rückgängigmachung des Vertrages verlangen. Die Haftungsbeschränkung gilt nicht bei Personenschäden oder wenn es sich um eine Verletzung vertragswesentlicher Pflichten handelt. Vertragswesentlich sind die Verpflichtung zur rechtzeitigen Lieferung sowie Beratungs-, Schutz- und Obhutspflichten, die dem Kunden die vertragsgemäße Verwendung des Liefergegenstandes ermöglichen sollen oder den Schutz von Leib oder Leben von Personal des Kunden oder den Schutz von dessen Eigentum vor erheblichen Schäden bezwecken. Im Falle einer Haftung für einfache Fahrlässigkeit ist unsere Ersatzpflicht für Sachschäden und daraus resultierende weitere Vermögensschäden auf einen Betrag in Höhe der derzeitigen Deckungssumme unserer Produkthaftpflichtversicherung oder sonstigen Haftpflichtversicherung beschränkt, auch wenn es sich um eine Verletzung vertragswesentlicher Pflichten handelt.

4. Ansprüche gegen uns, gleichgültig aus welchem Rechtsgrund, mit Ausnahme bei Personenschäden verjähren insoweit innerhalb von 12 Monaten, soweit nicht eine kürzere gesetzliche Verjährung gilt.

5. Unser Kunde ist gehalten, gelieferte Gegenstände vor einer Weiterverarbeitung sorgfältig zu überprüfen und stellt uns deshalb von Produkthaftpflichtansprüchen frei.

6. Rücksendungen dürfen nur nach vorheriger Einwilligung durch BBT erfolgen.

## VIII. Lieferungen

1. Wir streben termingerechte Auslieferung an. Liefertermine sind allerdings nur verbindlich, wenn sie schriftlich kalendermäßig vereinbart sind. Können wir gleichwohl nicht liefern, so ist uns zwei Wochen nach Ablauf des Liefertermins eine schriftliche Nachfrist zu setzen, die mindestens einen Monat betragen muss.

2. Eine angemessene Lieferzeitverlängerung tritt immer bei unvorhergesehenen Hindernissen, auch bei Änderungs- oder Ergänzungswünschen des Kunden, die die Art des Produkts oder den Umfang der Lieferung betreffen, ein.

## IX. Rechtswahl

Sämtliche Rechtsbeziehungen unterstehen ausschließlich deutschem Recht. Die Anwendung internationaler Rechtsvorschriften, insbesondere die Anwendung des UN-Kaufrechts ist ausgeschlossen.

## X. Sonstiges

1. Wenn in diesen Geschäftsbedingungen Schriftform genannt ist, so ist darunter auch Telefax und E-Mail (mit Eingangs- oder Lesebestätigung) zu sehen.

2. Es wird vereinbart, dass mündliche Nebenabreden zu Verträgen nur wirksam sind, wenn sie schriftlich bestätigt werden. Ein Verzicht auf die Einhaltung dieser Vorschrift setzt Schriftform voraus.

3. Wir behalten uns vor, nicht in deutscher und englischer Sprache abgegebene Willenserklärungen als nicht erfolgt anzusehen.

4. Sollte eine oder mehrere Bestimmungen dieser Bedingungen ganz oder teilweise unwirksam oder nichtig sein oder werden, so wird dadurch die Wirksamkeit des Bedingungswerks im Übrigen nicht berührt. Der Kunde und wir sind in diesem Fall gehalten, die betreffende Bestimmung durch eine wirksame Regelung zu ersetzen, die dem gewollten wirtschaftlichen Zweck am nächsten kommt. Gleiches gilt im Falle einer Lücke.

## I. General

1. These conditions subject to all deliveries, no matter if purchase or order acceptance ex works. We only deliver to these conditions, which are at the same time valid for all further business agreements, even if they are not included especially.

2. We herewith contradict business and purchasing conditions of contract partners. These will under no circumstances become object of agreement. Deviations from our contracts only apply if confirmed by us in writing before conclusion of contract. We are not obliged to contradict the contract forms or general terms and conditions of the customer, even not if the validity of the terms and conditions is mentioned as an express condition for the business transaction. We (herewith) declare that we exclusively intend to conclude contracts on the basis of the present terms and conditions.

3. Place of settlement for both parties is our place, place of jurisdiction is, chosen by us, Ansbach or Nuernberg.

4. The responsibility for the selection of goods and the intended purpose for them is up to the customer. In single cases we give special written assurances or guarantees.

5. We are entitled to request business references at the first business contact before acceptance of order. This means in particular bank details and a contact person.

## II. Prices

1. If not agreed otherwise in writing, our prices are valid net ex Weihenzell exclusive lost for packing, despatch and transport.

2. We are entitled to send our invoices by electronic means.

## III. Delays in Payment

1. If our customer gets in delays with payment obligations, he owes us interests of 8 % over the basic rate of interest at that time.

2. We are entitled to resign from the contract if our customers' economic circumstances deteriorate or worse circumstances get public, just as if payment obligation is not fulfilled within 2 weeks despite of reminder. If payment is allowed in partial amounts, the rest will get due immediately after payment dates are exceeded more than 2 weeks. If the customer gets in delay with the purchase, even of a part, of the agreed quantities of orders on call, we are entitled to resign from the not fulfilled part of the agreement on call and to demand compensations because of not accomplishing the complete agreement on call. The same applies if the customer gets in delay with the payment of previous deliveries and is not able to accept further services only against advance payments and purchaser security.

3. Settlements in account with not agreed, unclear or not valid demands are not permitted.

## IV. Compensation

If the customer does not fulfil a contract or if we can use our right to resign from the contract, we get a lump sum of 25 % from the agreed price for compensation of our lost profit in addition to already effected labour cost and material used, without proof not having the right of both sides to proof a higher or lesser damage.

## V. Reservation of Ownership

1. Goods supplied remain our property until payment of all our demands under the business contract with the customer has been received.

2. Sale and manufacturing of goods with reservation is admitted. In so far the customer withdraws the arising demands against third parties already now. The customer is revocably entitled to draw in the demands.

3. The reservation of property entitles us to the immediate re-taking of possession in case of payment delays. The customer resigns the objection and authorizes us from the beginning to sell the goods on his cost.

4. If the goods subject to reservation are processed by the customer then it is agreed that the processing is done in the name and for account of the supplier as manufacturer and the supplier shall acquire the ownership directly or – if the processing is of material from several owners or if the value of the processed item exceeds that of the goods subject to reservation – the co-ownership (fractional ownership) of the newly created item in the ratio of the goods subject to reservation to the value of the newly created goods. In case that no such acquisition of property should occur for the supplier, the customer shall henceforth transfer his future property or – in the above relation – co-ownership of the newly created item to the supplier's security. If the goods subject to reservation are combined or inseparably mixed with other goods to a single item and if one of the other can be considered as the main item, then the supplier shall, insofar as the main item belongs to him, transfer the co-ownership proportionally to the customer of the uniform item in the ratio stated in sentence 1.

## VI. Transfer

1. Goods are always forwarded at purchaser's risk and charge. With transfer to the forwarder the risk changes sides, at latest leaving our business site.

In case the purchased goods shall be exported, the customer shall be obliged to obtain the necessary authorisations for export and customs as well as other importing documents at his own expenses. We are not liable for the admissibility of the exportation of the goods and its accordance with particular legal and technical regulations of the importing country.

2. An insurance for the goods during transport is only made by us if we have been received an order by the customer.

## VII. Responsibility

1. The customer is obliged to check completeness and condition of goods immediately after receipt and to inform us in writing about claims on the next day at latest, otherwise warranty expires. If notices of defects are justified, we have the right to take the goods back and supply a replacement immediately.

2. Discrepancies in the condition of the delivered goods cannot be objected as long as they are customary and for the intended purpose not considerable. Manipulation, which is in a relation with a notified claim, liability also expires.

3. Claim for non-accomplishment or delay is only possible, if we can be proved intention or coarse negligence. This also applies to damages in sequence to deficiencies. If we are not in a position to supply replacement or improvement – to which we are also entitled – within a reasonable period of time, the customer can require the cancellation of the contract. The limitation of liability shall not apply to personal injury or to violation of essential contractual duties. The obligation to deliver in time is essential as well as the duties to advice, protect and care which shall enable the customer to use the delivery item according to agreement or contribute to the protection of life and limb of the customer's personnel or to the protection of its title against substantial damage. Our liability to pay compensation for property damage and further resulting financial losses is limited to an amount of the current sum insured in the event of liability for simple negligence, even if it is a violation of essential contractual duties.

4. Claims against us no matter the cause become prescriptive after 12 month with exception of personal injury.

5. Our customer is obliged to check delivered goods carefully before manufacturing or using them. Therefore we are released from product liability claims.

6. No merchandise is to be returned to us without agreement.

## VIII. Deliveries

1. We endeavour to deliver on time. Delivery dates are only binding if they are agreed with a firm date in writing. If we are nevertheless not able to deliver, a written set term of at least 4 weeks has to be agreed. This has to take place 2 weeks after expiration of the delivery date.

2. A suitable extension of the delivery time always takes place because of unexpected obstacles, force majeure and also due to alterations or additional requirements of the customer which concern the type of the products and the scope of the delivery.

## IX. Choice of law

All legal relations are under the jurisdiction of German law. The application of international legislations is excluded, in particular the application of the UN Sales Convention.

## X. Others

1. If written form is mentioned in these terms and conditions, fax and e-mail is meant by this as well (including acknowledgement of receipt and read confirmation).

2. It is agreed that all verbal agreements besides to the contracts are only effective, if they are confirmed in writing. A renunciation to fulfil this regulation has to be done in writing.

3. We reserve the right to consider declaratory acts, which are not given in German or English language, as not taken place.

4. Should one or more provisions of this agreement be totally or partially legally ineffective or invalid, the validity of the terms and conditions shall thereby not be affected. In this case, the customer and us are obliged to replace the concerning provision with an effective regulation which come closest to the intended economic purpose. The same applies in the event of a gap.

**IGNITION COILS**

**CAMSHAFT - CRANKSHAFT SENSORS**

**IGNITION CABLE SETS**

**MASS AIR FLOW SENSORS**

**MAP SENSORS**

**FUEL SUPPLY UNITS**

**OXYGEN SENSORS**

Ignition  
1  
2  
3